

**aluminorte** Desde 1986  
alumínio e acessórios

Soluções para  
alumínio desde  
1986

**SP-EURO45**  ®

Sistema  
**Aluminorte**  
Cátalogo completo

VERSÃO VI - Abril 2024

# SP-EURO45



## Rw= 36 dB

NA JANELA INTEGRADA COM VIDRO DE 10 MM



### EXCELENTE PERFORMANCE EM TERMOACÚSTICA



### SISTEMA DE ALTO PADRÃO IDEAL PARA GRANDES VÃOS



### OPÇÃO ELEVÁVEL

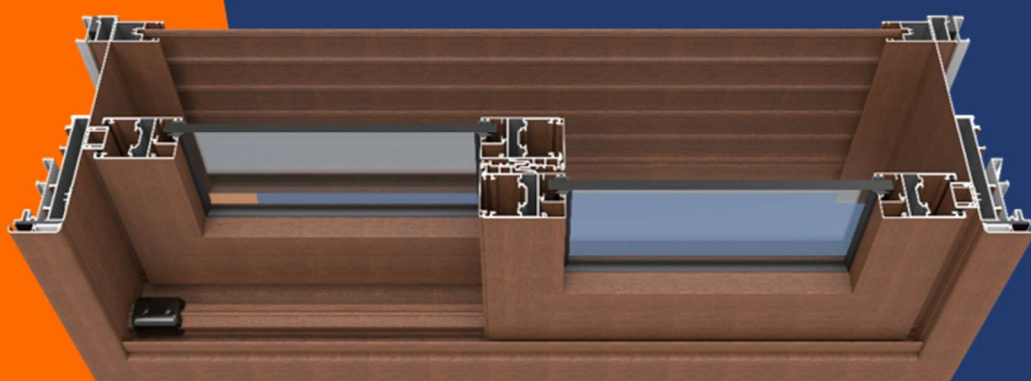

**aluminorte** Desde 1986  
alumínio e acessórios

ÍNDICE DE PERFIS	01
PERFIS	02
COMPONENTES	26
TABELA DE VIDROS	31
TIPOLOGIAS	37
NORMAS	40
DIAGRAMA DE PRESSÃO	42
PROJETOS ORIENTATIVOS	55
PLANILHA DE ENSAIOS	60



CÓDIGO	PESO	PÁG	CÓDIGO	PESO	PÁG
45EC - 091	2,169 Kg/m	13	45EC - 248	1,099 Kg/m	19
45EC - 095	0,488 Kg/m	5	45EC - 249	0,785 Kg/m	19
45EC - 096	0,478 Kg/m	5	45EC - 250	1,545 Kg/m	20
45EC - 100	0,693 Kg/m	7	45EC - 251	0,140 Kg/m	18
45EC - 133	0,648 Kg/m	12	45EC - 252	0,511 Kg/m	18
45EC - 200	0,532 Kg/m	2	45EC - 253	2,247 Kg/m	21
45EC - 201	0,511 Kg/m	2	45EC - 254	1,076 Kg/m	17
45EC - 203	0,162 Kg/m	21	45EC - 255	0,657 Kg/m	17
45EC - 204	0,225 Kg/m	2	45EC - 258	0,574 Kg/m	16
45EC - 205	0,151 Kg/m	2	45EC - 263	1,151 Kg/m	3
45EC - 208	0,207 Kg/m	6	45EC - 267	1,010 Kg/m	15
45EC - 209	0,345 Kg/m	6	45EC - 268	0,846 Kg/m	15
45EC - 210	0,288 Kg/m	17	45EC - 269	1,117 Kg/m	16
45EC - 212	0,274 Kg/m	6	45EC - 270	1,737 Kg/m	9
45EC - 219	2,306 Kg/m	3	45EC - 271	2,235 Kg/m	9
45EC - 221	1,429 Kg/m	3	45EC - 272	2,235 Kg/m	11
45EC - 222	3,579 Kg/m	4	CPU - 401	1,220 Kg/m	24
45EC - 223	0,953 Kg/m	13	CPU - 402	1,508 Kg/m	23
45EC - 225	0,215 Kg/m	6	CPU - 403	1,279 Kg/m	23
45EC - 226	0,281 Kg/m	5	CPU - 404	1,242 Kg/m	24
45EC - 228	0,404 Kg/m	6	CPU - 405	0,963 Kg/m	24
45EC - 229	0,513 Kg/m	14	DS - 238	0,521 Kg/m	25
45EC - 231	1,386 Kg/m	7	ECBG - 213	0,278 Kg/m	25
45EC - 232	0,331 Kg/m	8	ECBG - 214	0,274 Kg/m	22
45EC - 233	0,833 Kg/m	11	ECBG - 215	0,261 Kg/m	22
45EC - 234	1,439 Kg/m	8	ECBG - 216	0,234 Kg/m	22
45EC - 235	1,942 Kg/m	10	ECBG - 217	0,227 Kg/m	22
45EC - 236	1,942 Kg/m	10	ECBG - 218	0,185 Kg/m	22
45EC - 237	0,524 Kg/m	12	MN - 015	0,881 Kg/m	25
45EC - 238	0,211 Kg/m	12	MN - 055	0,371 Kg/m	25
45EC - 239	1,000 Kg/m	14	PR - 003	0,171 Kg/m	5
45EC - 240	2,466 Kg/m	4	SPI - 104	0,687 Kg/m	25
45EC - 247	1,011 Kg/m	15	U - 491	0,093 Kg/m	17

**45EC - 201**

Contramarco  
0,511 Kg/m

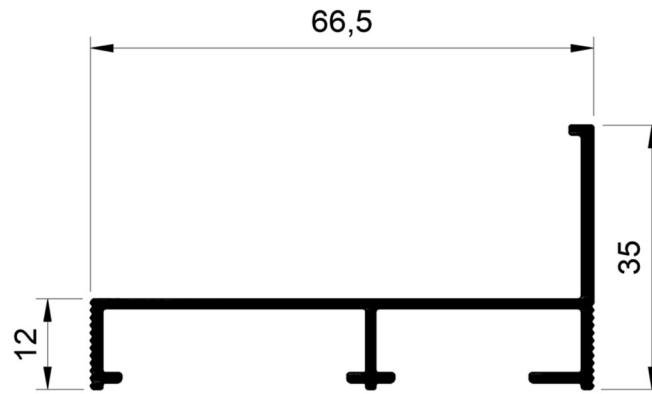

**45EC - 205**

Presilha do Arremate  
0,151 Kg/m

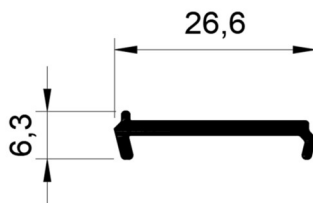

**45EC - 204**

Arremate  
0,225 Kg/m

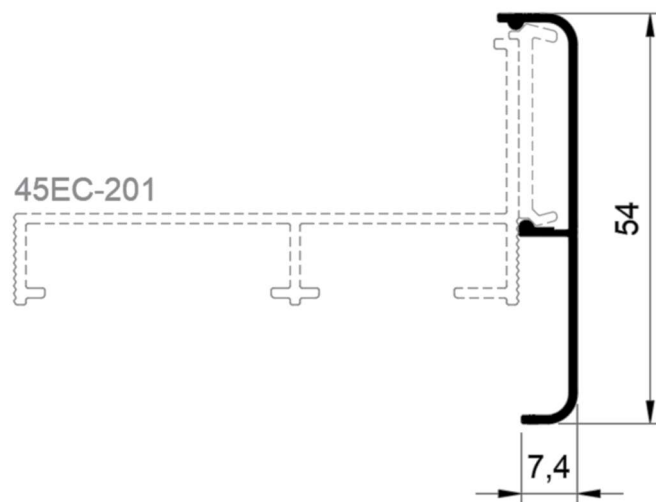

**45EC - 200**

Contramarco Bi-partido  
0,532 Kg/m

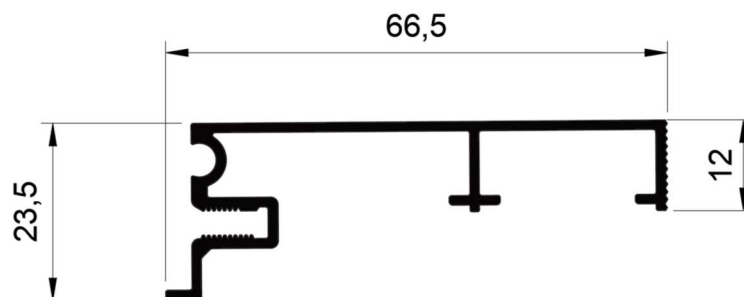

**45EC - 219**

Marco Horizontal Inferior  
02 planos  
2,306 Kg/m

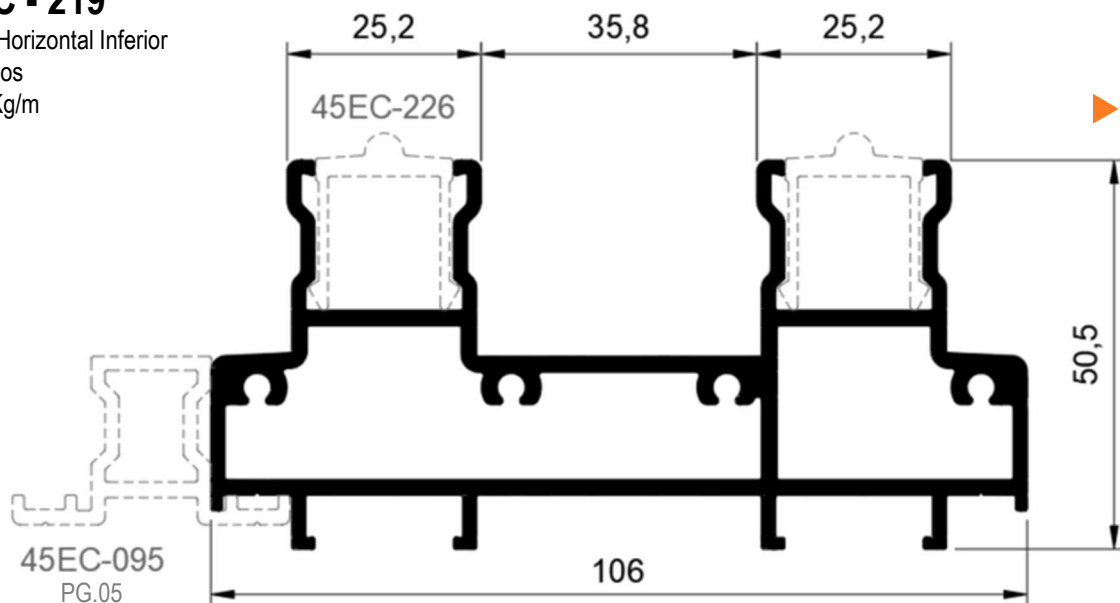

**45EC - 221**

Marco Vertical 02 planos  
1,429 Kg/m

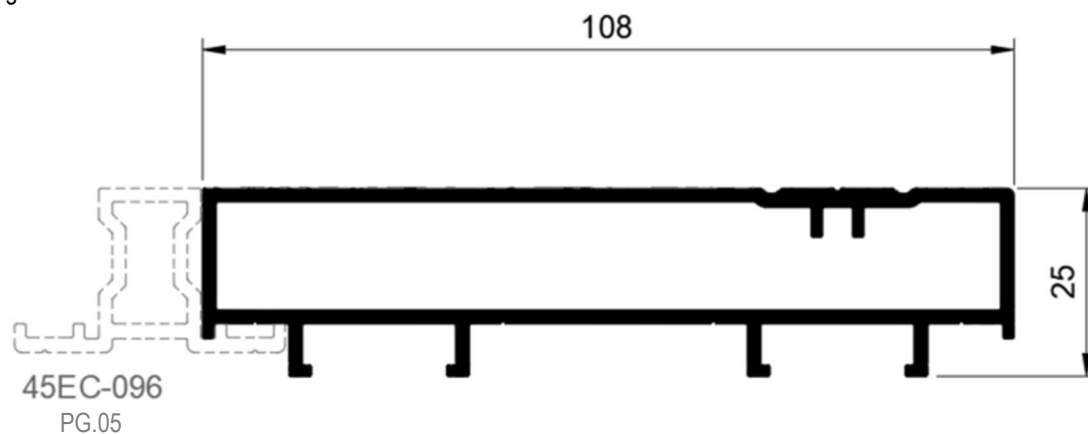

Jx= 3,665 cm <sup>4</sup>	Wx= 2,486 cm <sup>3</sup>
Jy= 62,206 cm <sup>4</sup>	Wy= 11,238 cm <sup>3</sup>

**45EC - 263**

Marco Intermediário  
para peitoril e bandeira  
1,151 Kg/m

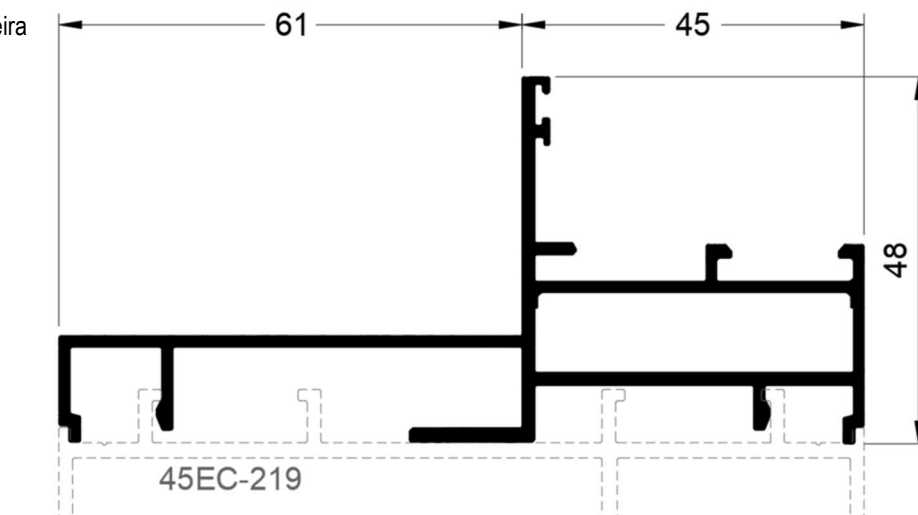

**45EC - 222**

Marco Horizontal Inferior 03 planos  
3,579 Kg/m

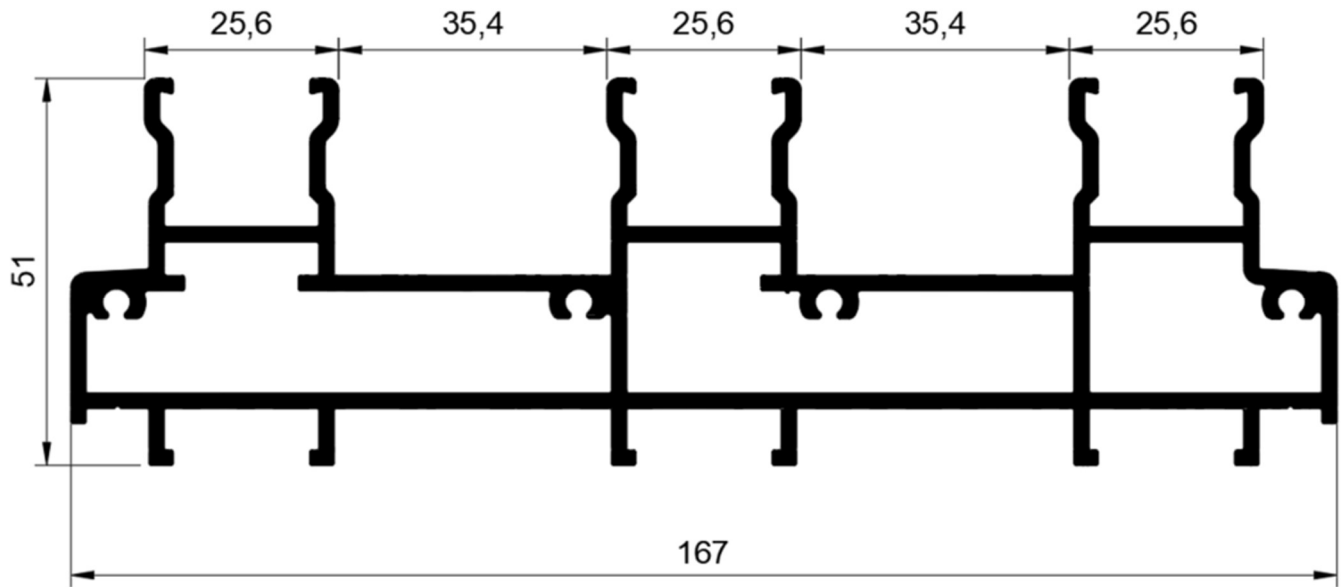
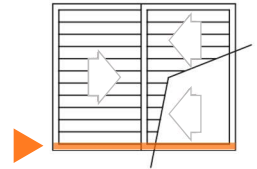

**45EC - 240**

Marco Vertical Lateral 03 planos  
2,466 Kg/m

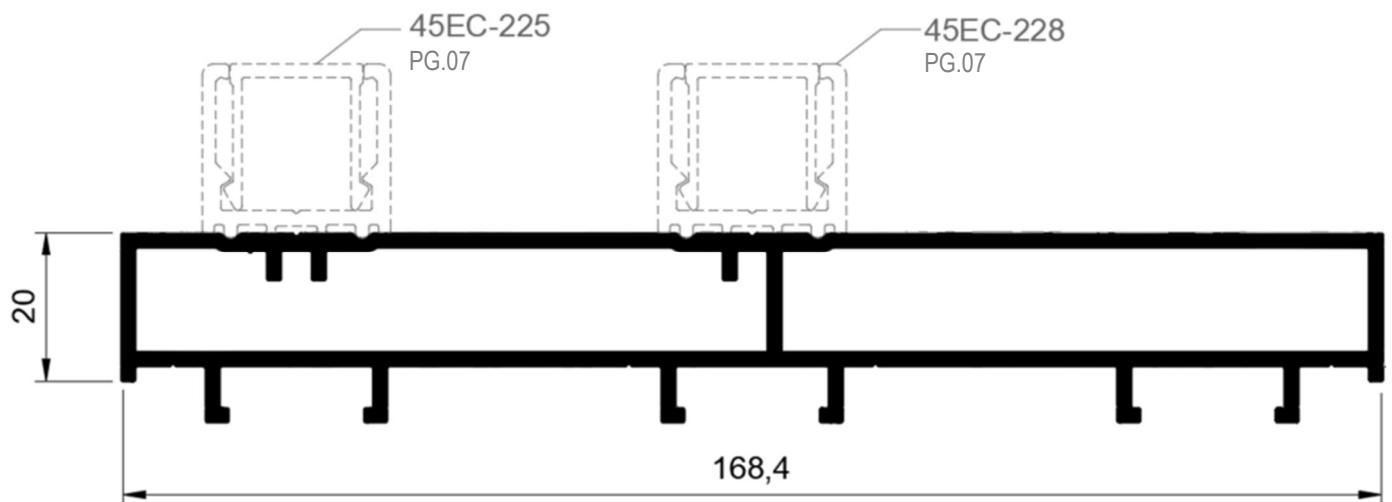
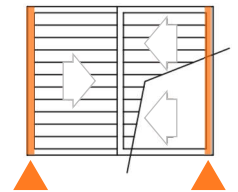

$Jx= 6,330 \text{ cm}^4$	$Wx= 4,183 \text{ cm}^3$
$Jy= 241,096 \text{ cm}^4$	$Wy= 28,031 \text{ cm}^3$

**45EC - 095**

Complemento dos Marcos Horizontais  
(Trilhos)  
0,488 Kg/m

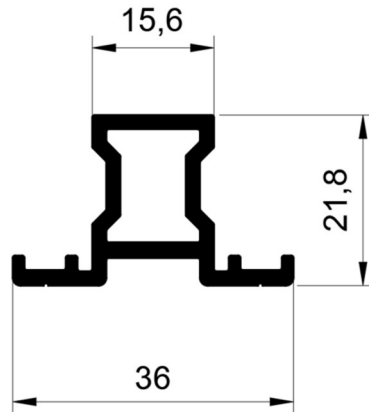
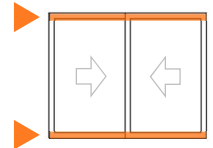

Configuração de planos "infinitos"  
a partir de 02 planos, exemplos:

- 45EC-219 x 45EC-222
- 45EC-240 x 45EC-240
- 45EC-221 x 45EC-240

**45EC - 096**

Complemento dos Marcos Verticais  
(Laterais)  
0,478 Kg/m

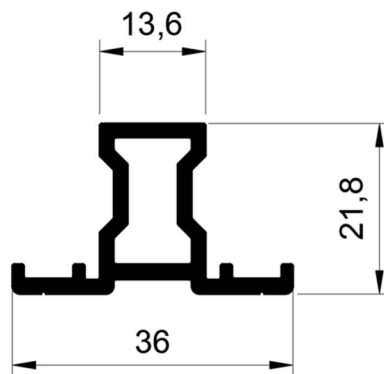
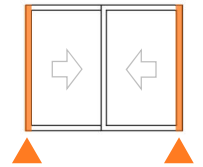

Configuração de planos "infinitos"  
a partir de 02 planos, exemplos:

- 45EC-221 x 45EC-221
- 45EC-240 x 45EC-240
- 45EC-221 x 45EC-240

**45EC - 226**

Capa do Trilho  
0,281 Kg/m

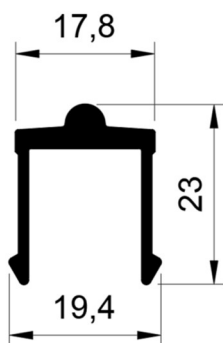
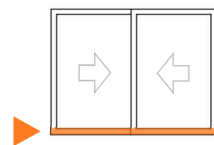

**PR-003**

Trilho "Macarrão"  
0,171 Kg/m

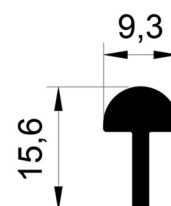
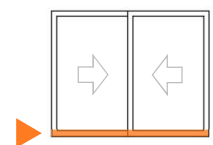



**45EC - 225**

Tampa do Mata Junta  
0,215 Kg/m

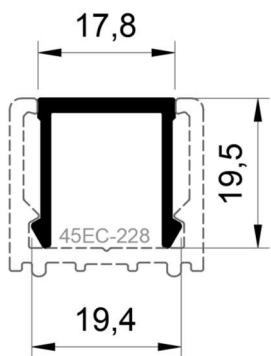
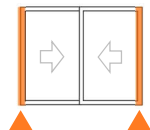

**45EC - 208**

Arremate do Marco  
0,206 Kg/m

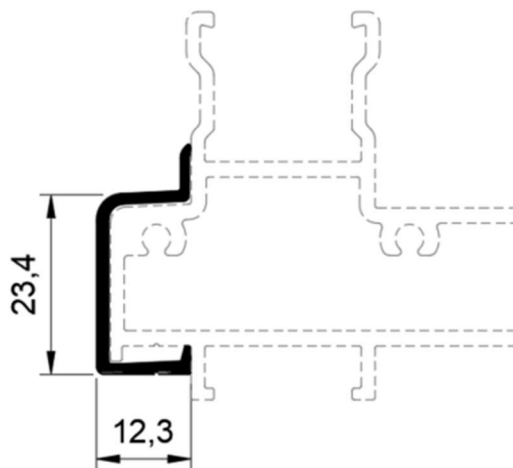
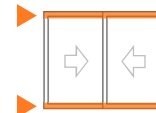

OBS: Usar perfil quando o trilho for partido ao meio

**45EC - 228**

Mata Junta Lateral  
0,404 Kg/m

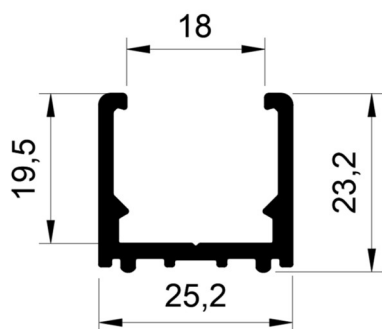
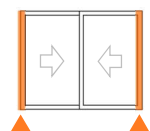

**45EC - 212**

Arremate do Marco  
0,274 Kg/m

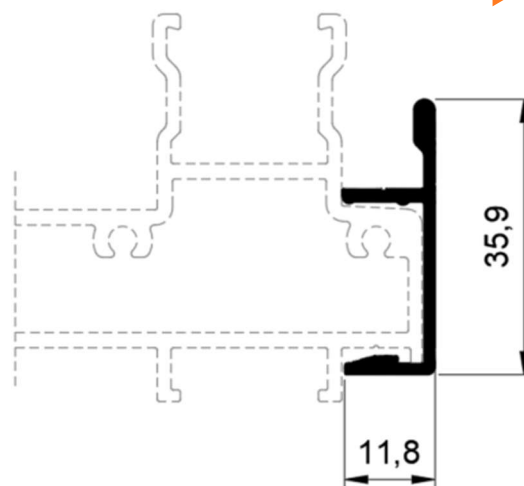
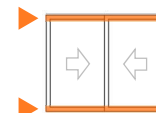

OBS: Usar perfil quando o trilho for partido ao meio

**45EC - 209**

Pingadeira  
0,345 Kg/m

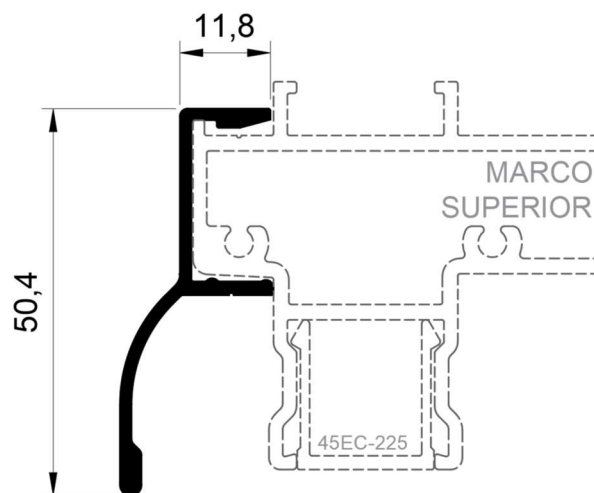
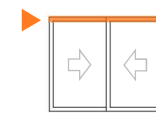

**45EC - 100**

Adaptador de Trilhos  
0,693 Kg/m

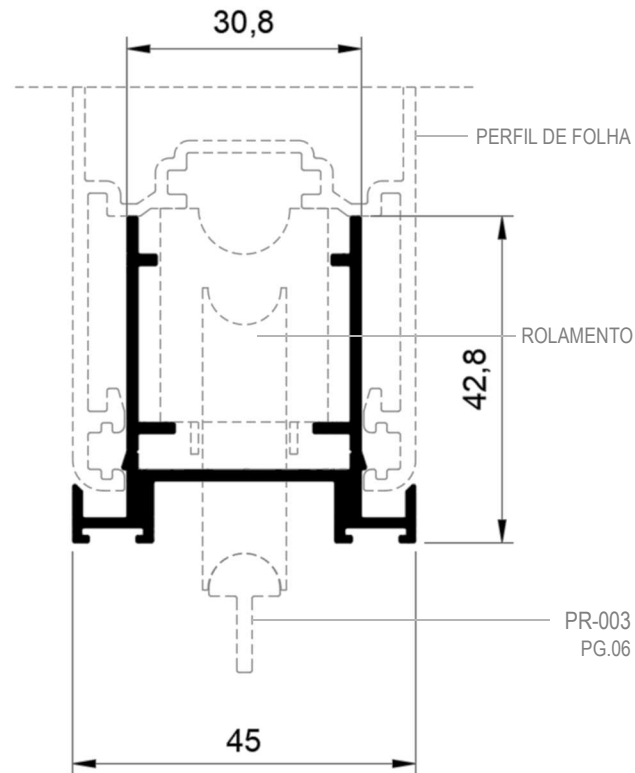
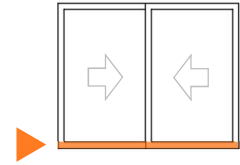

**45EC - 231**

Folha Perimetral  
1,383 Kg/m

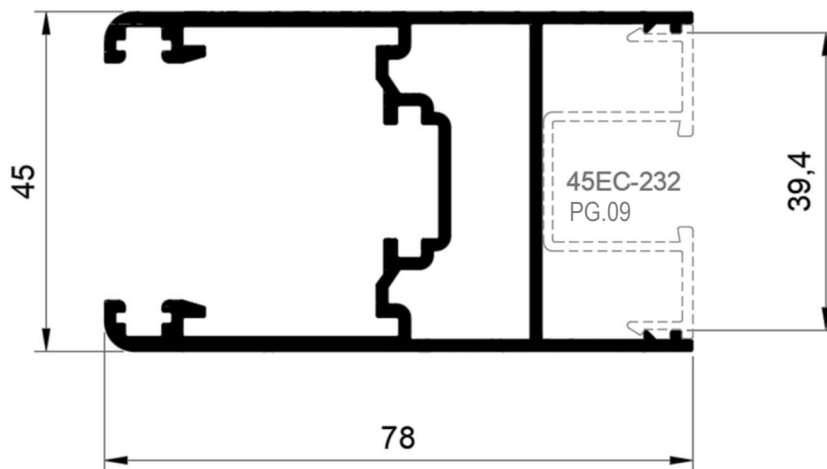
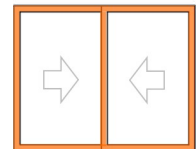

Jx= 17,380 cm <sup>4</sup>	Wx= 7,724 cm <sup>3</sup>
Jy= 22,351 cm <sup>4</sup>	Wy= 5,569 cm <sup>3</sup>

**45EC - 232**

Porta Vidro  
0,331 Kg/m

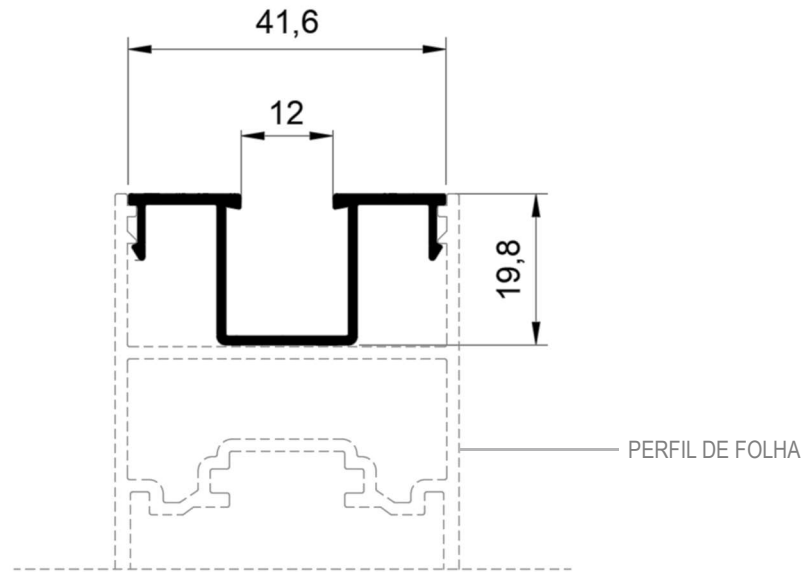
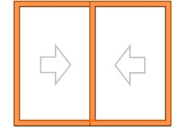

OBS: Usar com vidros de 4 a 8 milímetros

**45EC - 234**

Folha Perimetral  
1,439 Kg/m

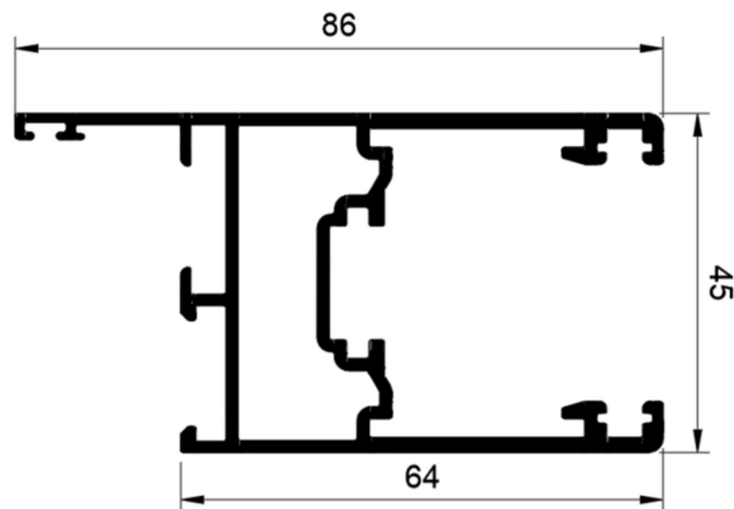
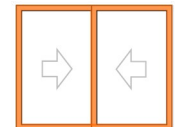

Jx= 17,262 cm <sup>4</sup>	Wx= 7,162 cm <sup>3</sup>
Jy= 24,806 cm <sup>4</sup>	Wy= 5,200 cm <sup>3</sup>

**45EC - 270**

Folha Perimetral  
1,737 Kg/m

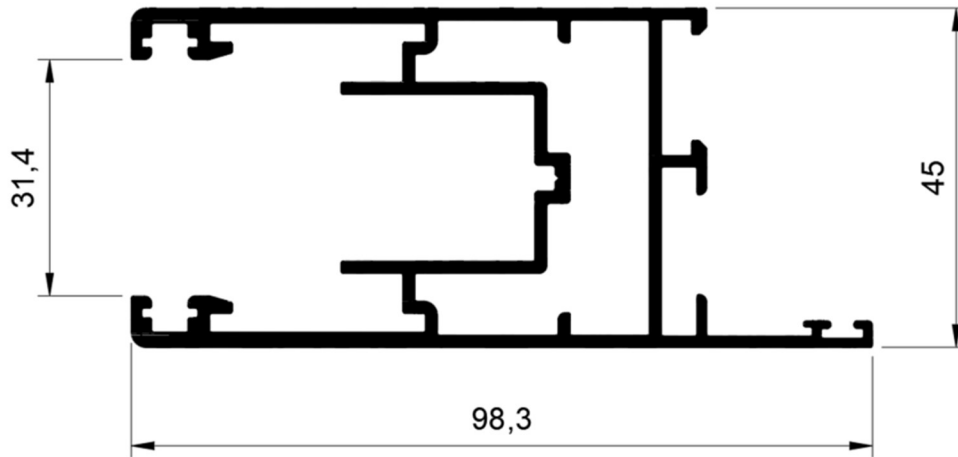
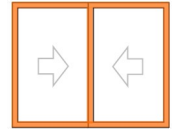

Jx= 20,347 cm <sup>4</sup>	Wx= 8,513 cm <sup>3</sup>
Jy= 38,998 cm <sup>4</sup>	Wy= 7,221 cm <sup>3</sup>

**45EC - 271**

Folha com Câmara Europeia com Reforço  
2,235 Kg/m

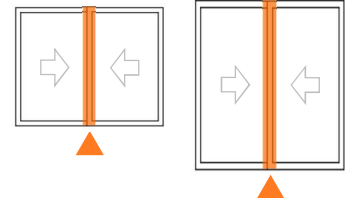

**SOB ENCOMENDA**

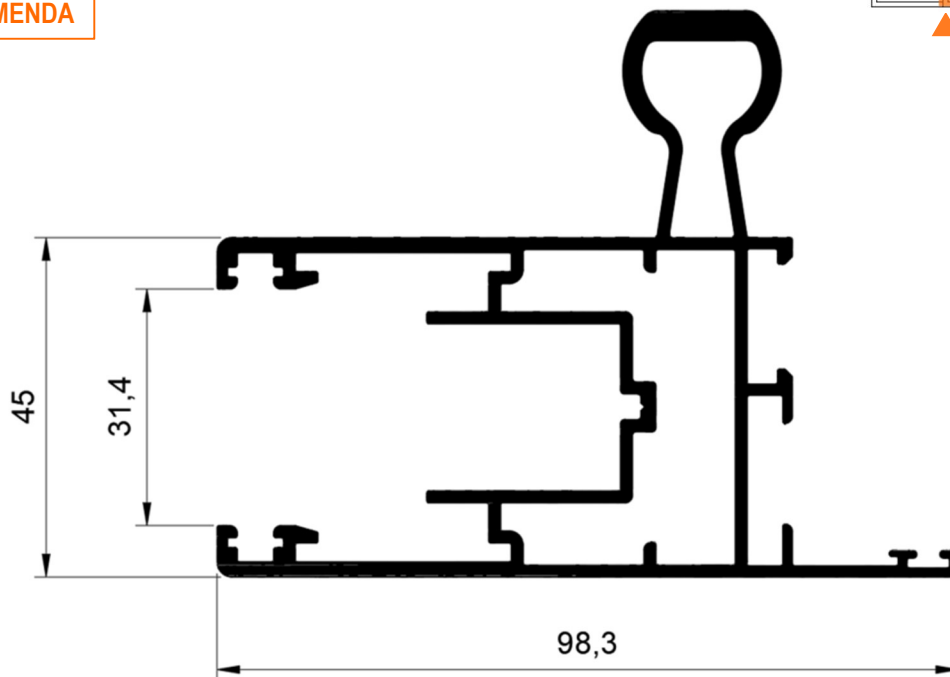

Jx= 48,542 cm <sup>4</sup>	Wx= 10,984 cm <sup>3</sup>
Jy= 45,406 cm <sup>4</sup>	Wy= 9,173 cm <sup>3</sup>

**45EC - 235**

Folha com reforço  
1,942 Kg/m

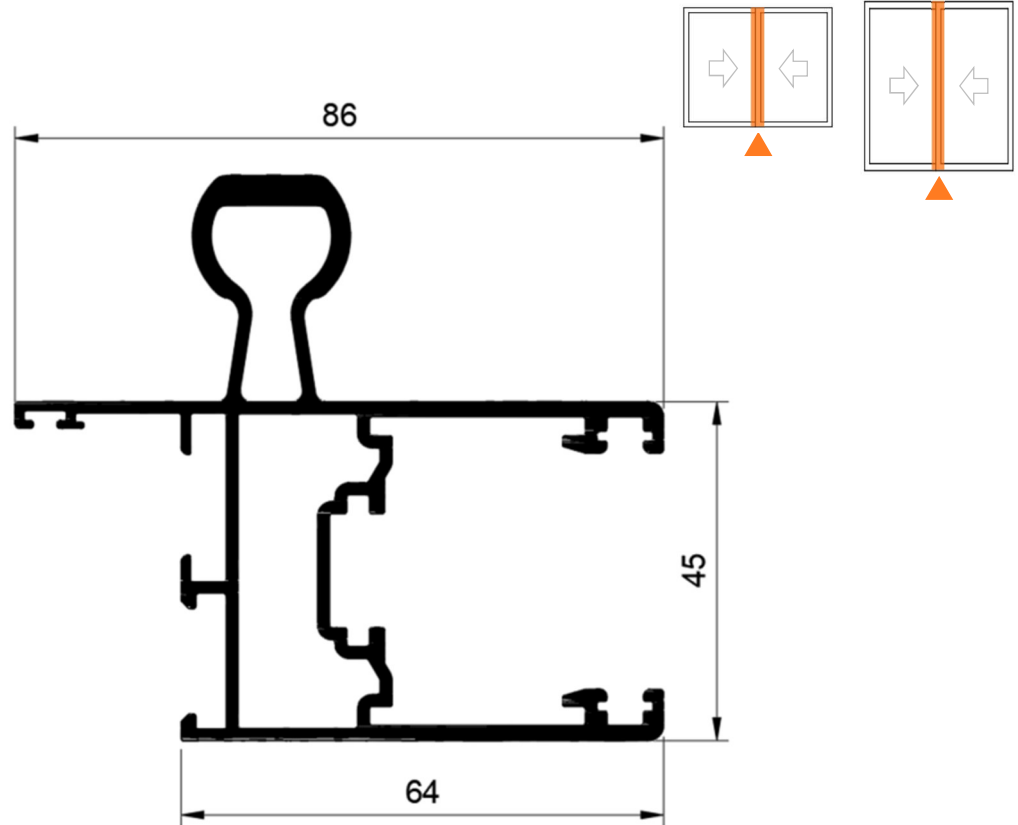

$J_x = 40,871 \text{ cm}^4$	$W_x = 10,091 \text{ cm}^3$
$J_y = 28,090 \text{ cm}^4$	$W_y = 6,369 \text{ cm}^3$

**45EC - 236**

Folha com reforço  
1,942 Kg/m

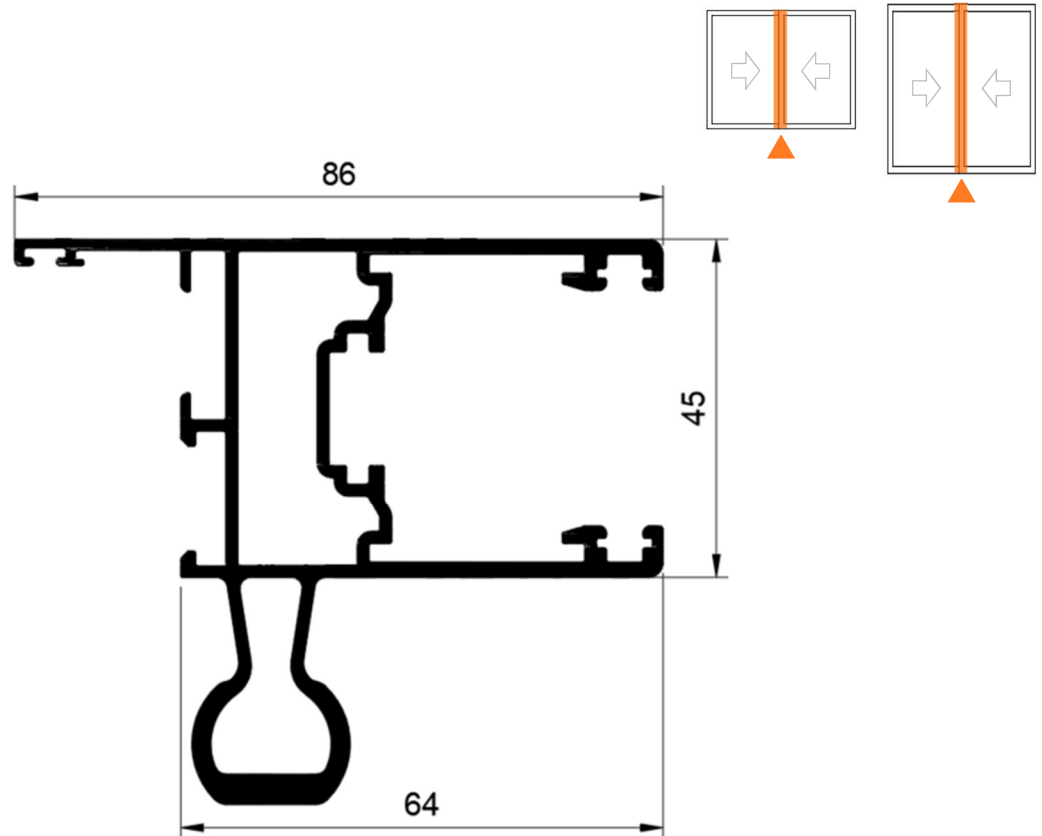

$J_x = 44,580 \text{ cm}^4$	$W_x = 13,602 \text{ cm}^3$
$J_y = 28,090 \text{ cm}^4$	$W_y = 6,396 \text{ cm}^3$

**45EC - 272**

Folha com Câmara Europeia com Reforço  
2,235 Kg/m

**SOB ENCOMENDA**

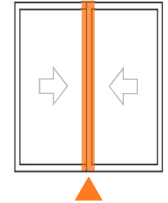
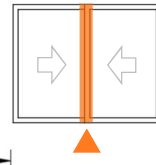
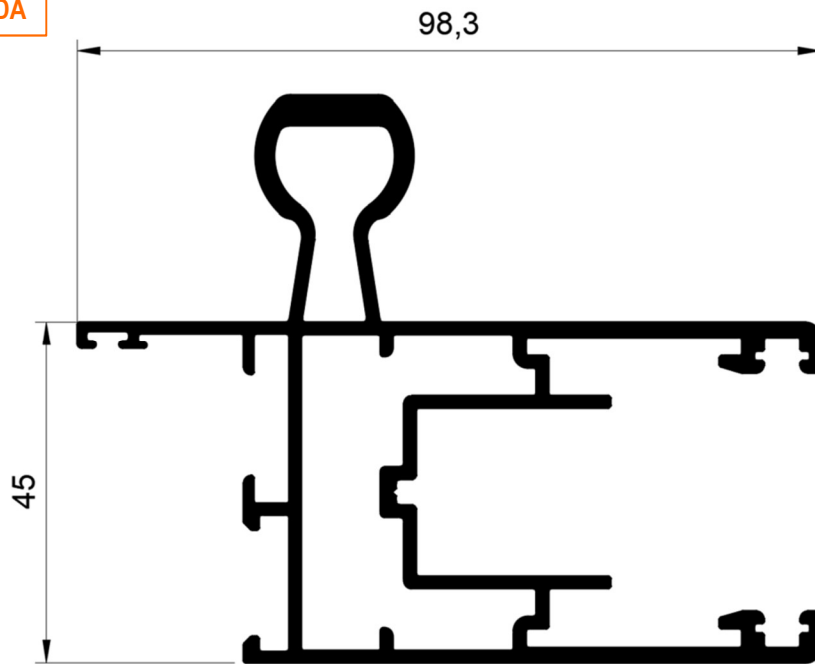

Jx= 45,287 cm <sup>4</sup>	Wx= 10,759 cm <sup>3</sup>
Jy= 45,406 cm <sup>4</sup>	Wy= 9,173 cm <sup>3</sup>

**45EC - 233**

Mão de Amigo  
0,833 Kg/m

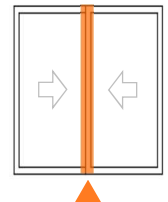
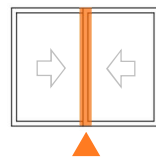
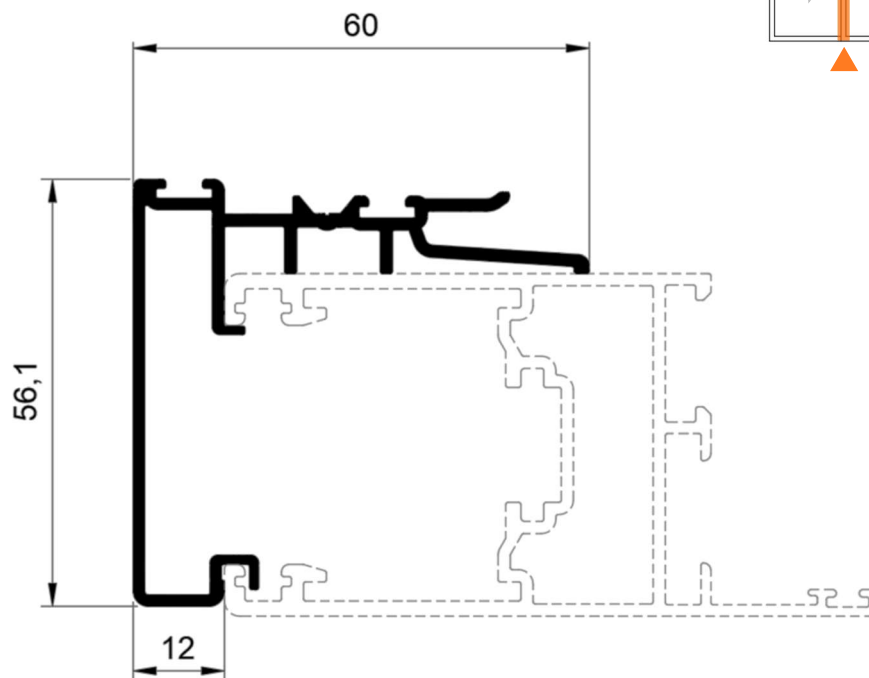

Jx= 9,613 cm <sup>4</sup>	Wx= 2,503 cm <sup>3</sup>
Jy= 9,308 cm <sup>4</sup>	Wy= 2,248 cm <sup>3</sup>

### 45EC - 237

Mão de Amigo  
0,524 Kg/m

OBS: Usar somente nos perfis  
45EC-231, 45EC-234, 45EC-235 e 45EC-236

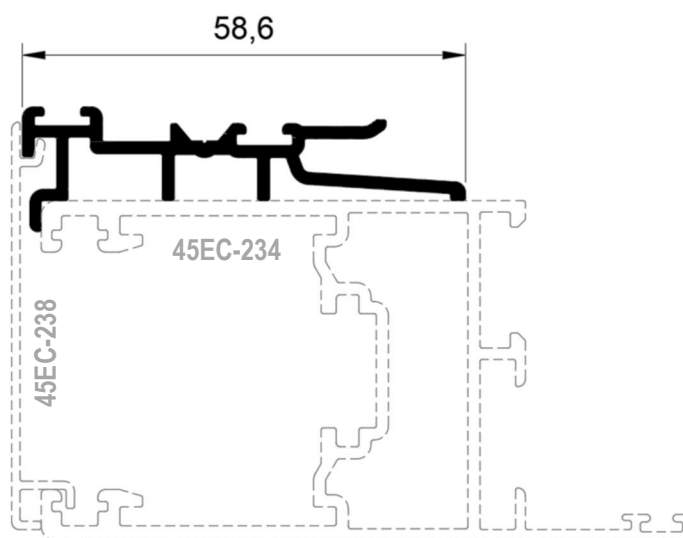
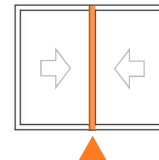

$J_x = 0,221 \text{ cm}^4$	$W_x = 0,233 \text{ cm}^3$
$J_y = 5,494 \text{ cm}^4$	$W_y = 1,650 \text{ cm}^3$

### 45EC - 133

Mão de Amigo  
0,648 Kg/m

OBS: Usar somente nos perfis  
45EC-270, 45EC-271 e 45EC-272

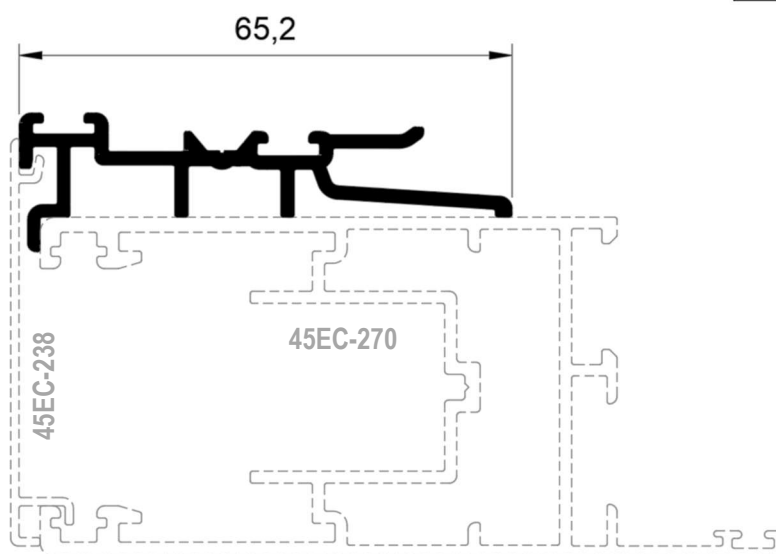
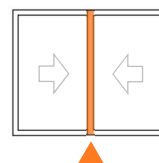

$J_x = 0,339 \text{ cm}^4$	$W_x = 0,308 \text{ cm}^3$
$J_y = 8,420 \text{ cm}^4$	$W_y = 2,275 \text{ cm}^3$

### 45EC - 238

Complemento da Mão de Amigo  
0,211 Kg/m

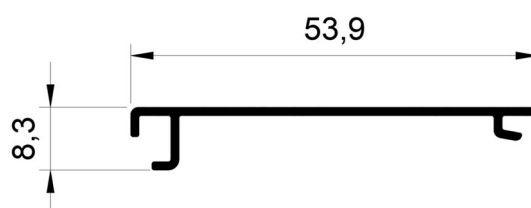
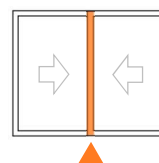

**45EC - 091**

Montante Central com Reforço SLIM  
2,169 Kg/m

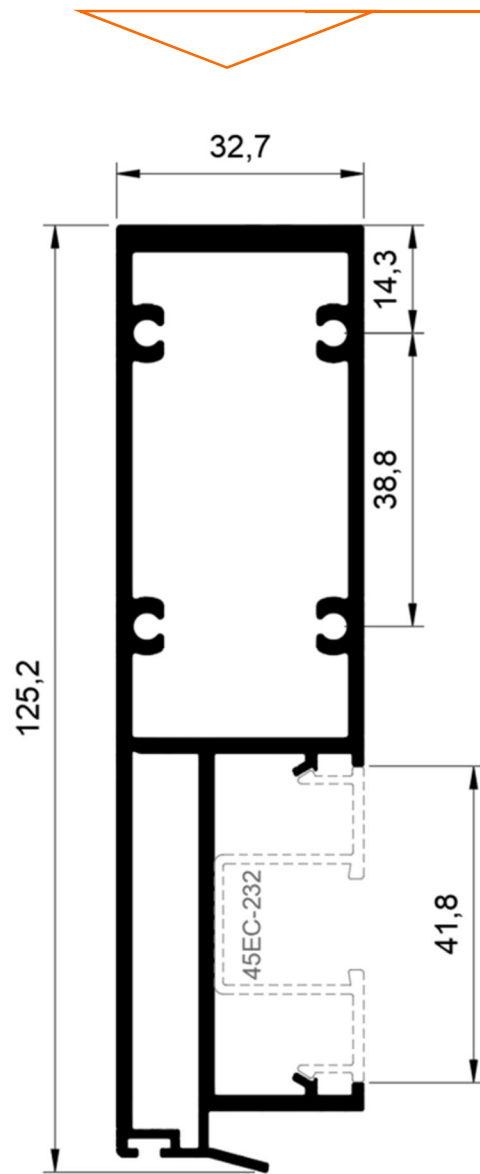

Perfis com vista frontal de **32 mm**

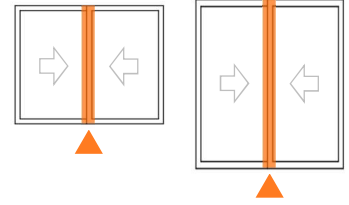

$Jx= 126,557 \text{ cm}^4$	$Wx= 18,456 \text{ cm}^3$
$Jy= 11,801 \text{ cm}^4$	$Wy= 6,341 \text{ cm}^3$

**45EC - 223**

Montante Central SLIM  
0,953 Kg/m

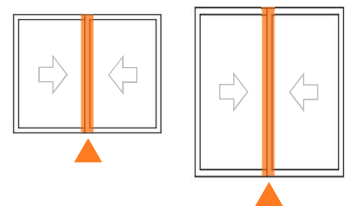
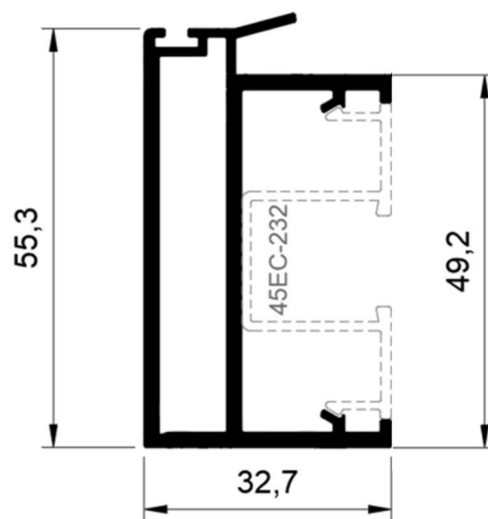

$Jx= 13,459 \text{ cm}^4$	$Wx= 4,427 \text{ cm}^3$
$Jy= 3,006 \text{ cm}^4$	$Wy= 1,398 \text{ cm}^3$



### 45EC - 229

Mata Junta Central  
0,513 Kg/m

OBS: Aplicável aos perfis  
45EC-231, 45EC-234, 45EC-235, 45EC-236, 45EC-270, 45EC-271 e 45EC-272

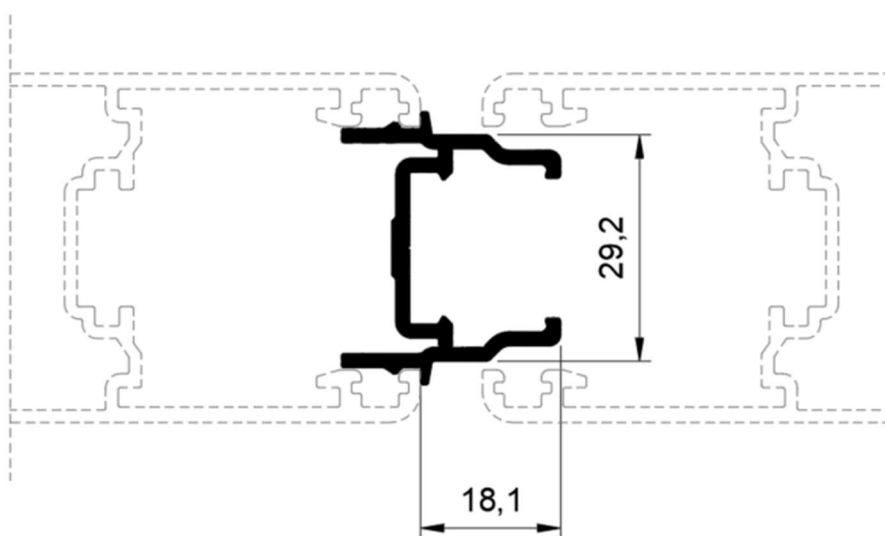
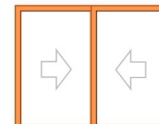

$J_x = 2,647 \text{ cm}^4$	$W_x = 1,504 \text{ cm}^3$
$J_y = 0,961 \text{ cm}^4$	$W_y = 0,616 \text{ cm}^3$

### 45EC - 239

Reforço da Folha  
1,000 Kg/m

OBS: Aplicável aos perfis  
45EC-231, 45EC-234, 45EC-235 e 45EC-236

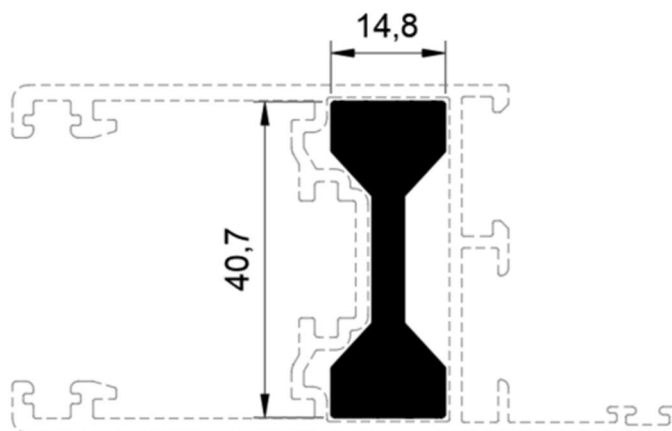
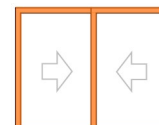

$J_x = 7,345 \text{ cm}^4$	$W_x = 3,600 \text{ cm}^3$
$J_y = 0,465 \text{ cm}^4$	$W_y = 0,629 \text{ cm}^3$

**45EC - 268**

Marco  
0,846 Kg/m

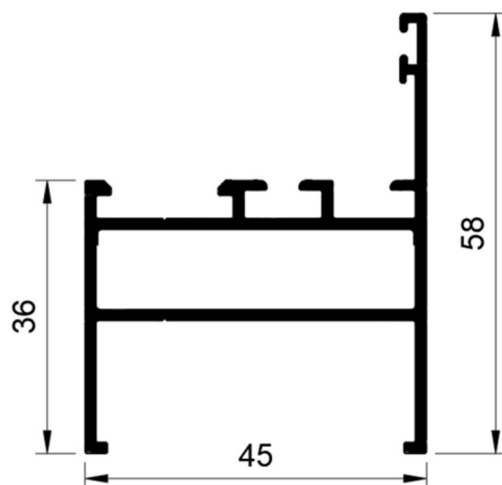
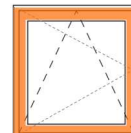

**45EC - 247**

Folha Maxim-ar  
1,011 Kg/m

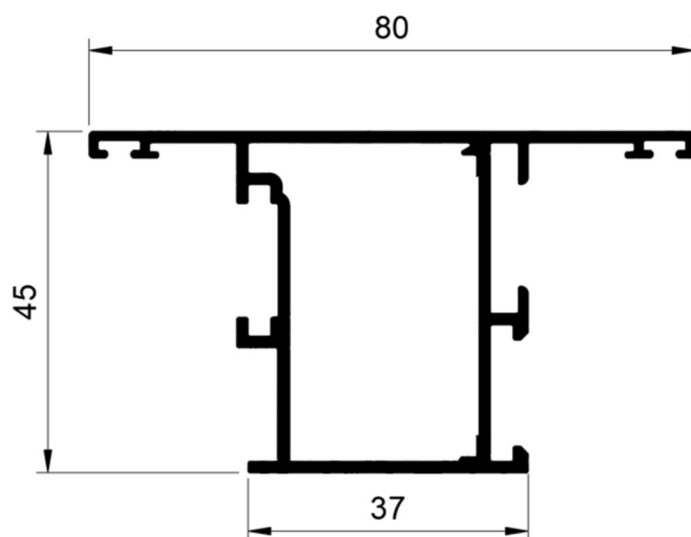
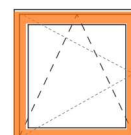

**45EC - 267**

Folha Oscilobatente  
1,010 Kg/m

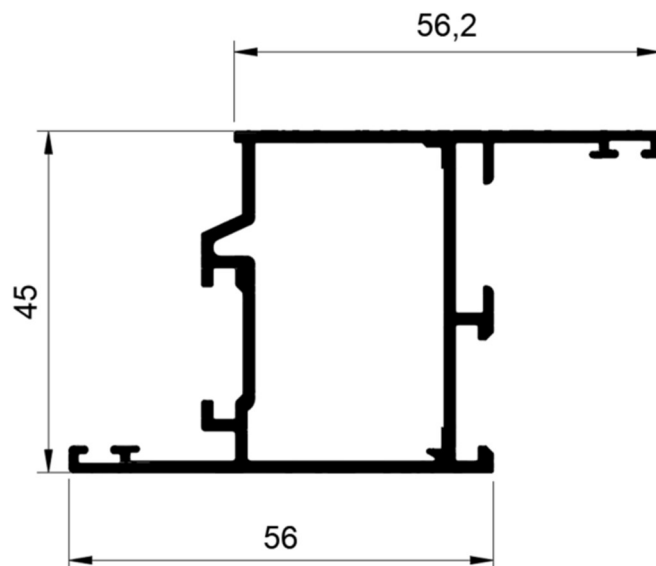
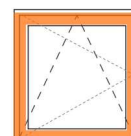

**45EC - 269**

Coluna / Travessa Maxim-ar e Oscilobatente  
1,117 Kg/m

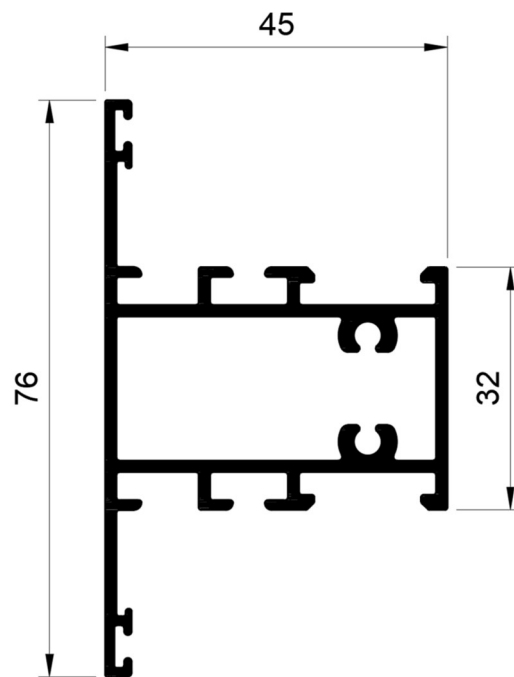
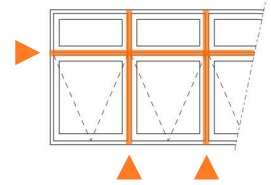

**45EC - 258**

Inversor de Baguete  
0,574 Kg/m

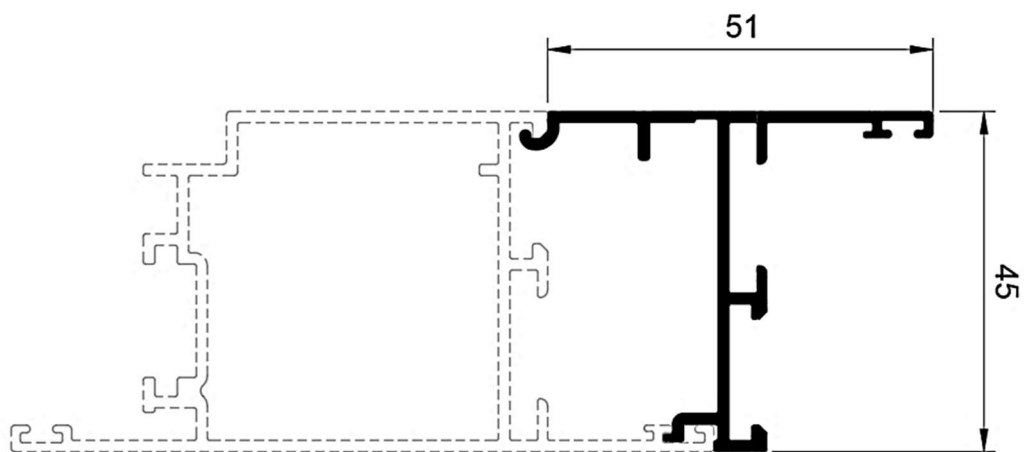
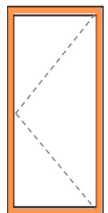

**45EC - 254**

Travessa e Folhas Maxim-ar  
1,076 Kg/m

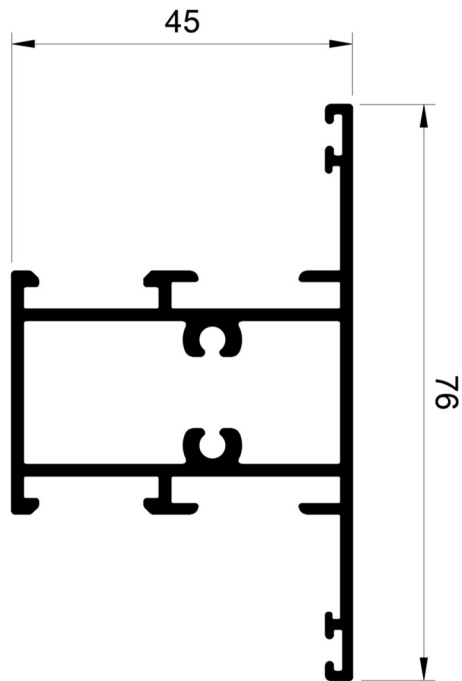
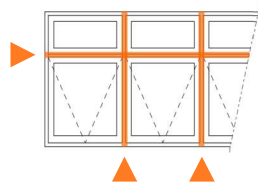

**45EC - 255**

Inversor Maxim-ar  
0,657 Kg/m

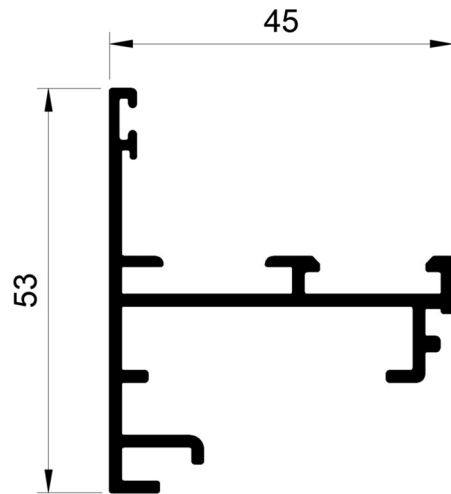
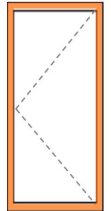

**45EC - 210**

Pingadeira Maxim-ar  
0,288 Kg/m

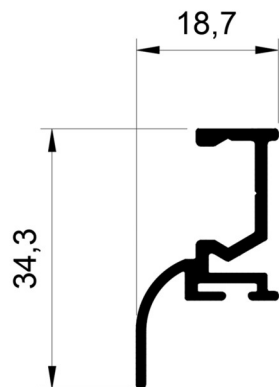
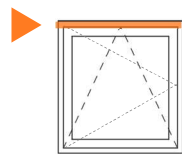

**U - 491**

Tampa da Pingadeira Maxim-ar  
0,093 Kg/m

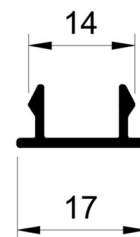
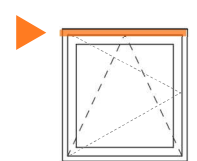

**45EC - 251**

Folha da Porta de giro  
1,140 Kg/m

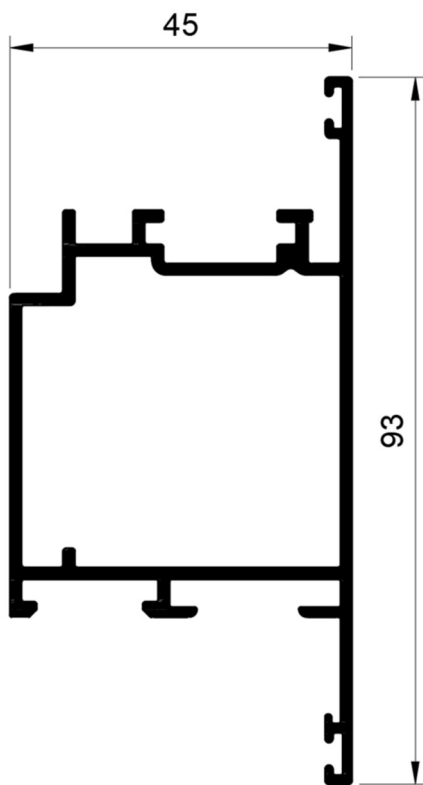
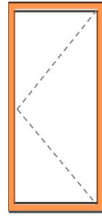

$J_x = 12,424 \text{ cm}^4$	$W_x = 4,620 \text{ cm}^3$
$J_y = 22,902 \text{ cm}^4$	$W_y = 4,802 \text{ cm}^3$

**45EC - 252**

Folha da Porta de giro  
0,511 Kg/m

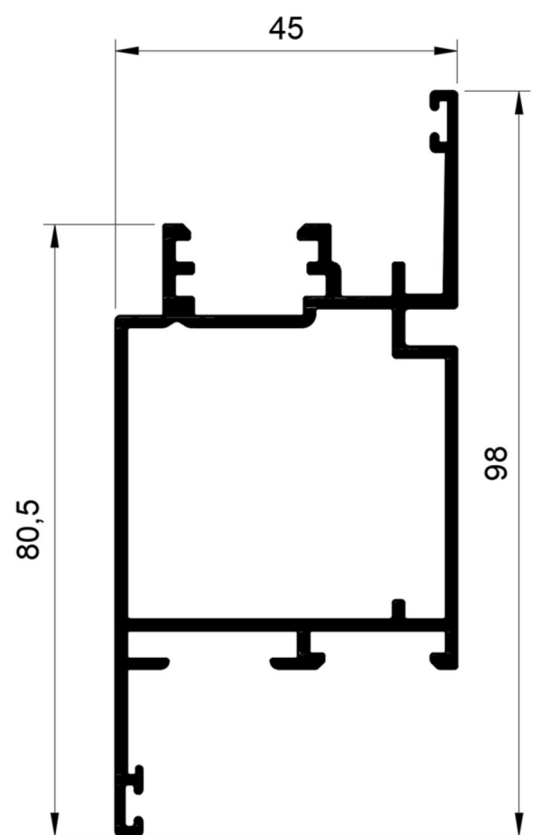
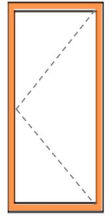

$J_x = 14,181 \text{ cm}^4$	$W_x = 6,149 \text{ cm}^3$
$J_y = 27,386 \text{ cm}^4$	$W_y = 5,402 \text{ cm}^3$

**45EC - 249**

Marco Perimetral Porta de Giro  
0,785 Kg/m

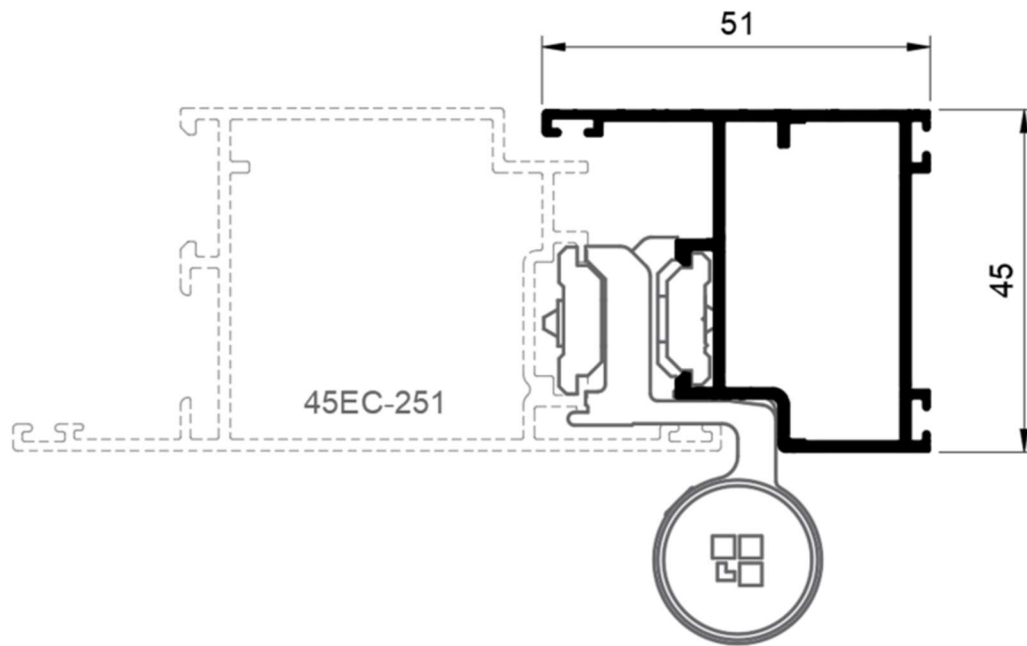
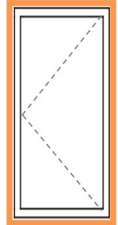

**45EC - 248**

Marco Perimetral Porta de Giro  
1,099 Kg/m

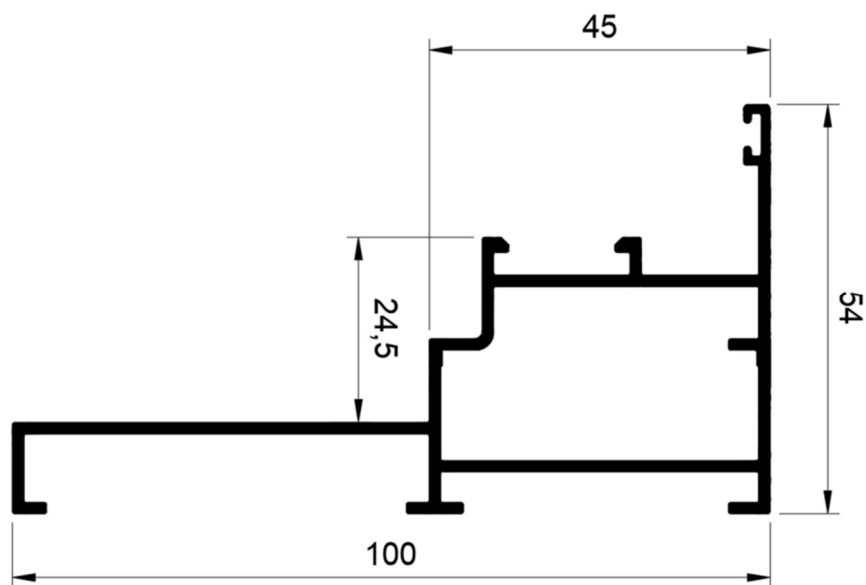
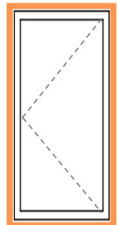

**45EC - 250**

Travessa para Porta de Giro  
1,545 Kg/m

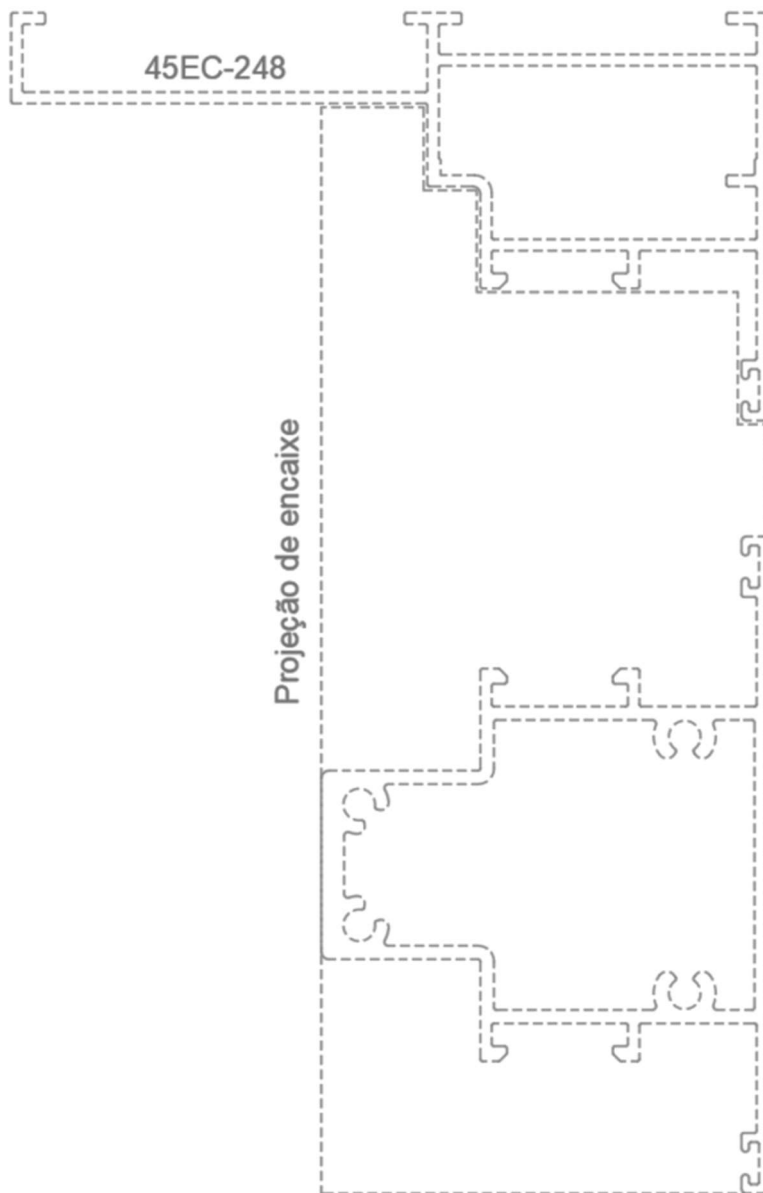
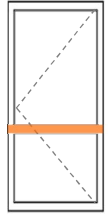
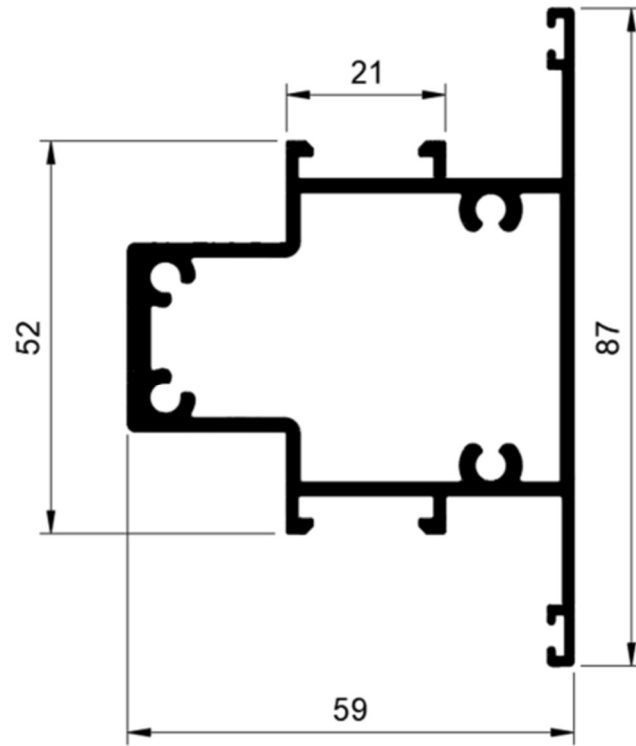

**45EC - 253**

Largura Inferior da Porta de Giro  
2,247 Kg/m

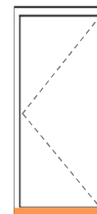
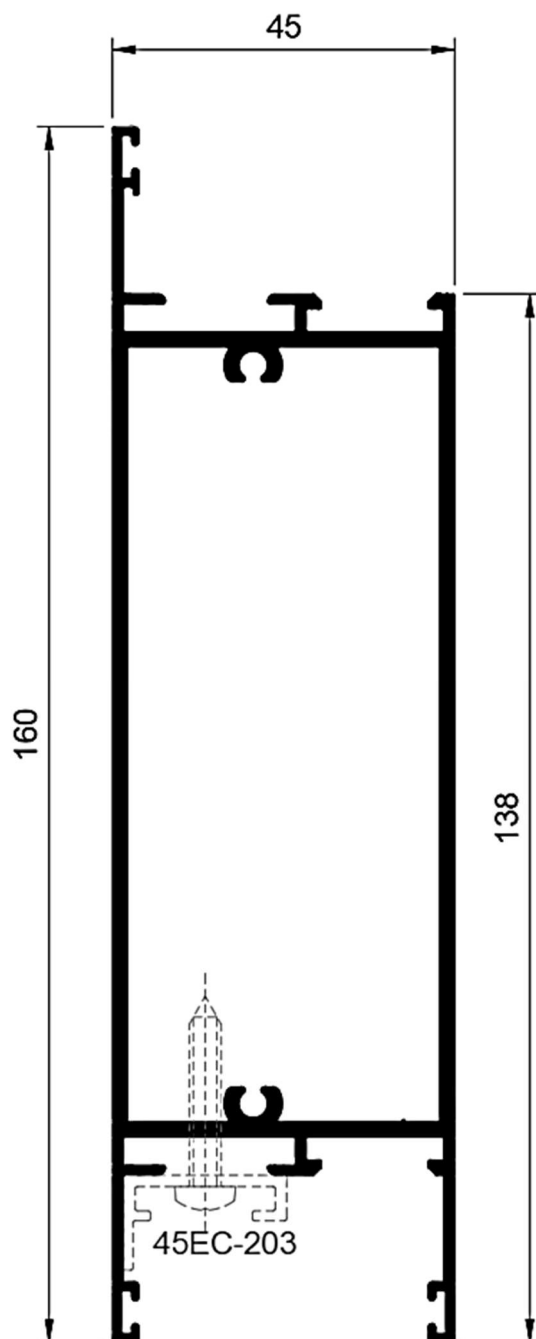

**45EC - 203**

Complemento Largura Inferior da Porta de Giro  
0,162 Kg/m

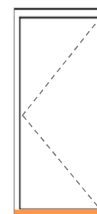
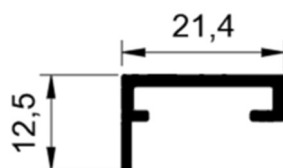



**ECBG - 213**

Baguete  
0,278 Kg/m

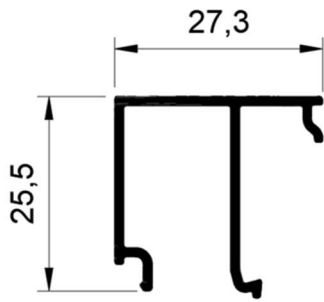
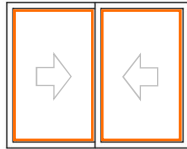

**ECBG - 214**

Baguete  
0,274 Kg/m

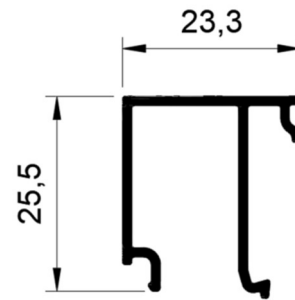
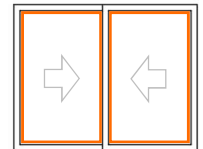

**ECBG - 215**

Baguete  
0,261 Kg/m

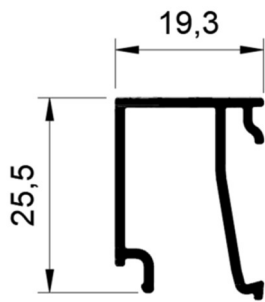
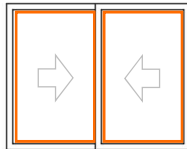

**ECBG - 216**

Baguete  
0,234 Kg/m

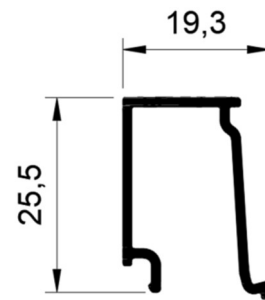
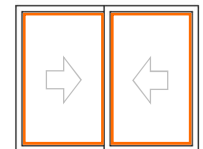

**ECBG - 217**

Baguete  
0,227 Kg/m

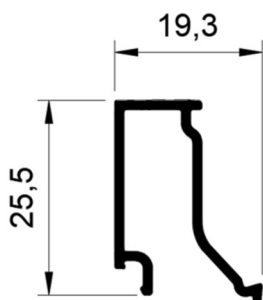
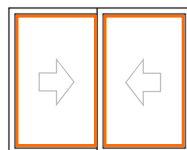

**ECBG - 218**

Baguete  
0,185 Kg/m

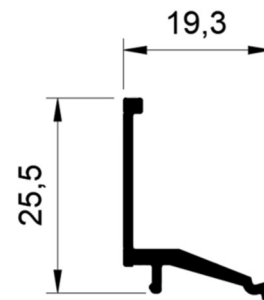
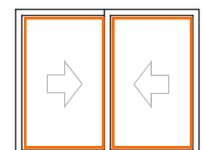

**CPU - 402**

Marco Superior da Integrada  
1,508 Kg/m

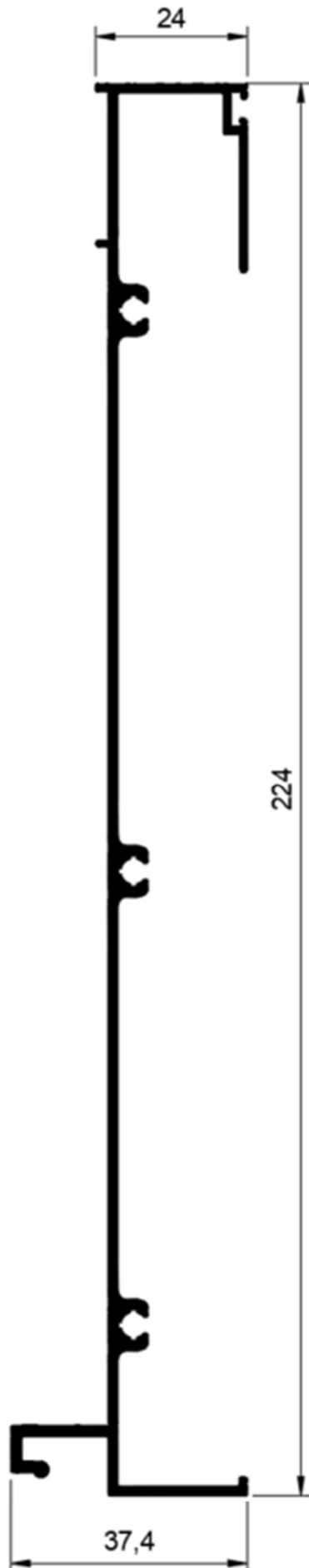
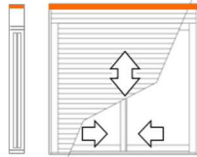

**CPU - 403**

Tampa Externa da Integrada  
1,280 Kg/m

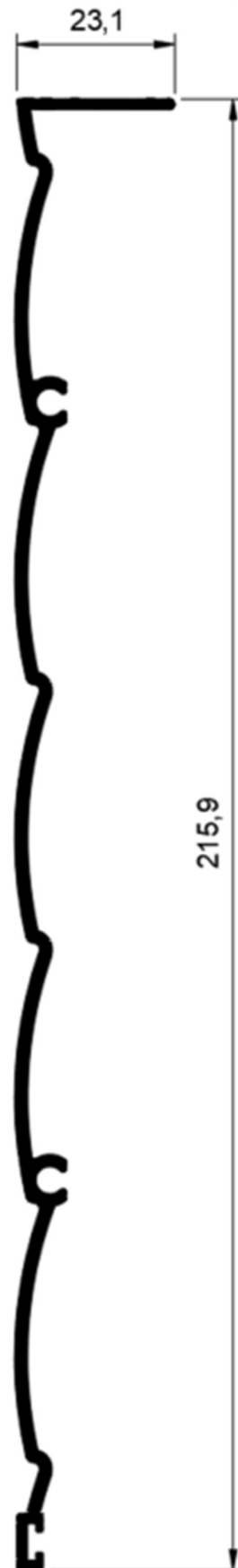
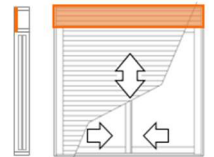

**CPU - 401**

Marco Lateral da Integrada  
1,220 Kg/m

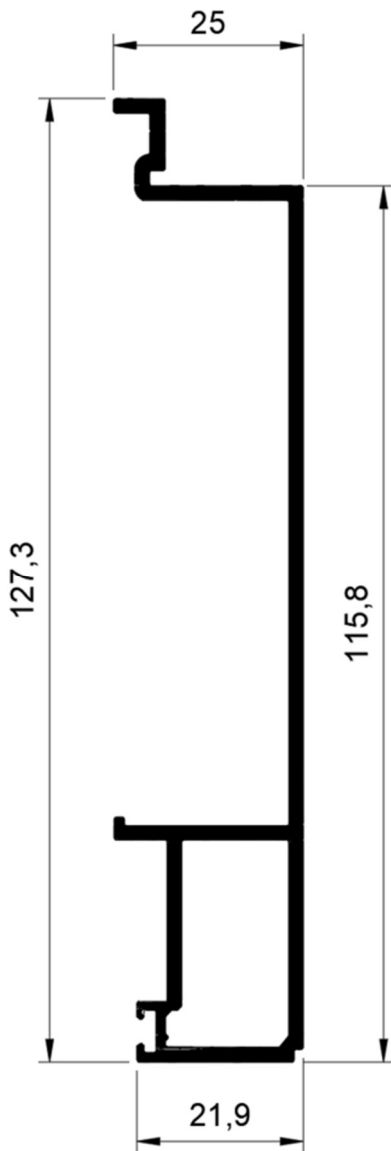
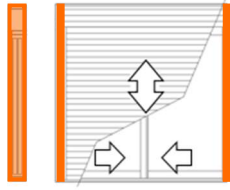

**CPU - 404**

Tampa Interna da Integrada  
1,665 Kg/m

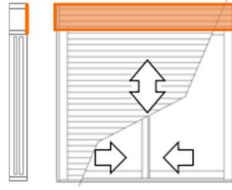

**CPU - 405**

Marco Intermediário da Integrada  
0,963 Kg/m

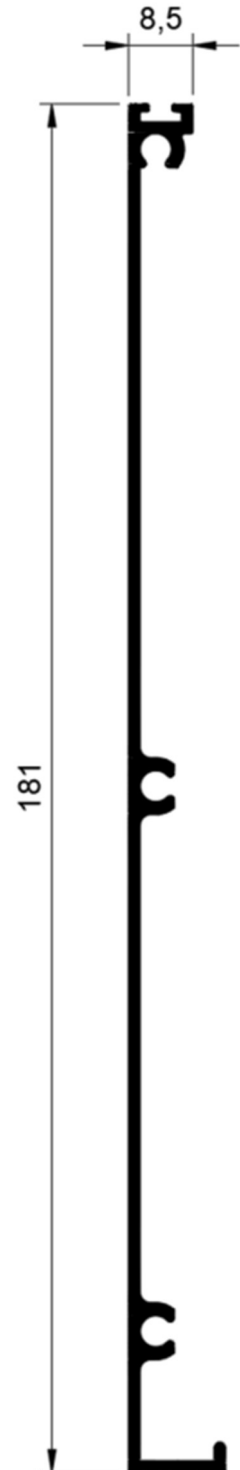
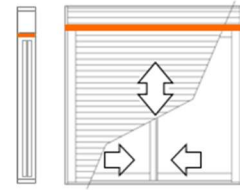

**SPI - I04**

Guia Lateral  
0,687 Kg/m

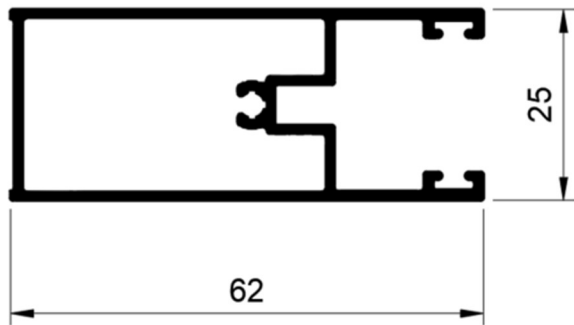
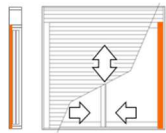

**DS - 238**

Tubo da Persiana  
0,521 Kg/m

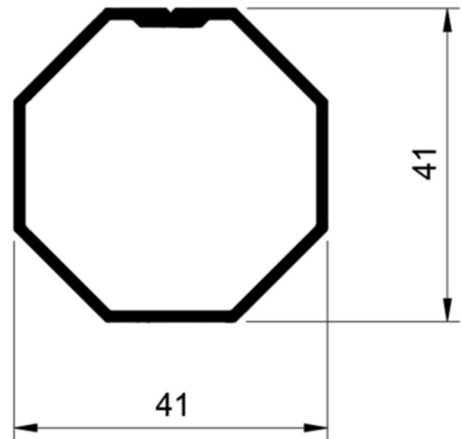
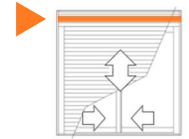

**MN - 055**

Terminal da Persiana  
0,371 Kg/m

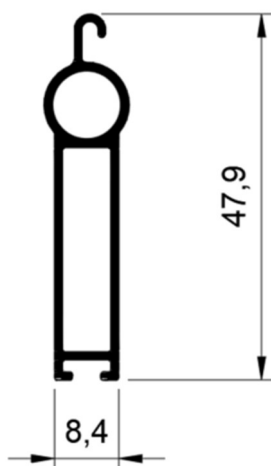





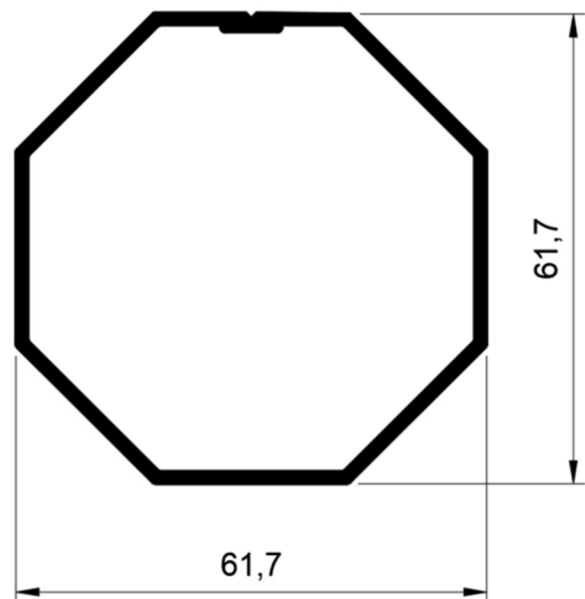



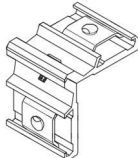

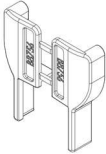
**MN - 015**



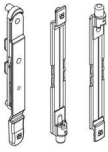
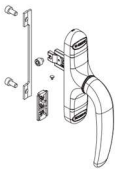
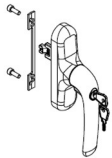

Tubo da Persiana  
0,881 Kg/m

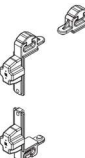
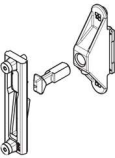
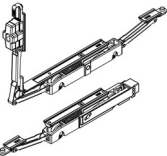

ACESSÓRIO	CÓDIGO	CÓDIGO UNIVERSAL	DESCRIÇÃO
	<b>COS-03524</b>	BARR10000	Vareta de Poliamida
	<b>COS-02979</b>	BATD10013	Batedeira
	<b>COS-08349</b>	BRAC10008NAT	Braço GS HD – 10
	<b>COS-08350</b>	BRAC10009NAT	Braço GS HD – 16
	<b>COS-08351</b>	BRAC10010NAT	Braço GS HD – 22
	<b>COS-08352</b>	BRAC10011NAT	Braço GS HD – 28
	<b>COS-08194</b>	BRAC10013INX	Braço GS HD – 24
	<b>COS-01971</b>	CALC10004PTO	Calço para Braço
	<b>COS-07681</b>	CILD10006NAT	Cilindro
	<b>COS-04630</b>	CONT10006NAT	Contra Fecho
	<b>81.39025.135</b>	81.39025.135	Conexão Anudal

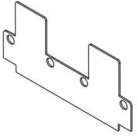
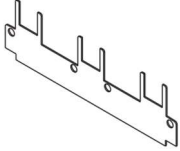
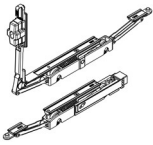
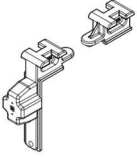
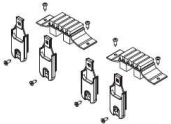
ACESSÓRIO	CÓDIGO	CÓDIGO UNIVERSAL	DESCRIÇÃO
	<b>COS-00340</b>	CONX10012NAT	Conexão Kamel
	<b>COS-00348</b>	CONX10013NAT	Conexão Folha
	<b>COS-00349</b>	CONX10014NAT	Conexão Kamel
	<b>COS-00350</b>	CONX10015NAT	Conexão de Canto para a Folha
	<b>COS-02921</b>	CONX10016NAT	Conexão de Alinhamento
	<b>COS-00357</b>	CONX10038NAT	Conexão Kamel
	<b>COS-00681</b>	DOBR10006	Dobradiça Flash
	<b>COS-02938</b>	DREN10000	Par de Tampas para Pingadeira
	<b>COS-07058N</b>	ESPL00951	Roseta
	<b>COS-04627</b>	FDRA10011NAT	Fechadura
	<b>COS-01164N</b>	FECH01098	Cremona Única

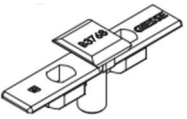
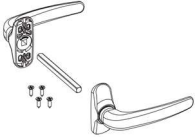
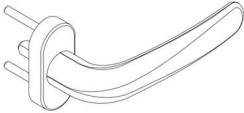
ACESSÓRIO	CÓDIGO	CÓDIGO UNIVERSAL	DESCRIÇÃO
	<b>COS-02191N</b>	FECH01090NAT	Fecho unha 2° Folha
	<b>COS-01039</b>	FECH01089	Cremona Prima s/ chave
	<b>COS-01091</b>	FECH01089	Cremona Prima c/ chave
	<b>GUA-410</b>	GUAR00410PTO	Guarnição Folha e Marco
	<b>GUA-412</b>	GUAR00412PTO	Guarnição Vidro
	<b>GUA-413</b>	GUAR00413PTO	Guarnição Vidro
	<b>COS-02970</b>	GUAR10035PTO	Gaxeta
	<b>COS-02933</b>	KTTP10012	Kit de Adaptadores para Batedeira
	<b>COS-02929</b>	KTFC10000NAT	Kit para Fechamento GOS-S
	<b>ROL-03913</b>	KTRD10000NAT	Kit Roldana de 90 a 200 Kg

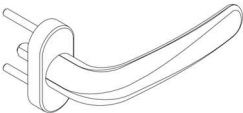
ACESSÓRIO	CÓDIGO	CÓDIGO UNIVERSAL	DESCRIÇÃO
	<b>COS-02974</b>	VEDA10017NAT	Espuma selante para trilhos planos
	<b>COS-02975</b>	VEDA10018NAT	Espuma selante para trilhos planos
	<b>ROL-03916</b>	KTRD10001NAT	Kit Roldana até 90 Kg
	<b>COS-02939</b>	KTTP10001NAT	Kit de Adaptadores para Batedeira
	<b>COS-02945</b>	COS-02945	Kit de Adaptadores GOS-S
	<b>COS-04099</b>	KTTR00625NAT	Dispositivo de Ligação
			Vareta-Cremona
	<b>COS-02792</b>	MACN10000	Maçaneta Prima Plus
	<b>COS-02908</b>	MACN10010	Cremona Martelina Longo
	<b>COS-02942</b>	MACN10011	Fecho de Embutir para Janelas
	<b>COS-02948</b>	MACN10012	Cremona Martelina Curto



ACESSÓRIO	CÓDIGO	CÓDIGO UNIVERSAL	DESCRIÇÃO
	<b>COS-06745</b>	NYLO00485PTO	Calço para Vidro de 5 mm
	<b>COS-06746</b>	NYLO00486PTO	Calço para Vidro de 2 mm
	<b>COS-00645</b>	SUPT10009NAT	Placa para perfil inversor
	<b>COS-02947</b>	TAMP10033PTO	Adaptadores para duas folhas
	<b>COS-04027K</b>	TRAV00015FCO	Botão para pontos de fechamento
	<b>COS-02954</b>	TRAV10010NAT	GOS-S Kit para folha fixa
	<b>COS-01353K</b>	TRAV00020NAT	Complemento do fecho
	<b>COS-02951</b>	TRAV10016NAT	Mecanismo da Cremona
	<b>COS-04020K</b>	TRAV10017NAT	Reenvio de ângulo

ECBG - 213

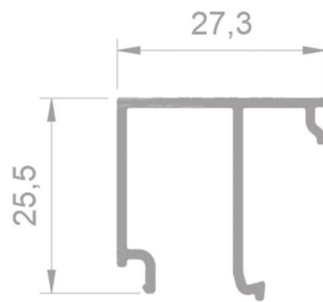

DETALHES		Espessura Vidro (mm)	Guarnição Interna	Guarnição Externa
45EC-247		4	GUA412	GUA414
		5	GUA411	GUA414
		6	GUA412	GUA413
		7	GUA411	GUA413
45EC-234		4	GUA412	GUA414
		5	GUA411	GUA414
		6	GUA412	GUA413
		7	GUA411	GUA413
45EC-251		4	GUA412	GUA414
		5	GUA411	GUA414
		6	GUA412	GUA413
		7	GUA411	GUA413
45EC-268		4	GUA412	GUA414
		5	GUA411	GUA414
		6	GUA412	GUA413
		7	GUA411	GUA413

ECBG - 214

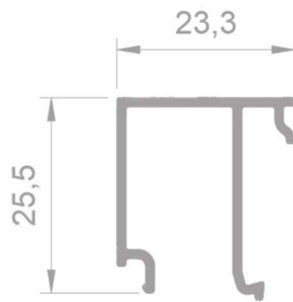

DETALHES		Espessura Vidro (mm)	Guarnição Interna	Guarnição Externa
45EC-247		8	GUA412	GUA414
		9	GUA411	GUA414
		10	GUA412	GUA413
		11	GUA411	GUA413
45EC-234		8	GUA412	GUA414
		9	GUA411	GUA414
		10	GUA412	GUA413
		11	GUA411	GUA413
45EC-251		8	GUA412	GUA414
		9	GUA411	GUA414
		10	GUA412	GUA413
		11	GUA411	GUA413
45EC-268		8	GUA412	GUA414
		9	GUA411	GUA414
		10	GUA412	GUA413
		11	GUA411	GUA413

ECBG - 215

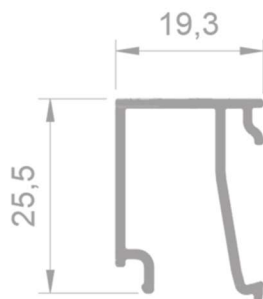

DETALHES		Espessura Vidro (mm)	Guarnição Interna	Guarnição Externa
45EC-247		12	GUA412	GUA414
		13	GUA411	GUA414
		14	GUA412	GUA413
		15	GUA411	GUA413
45EC-234		12	GUA412	GUA414
		13	GUA411	GUA414
		14	GUA412	GUA413
		15	GUA411	GUA413
45EC-251		12	GUA412	GUA414
		13	GUA411	GUA414
		14	GUA412	GUA413
		15	GUA411	GUA413
45EC-268		12	GUA412	GUA414
		13	GUA411	GUA414
		14	GUA412	GUA413
		15	GUA411	GUA413

ECBG - 216

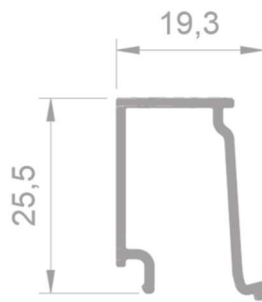

DETALHES		Espessura Vidro (mm)	Guarnição Interna	Guarnição Externa
45EC-247		16	GUA412	GUA414
		17	GUA411	GUA414
		18	GUA412	GUA413
		19	GUA411	GUA413
45EC-234		16	GUA412	GUA414
		17	GUA411	GUA414
		18	GUA412	GUA413
		19	GUA411	GUA413
45EC-251		16	GUA412	GUA414
		17	GUA411	GUA414
		18	GUA412	GUA413
		19	GUA411	GUA413
45EC-268		16	GUA412	GUA414
		17	GUA411	GUA414
		18	GUA412	GUA413
		19	GUA411	GUA413

ECBG - 217

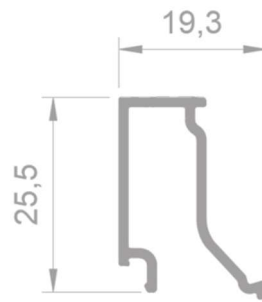

DETALHES		Espessura Vidro (mm)	Guarnição Interna	Guarnição Externa
45EC-247		20	GUA412	GUA414
		21	GUA411	GUA414
		22	GUA412	GUA413
		23	GUA411	GUA413
45EC-234		20	GUA412	GUA414
		21	GUA411	GUA414
		22	GUA412	GUA413
		23	GUA411	GUA413
45EC-251		20	GUA412	GUA414
		21	GUA411	GUA414
		22	GUA412	GUA413
		23	GUA411	GUA413
45EC-268		20	GUA412	GUA414
		21	GUA411	GUA414
		22	GUA412	GUA413
		23	GUA411	GUA413

ECBG - 218

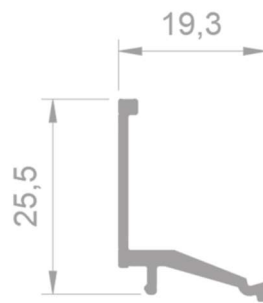

DETALHES		Espessura Vidro (mm)	Guarnição Interna	Guarnição Externa
45EC-247		28	GUA412	GUA414
		30	GUA412	GUA413
		32	GUA411	GUA413
45EC-234		28	GUA412	GUA414
		30	GUA412	GUA413
		32	GUA411	GUA413
45EC-251		28	GUA412	GUA414
		30	GUA412	GUA413
		32	GUA411	GUA413
45EC-268		28	GUA412	GUA414
		30	GUA412	GUA413
		32	GUA411	GUA413

**Janelas** de 02, 03, 04 e 06 folhas de correr

Opcionais: Persiana Integrada, Basculante Superior e/ou Inferior, Venezianas

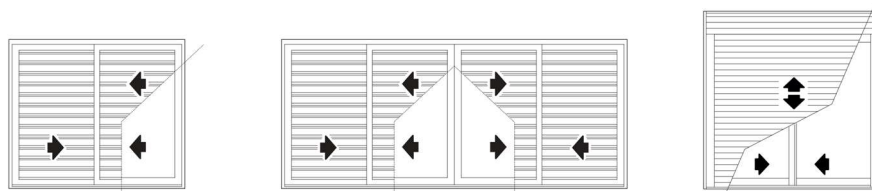
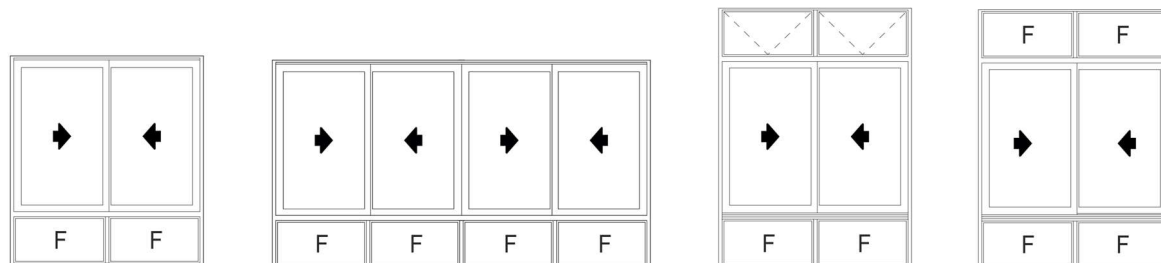
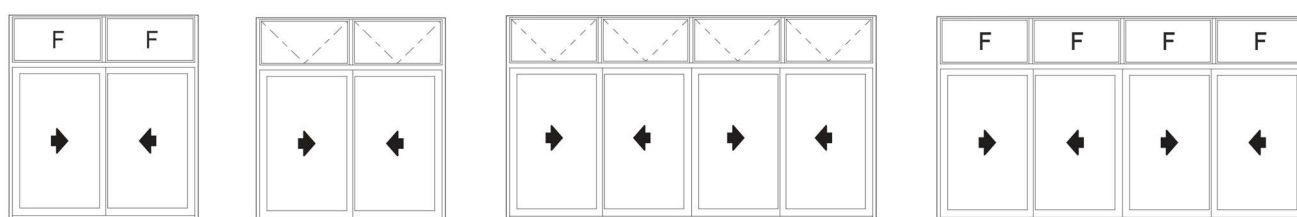
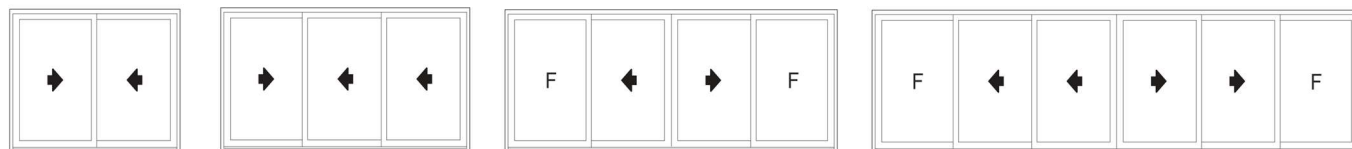



Portas de 02, 03, 04 e 06 folhas de correr

Opcionais: Persiana Integrada, Basculante Superior, Venezianas

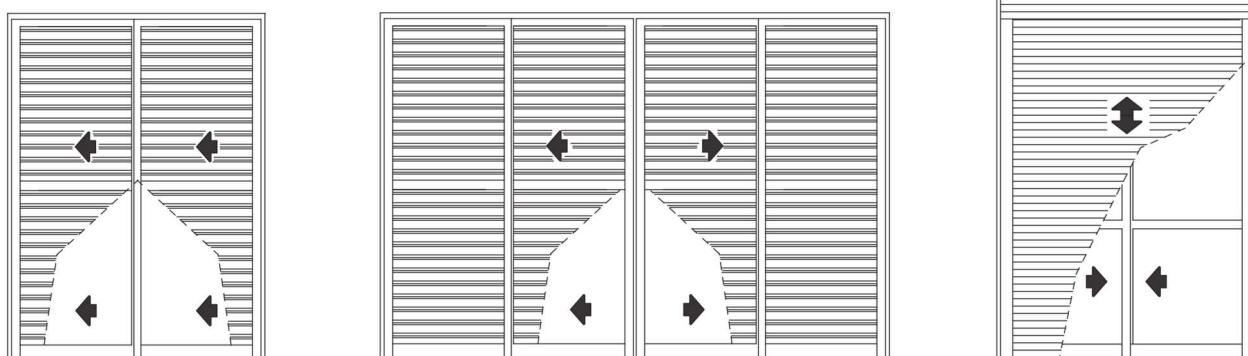
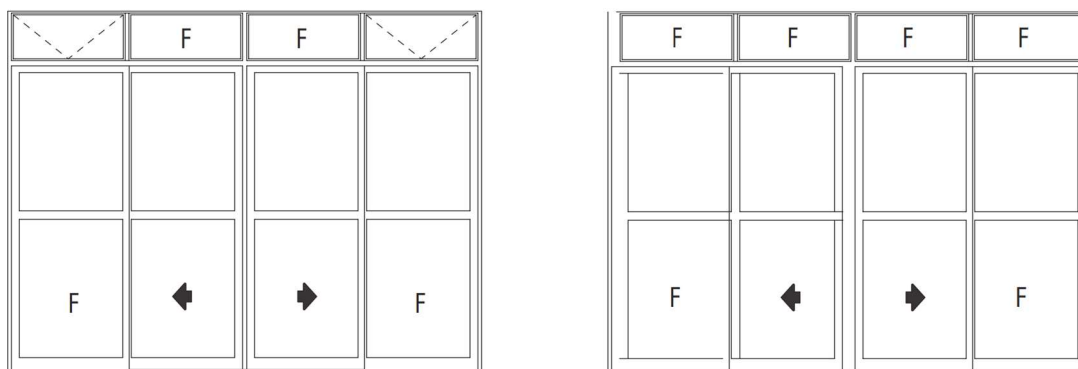
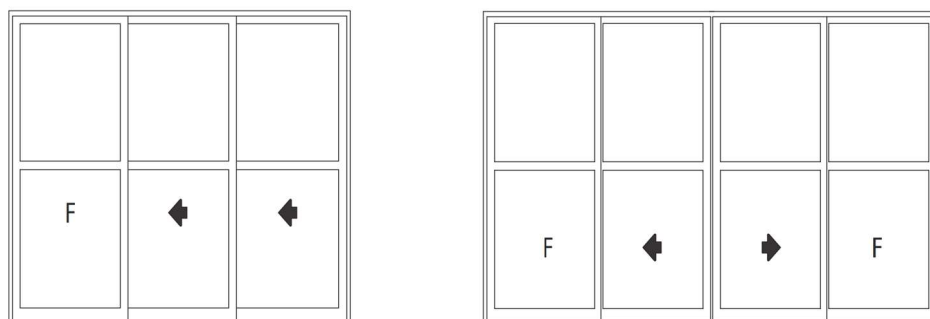
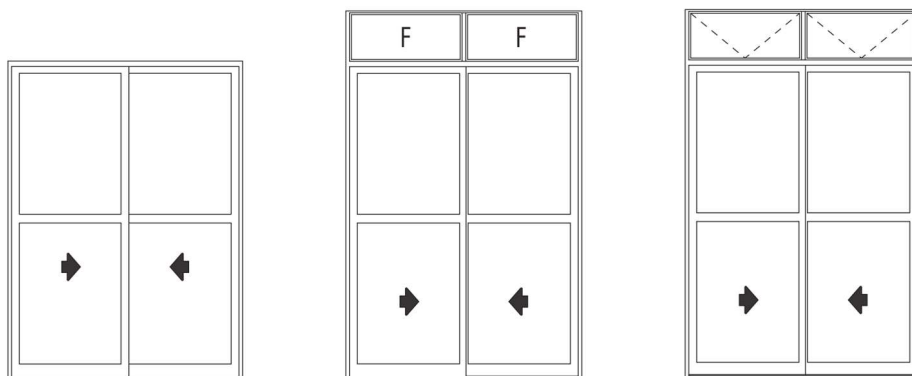

Maxim-ar

Fixo, Inferior, Superior e Múltiplo

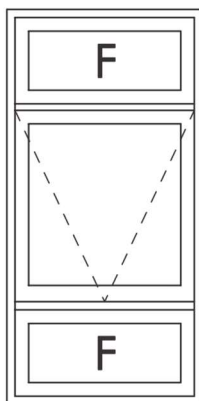
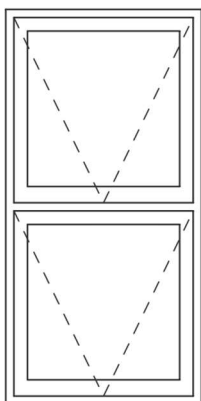
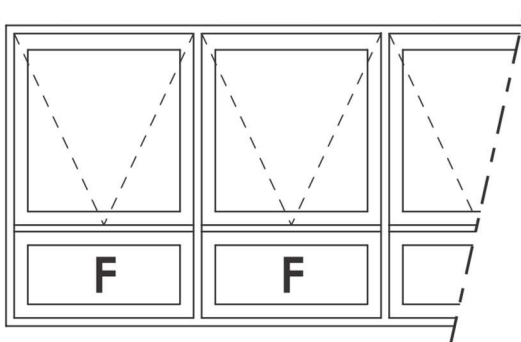
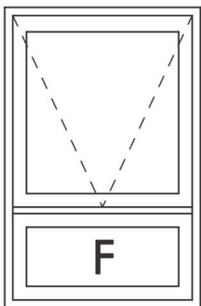
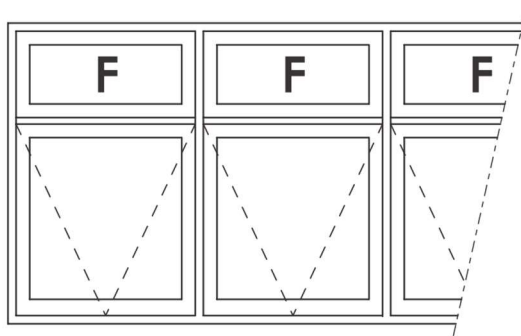
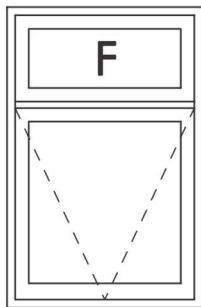
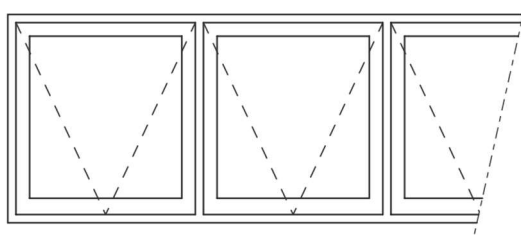
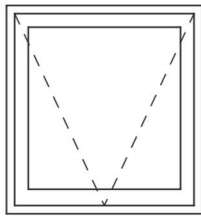

No Brasil, o comportamento de uma esquadria está regulamentado pela Norma **ABNT NBR 10.821**. Esta norma determina os parâmetros de desempenho mínimas de caixilhos em edificações residenciais e comerciais.

A velocidade do vento é o fator inicial para calcular a pressão do vento no local desejado.

### Isopletas dos Ventos

(em metros por segundo)

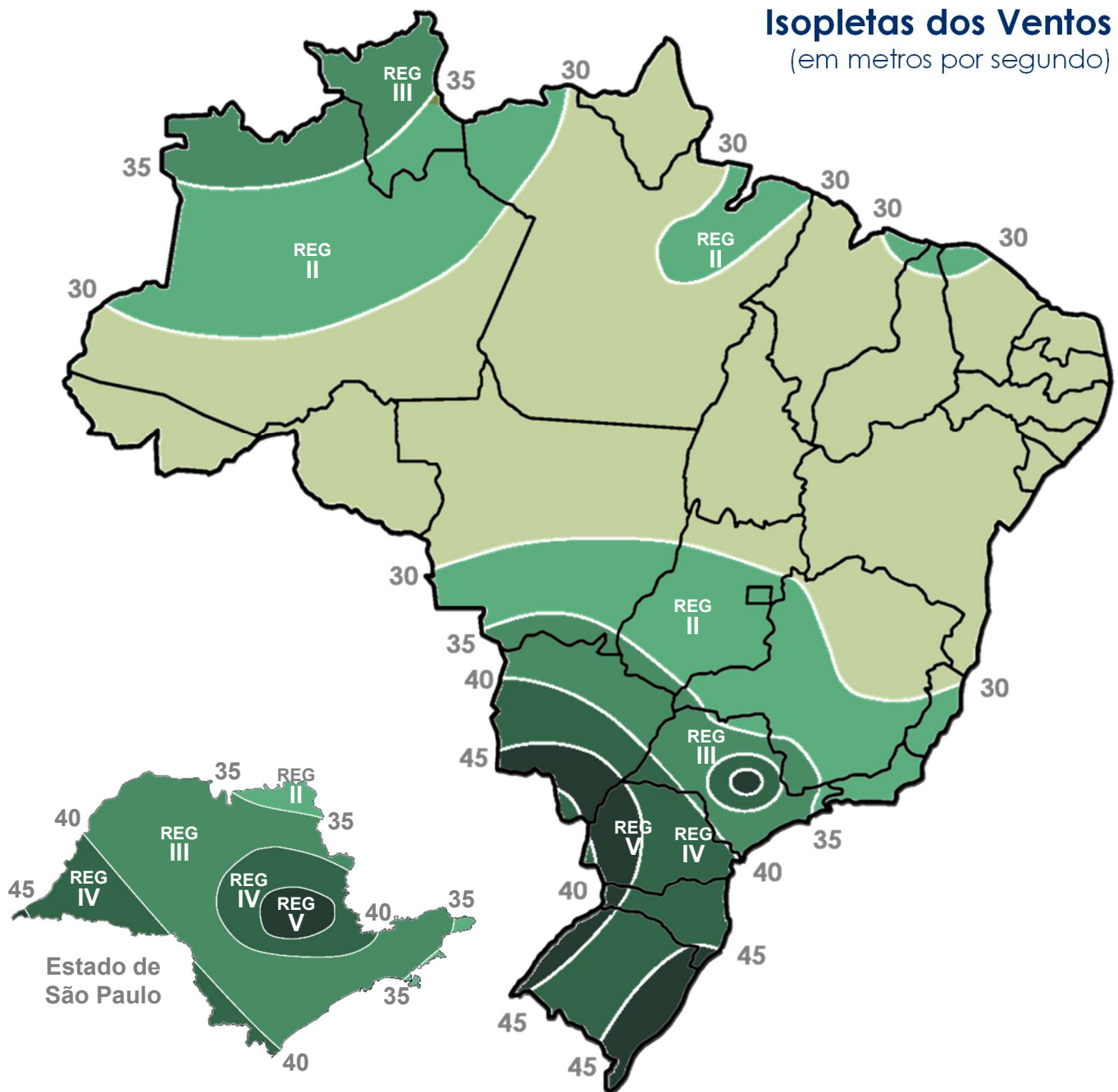

#### VELOCIDADE DO VENTO POR REGIÃO CONSIDERADA NA NORMA ABNT NBR 10.821

REGIÃO 1	REGIÃO 2	REGIÃO 3	REGIÃO 4	REGIÃO 5
até 30 m/s até 108 km/h	30 - 35 m/s 108 - 126 km/h	35 - 40 m/s 126 - 144 km/h	40 - 45 m/s 144 - 162 km/h	45 - 50 m/s 162 - 180 km/h

QUANTIDADE DE PAVIMENTOS	ALTURA MÁXIMA	REGIÕES DO PAÍS	PRESSÃO DO ENSAIO	PRESSÃO DE SEGURANÇA	PRESSÃO DE ÁGUA
			Pe em (Pa) Positiva e negativa Pe – Pp x 1,2	Ps em (Pa) Positiva e negativa Ps – Pp x 1,5	Pa em (Pa) Positiva e negativa Pa – Pp x 0,2
02	6 m	I	350	520	60
		II	470	700	80
		III	610	920	100
		IV	770	1160	130
		V	950	1430	160
05	15 m	I	420	640	70
		II	580	860	100
		III	750	1130	130
		IV	950	1430	160
		V	1180	1780	200
10	30 m	I	500	750	80
		II	680	1030	110
		III	890	1340	150
		IV	1130	1700	190
		V	1400	2090	230
20	60 m	I	600	900	100
		II	815	1220	140
		III	1060	1600	180
		IV	1350	2020	220
		V	1660	2500	280
30	90 m	I	660	980	110
		II	890	1340	150
		III	1170	1750	200
		IV	1480	2210	250
		V	1820	2730	300

JANELAS DE CORRER 2 FOLHAS

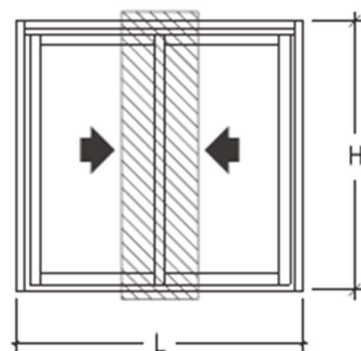
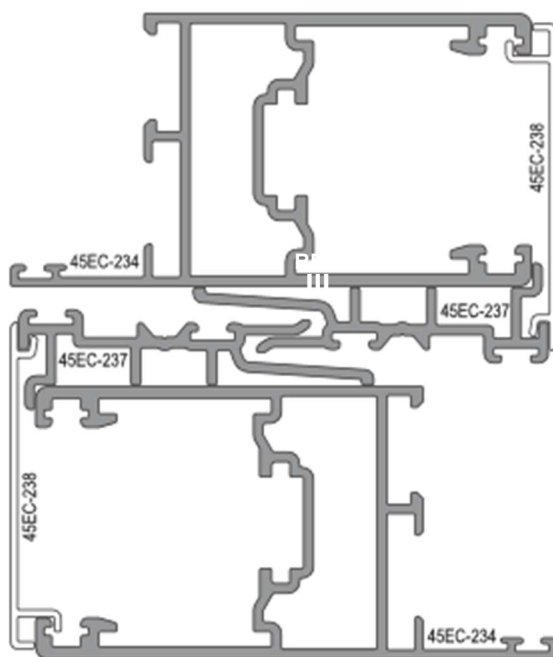

45EC-234	45EC-237	45EC-234	45EC-237
$Jx = 17,252 \text{ cm}^4$	$Jx = 0,218 \text{ cm}^4$	$Jx = 17,252 \text{ cm}^4$	$Jx = 0,218 \text{ cm}^4$
$Jy = 24,748 \text{ cm}^4$	$Jy = 5,461 \text{ cm}^4$	$Jy = 24,748 \text{ cm}^4$	$Jy = 5,461 \text{ cm}^4$
$Wx = 7,146 \text{ cm}^3$	$Wx = 0,221 \text{ cm}^3$	$Wx = 7,146 \text{ cm}^3$	$Wx = 0,221 \text{ cm}^3$
$Wy = 5,194 \text{ cm}^3$	$Wy = 1,640 \text{ cm}^3$	$Wy = 5,194 \text{ cm}^3$	$Wy = 1,640 \text{ cm}^3$
$Jx \text{ Total} = 34,940 \text{ cm}^4$		(perfil 45EC-238 não considerado no cálculo)	

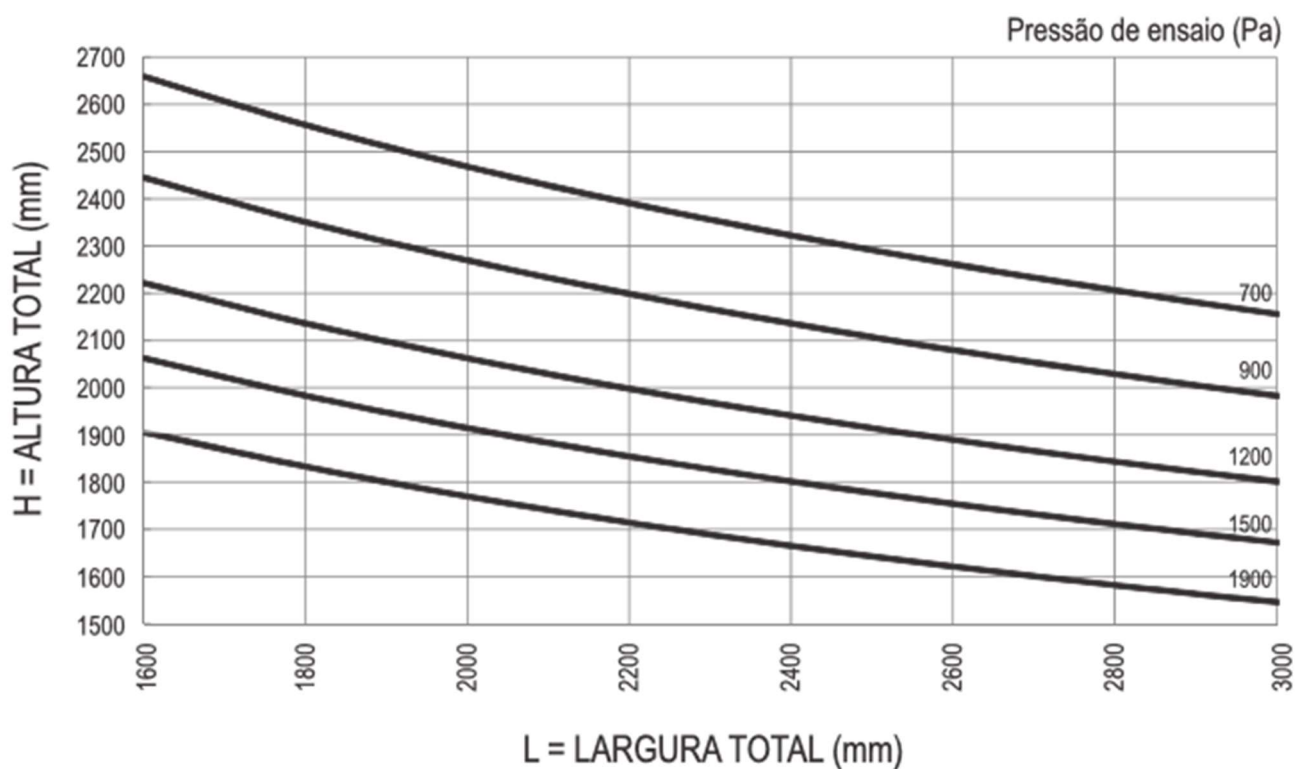

JANELAS DE CORRER 2 FOLHAS

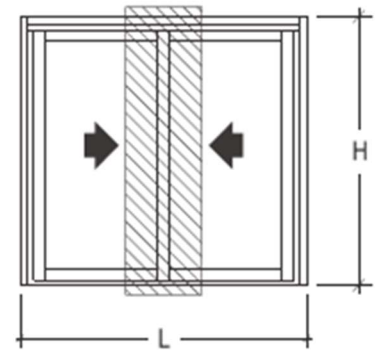
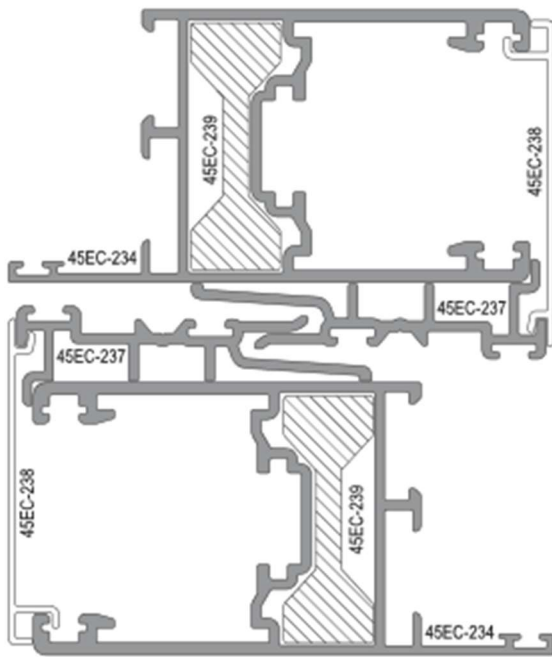

45EC-234	45EC-237	45EC-239	45EC-234	45EC-237	45EC-239
$J_x = 17,252 \text{ cm}^4$	$J_x = 0,218 \text{ cm}^4$	$J_x = 7,341 \text{ cm}^4$	$J_x = 17,252 \text{ cm}^4$	$J_x = 0,218 \text{ cm}^4$	$J_x = 7,341 \text{ cm}^4$
$J_y = 24,748 \text{ cm}^4$	$J_y = 5,461 \text{ cm}^4$	$J_y = 0,465 \text{ cm}^4$	$J_y = 24,748 \text{ cm}^4$	$J_y = 5,461 \text{ cm}^4$	$J_y = 0,465 \text{ cm}^4$
$W_x = 7,146 \text{ cm}^3$	$W_x = 0,221 \text{ cm}^3$	$W_x = 3,598 \text{ cm}^3$	$W_x = 7,146 \text{ cm}^3$	$W_x = 0,221 \text{ cm}^3$	$W_x = 3,598 \text{ cm}^3$
$W_y = 5,194 \text{ cm}^3$	$W_y = 1,640 \text{ cm}^3$	$W_y = 0,628 \text{ cm}^3$	$W_y = 5,194 \text{ cm}^3$	$W_y = 1,640 \text{ cm}^3$	$W_y = 0,628 \text{ cm}^3$
$J_x \text{ Total} = 49,622 \text{ cm}^4$			(perfil 45EC-238 não considerado no cálculo)		

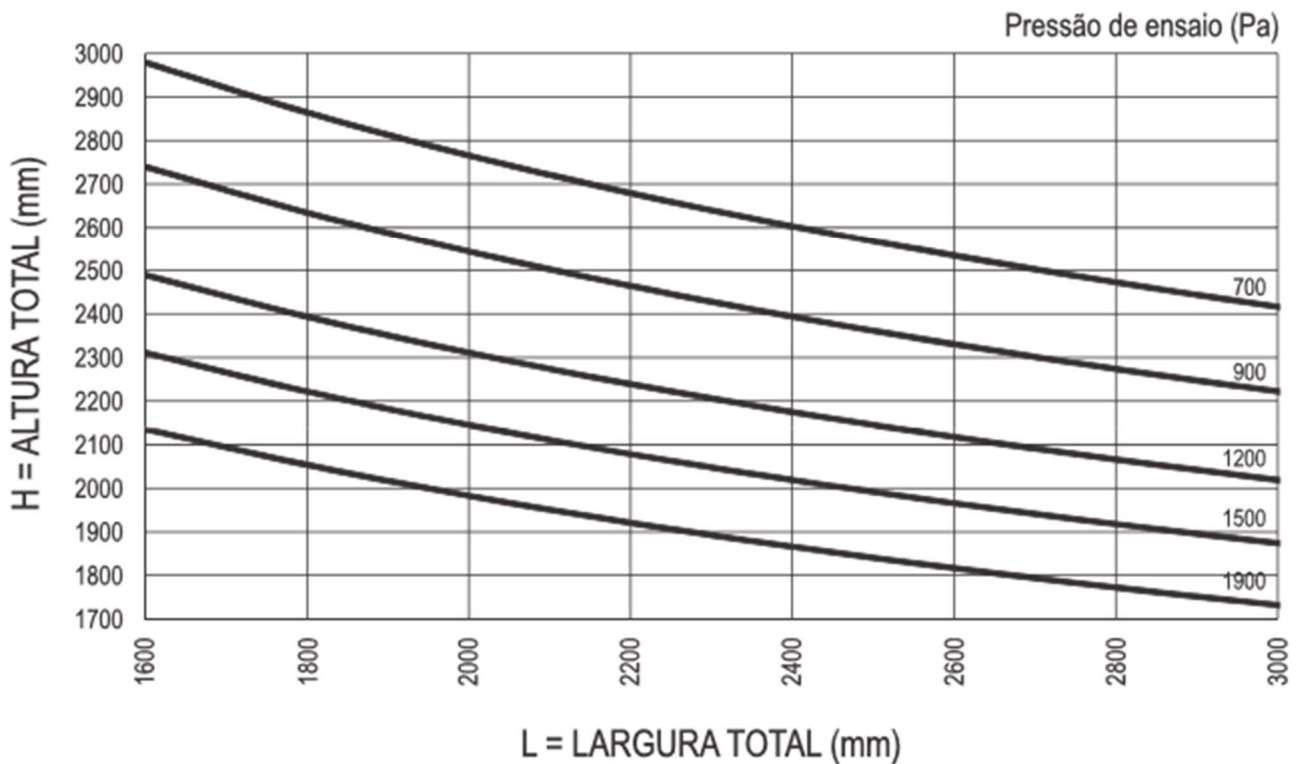

PORTA DE CORRER 2 FOLHAS

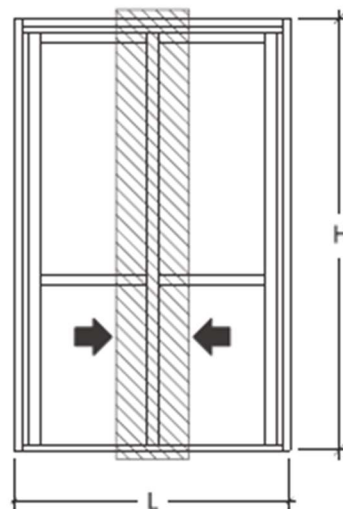
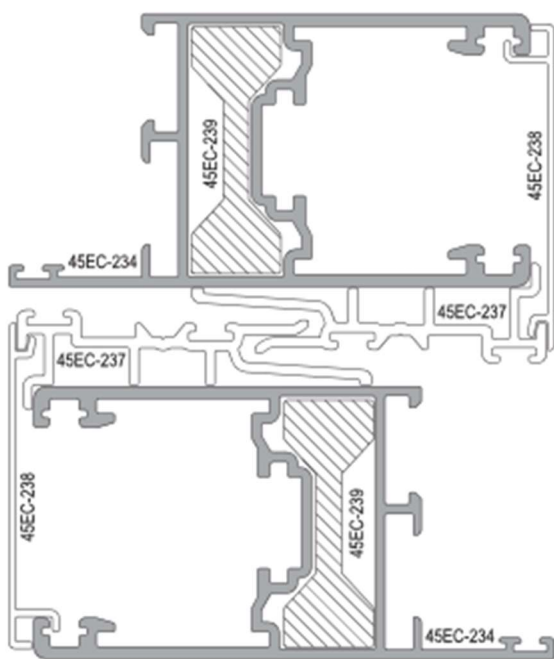

<p><b>45EC-234</b></p> <p>Jx = 17,252 cm<sup>4</sup>                  Jy = 24,748 cm<sup>4</sup>                  Wx = 7,146 cm<sup>3</sup>                  Wy = 5,194 cm<sup>3</sup></p>	<p><b>45EC-237</b></p> <p>Jx = 0,218 cm<sup>4</sup>                  Jy = 5,461 cm<sup>4</sup>                  Wx = 0,221 cm<sup>3</sup>                  Wy = 1,640 cm<sup>3</sup></p>	<p><b>45EC-239</b></p> <p>Jx = 7,341 cm<sup>4</sup>                  Jy = 0,465 cm<sup>4</sup>                  Wx = 3,598 cm<sup>3</sup>                  Wy = 0,628 cm<sup>3</sup></p>	<p><b>45EC-235</b></p> <p>Jx = 40,823 cm<sup>4</sup>                  Jy = 28,022 cm<sup>4</sup>                  Wx = 10,089 cm<sup>3</sup>                  Wy = 6,354 cm<sup>3</sup></p>	<p><b>45EC-237</b></p> <p>Jx = 0,218 cm<sup>4</sup>                  Jy = 5,461 cm<sup>4</sup>                  Wx = 0,221 cm<sup>3</sup>                  Wy = 1,640 cm<sup>3</sup></p>	<p><b>45EC-239</b></p> <p>Jx = 7,341 cm<sup>4</sup>                  Jy = 0,465 cm<sup>4</sup>                  Wx = 3,598 cm<sup>3</sup>                  Wy = 0,628 cm<sup>3</sup></p>
<p>Jx Total = 73,193 cm<sup>4</sup> (perfil 45EC-235 não considerado no cálculo)</p>					

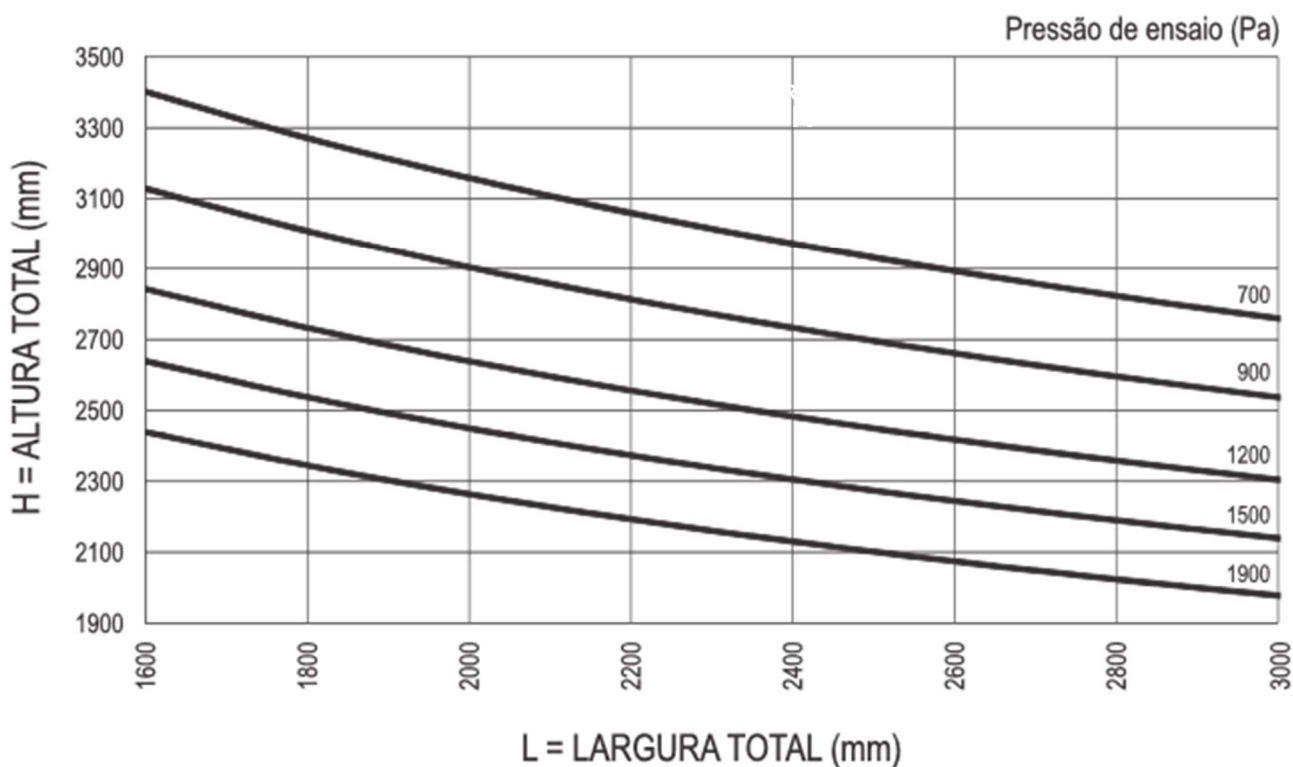

JANELA/PORTA DE CORRER 2 FOLHAS

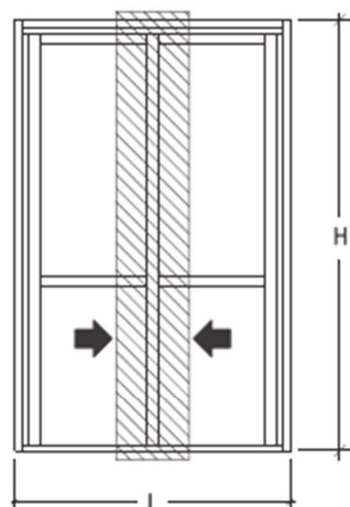
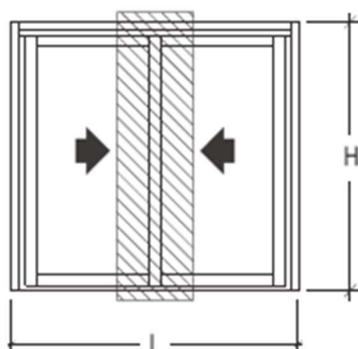
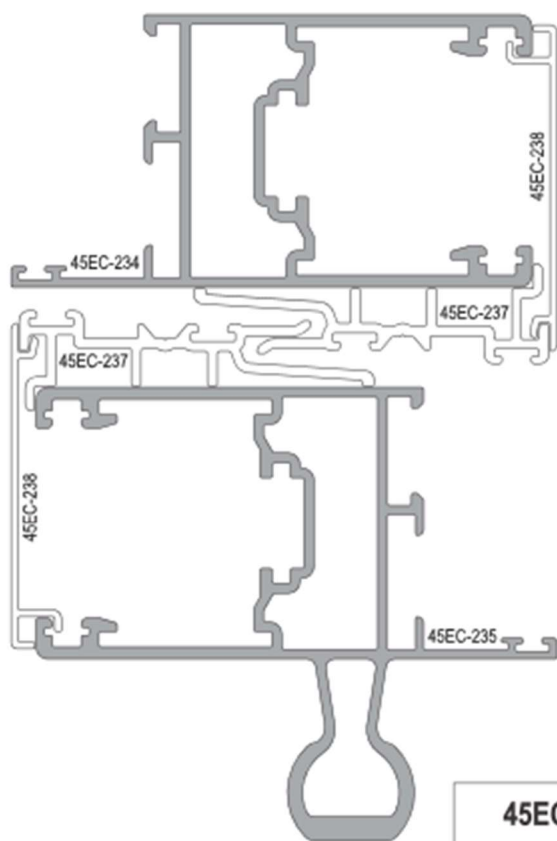

45EC-234	45EC-237	45EC-235	45EC-237
$J_x = 17,252 \text{ cm}^4$	$J_x = 0,218 \text{ cm}^4$	$J_x = 40,823 \text{ cm}^4$	$J_x = 0,218 \text{ cm}^4$
$J_y = 24,748 \text{ cm}^4$	$J_y = 5,461 \text{ cm}^4$	$J_y = 28,022 \text{ cm}^4$	$J_y = 5,461 \text{ cm}^4$
$W_x = 7,146 \text{ cm}^3$	$W_x = 0,221 \text{ cm}^3$	$W_x = 10,089 \text{ cm}^3$	$W_x = 0,221 \text{ cm}^3$
$W_y = 5,194 \text{ cm}^3$	$W_y = 1,640 \text{ cm}^3$	$W_y = 6,354 \text{ cm}^3$	$W_y = 1,640 \text{ cm}^3$
$J_x \text{ Total} = 58,511 \text{ cm}^4$		(perfil 45EC-238 não considerado no cálculo)	

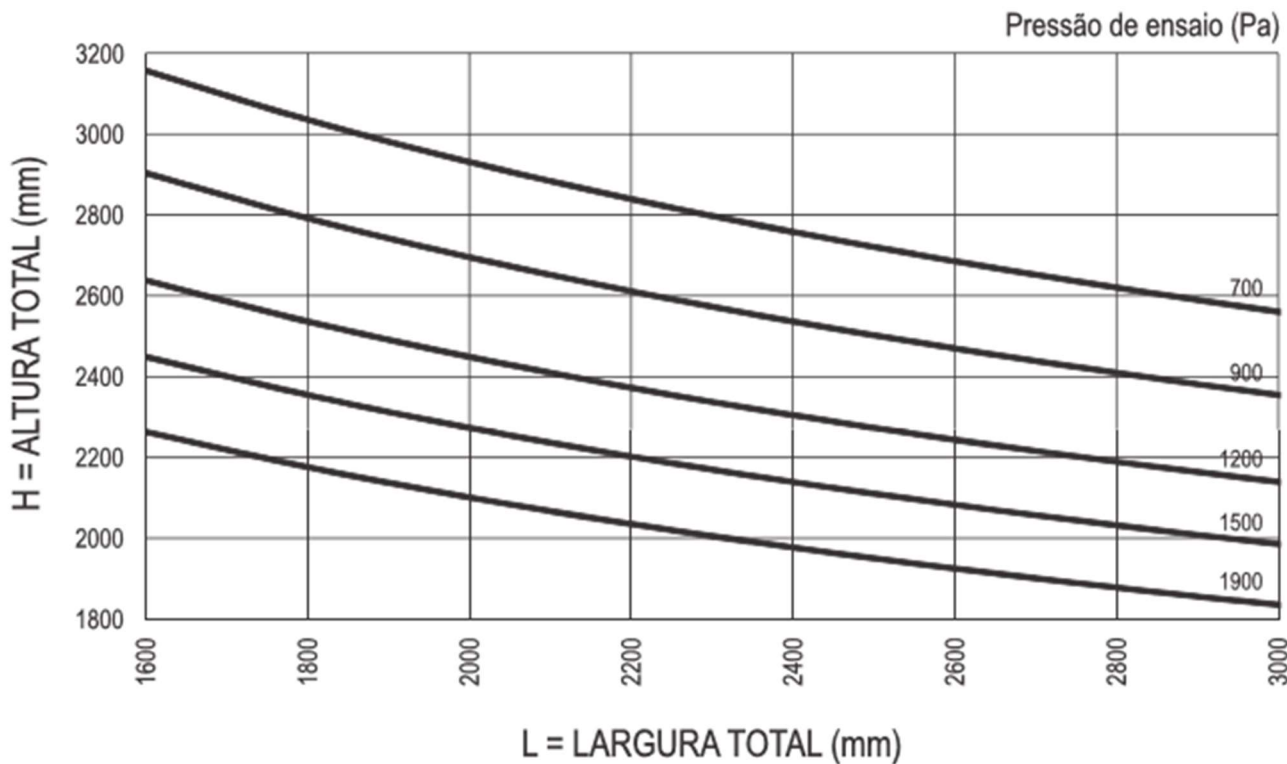



PORTA DE CORRER 2 FOLHAS

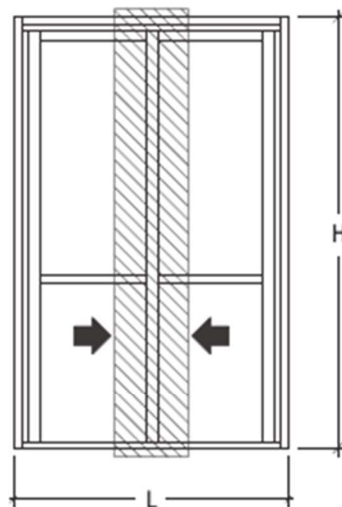
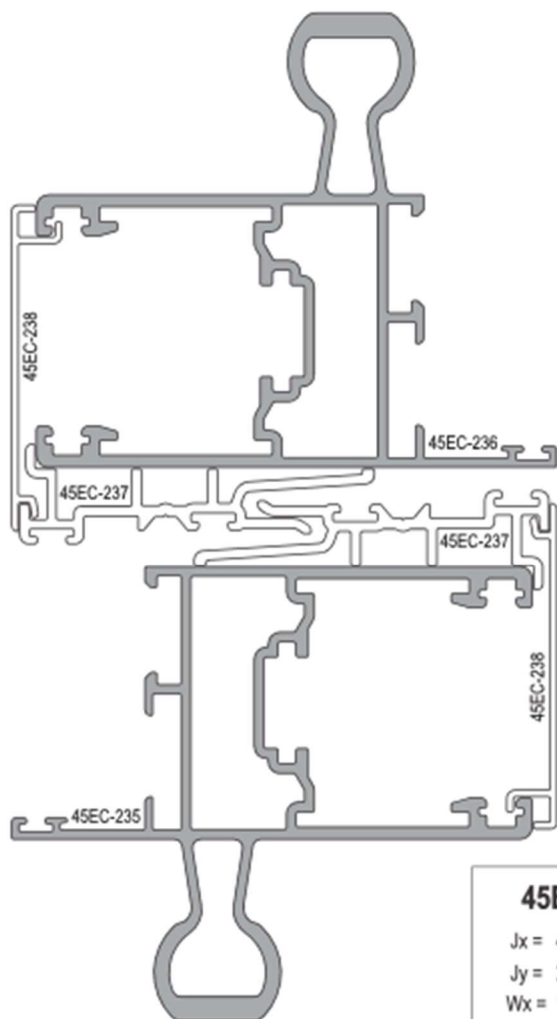

45EC-236	45EC-237	45EC-235	45EC-237
$J_x = 44,580 \text{ cm}^4$	$J_x = 0,218 \text{ cm}^4$	$J_x = 40,823 \text{ cm}^4$	$J_x = 0,218 \text{ cm}^4$
$J_y = 28,022 \text{ cm}^4$	$J_y = 5,461 \text{ cm}^4$	$J_y = 28,022 \text{ cm}^4$	$J_y = 5,461 \text{ cm}^4$
$W_x = 10,396 \text{ cm}^3$	$W_x = 0,221 \text{ cm}^3$	$W_x = 10,089 \text{ cm}^3$	$W_x = 0,221 \text{ cm}^3$
$W_y = 6,354 \text{ cm}^3$	$W_y = 1,640 \text{ cm}^3$	$W_y = 6,354 \text{ cm}^3$	$W_y = 1,640 \text{ cm}^3$
$J_x \text{ Total} = 85,839 \text{ cm}^4$		(perfil 45EC-238 não considerado no cálculo)	

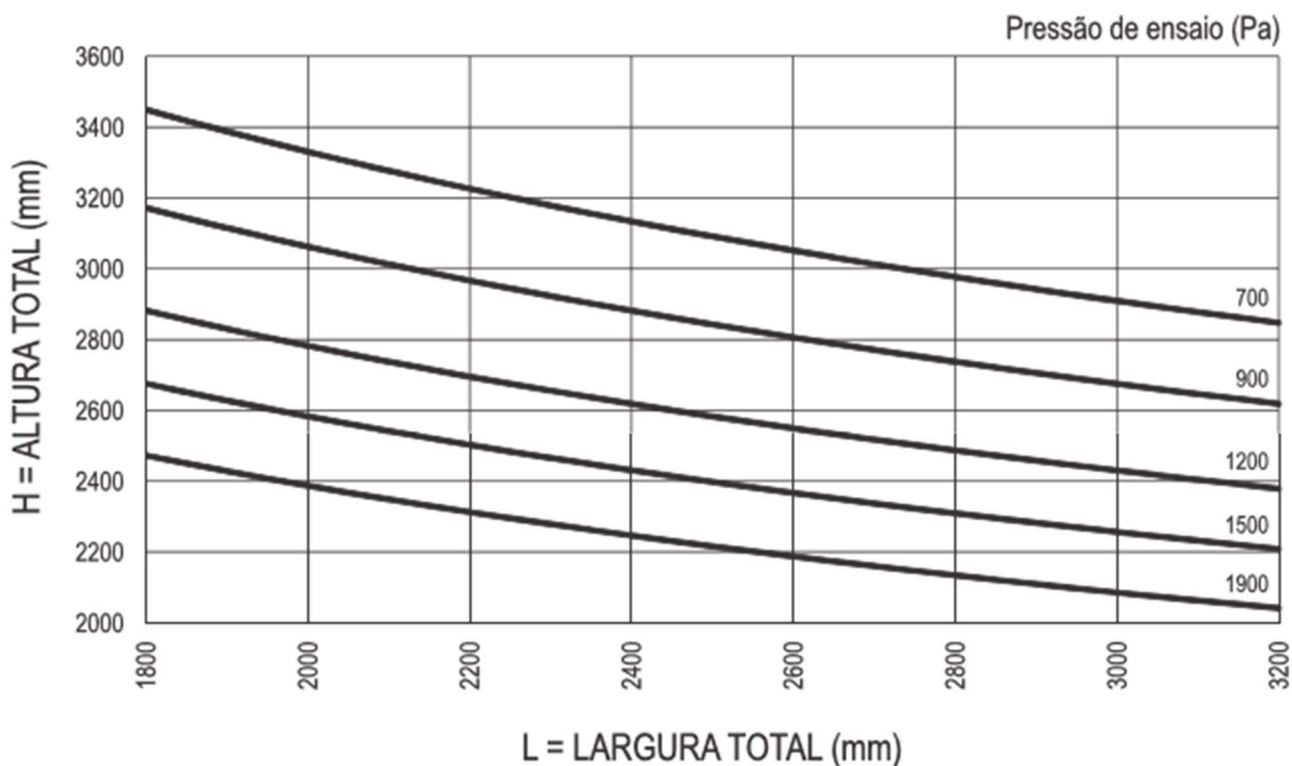

PORTA DE CORRER 2 FOLHAS

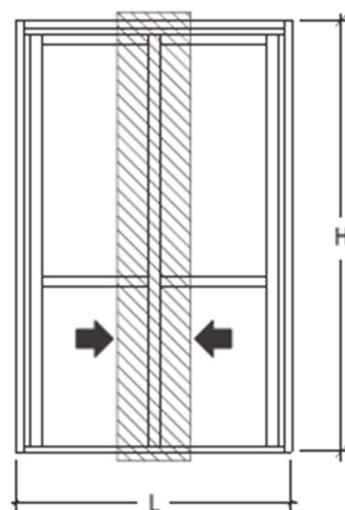
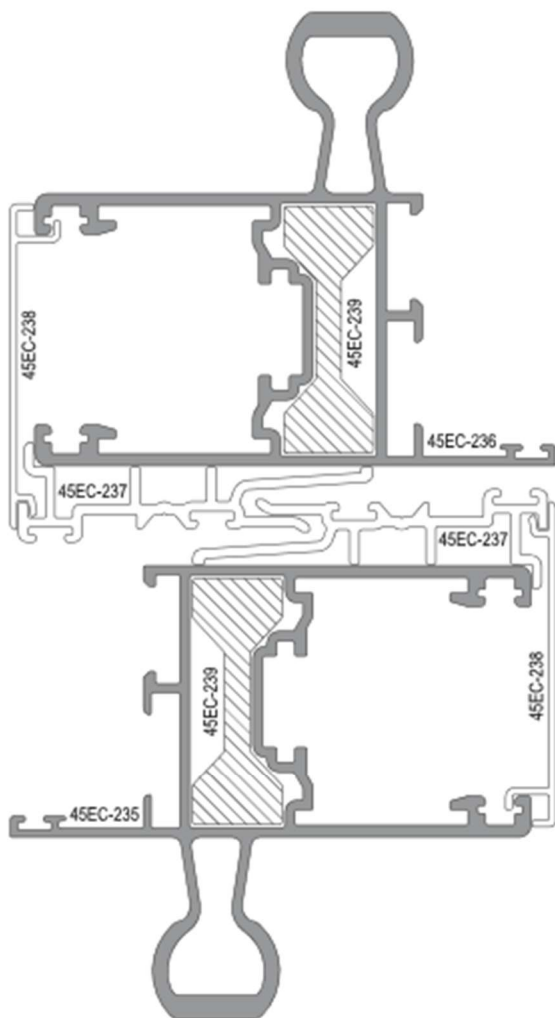

<p><b>45EC-236</b></p> <p>Jx = 44,580 cm<sup>4</sup>                      Jy = 28,022 cm<sup>4</sup>                      Wx = 10,396 cm<sup>3</sup>                      Wy = 6,354 cm<sup>3</sup></p>	<p><b>45EC-237</b></p> <p>Jx = 0,218 cm<sup>4</sup>                      Jy = 5,461 cm<sup>4</sup>                      Wx = 0,221 cm<sup>3</sup>                      Wy = 1,640 cm<sup>3</sup></p>	<p><b>45EC-239</b></p> <p>Jx = 7,341 cm<sup>4</sup>                      Jy = 0,465 cm<sup>4</sup>                      Wx = 3,598 cm<sup>3</sup>                      Wy = 0,628 cm<sup>3</sup></p>
<p><b>45EC-235</b></p> <p>Jx = 40,823 cm<sup>4</sup>                      Jy = 28,022 cm<sup>4</sup>                      Wx = 10,089 cm<sup>3</sup>                      Wy = 6,354 cm<sup>3</sup></p>	<p><b>45EC-237</b></p> <p>Jx = 0,218 cm<sup>4</sup>                      Jy = 5,461 cm<sup>4</sup>                      Wx = 0,221 cm<sup>3</sup>                      Wy = 1,640 cm<sup>3</sup></p>	<p><b>45EC-239</b></p> <p>Jx = 7,341 cm<sup>4</sup>                      Jy = 0,465 cm<sup>4</sup>                      Wx = 3,598 cm<sup>3</sup>                      Wy = 0,628 cm<sup>3</sup></p>
<p>Jx Total = 100,521 cm<sup>4</sup> (perfil 45EC-238 não considerado no cálculo)</p>		

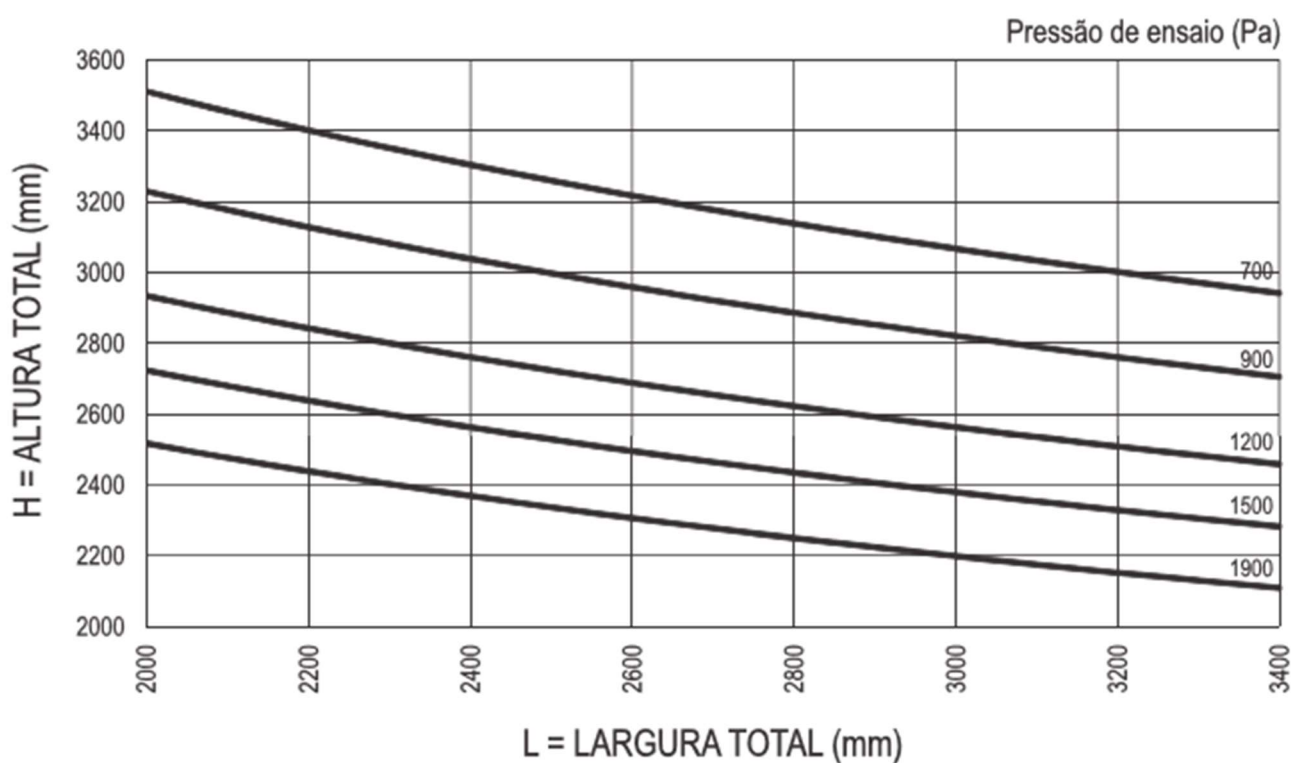

PORTA DE CORRER 4 FOLHAS

<p><b>45EC-235</b></p> <p>Jx = 40,823 cm<sup>4</sup>          Jy = 28,022 cm<sup>4</sup>          Wx = 10,089 cm<sup>3</sup>          Wy = 6,354 cm<sup>3</sup></p>	<p><b>45EC-239</b></p> <p>Jx = 7,341 cm<sup>4</sup>          Jy = 0,465 cm<sup>4</sup>          Wx = 3,598 cm<sup>3</sup>          Wy = 0,628 cm<sup>3</sup></p>
<p><b>45EC-235</b></p> <p>Jx = 40,823 cm<sup>4</sup>          Jy = 28,022 cm<sup>4</sup>          Wx = 10,089 cm<sup>3</sup>          Wy = 6,354 cm<sup>3</sup></p>	<p><b>45EC-239</b></p> <p>Jx = 7,341 cm<sup>4</sup>          Jy = 0,465 cm<sup>4</sup>          Wx = 3,598 cm<sup>3</sup>          Wy = 0,628 cm<sup>3</sup></p>
<p><b>Jx Total = 96,328 cm<sup>4</sup></b>          (perfil 45EC-299 não considerado no cálculo)</p>	

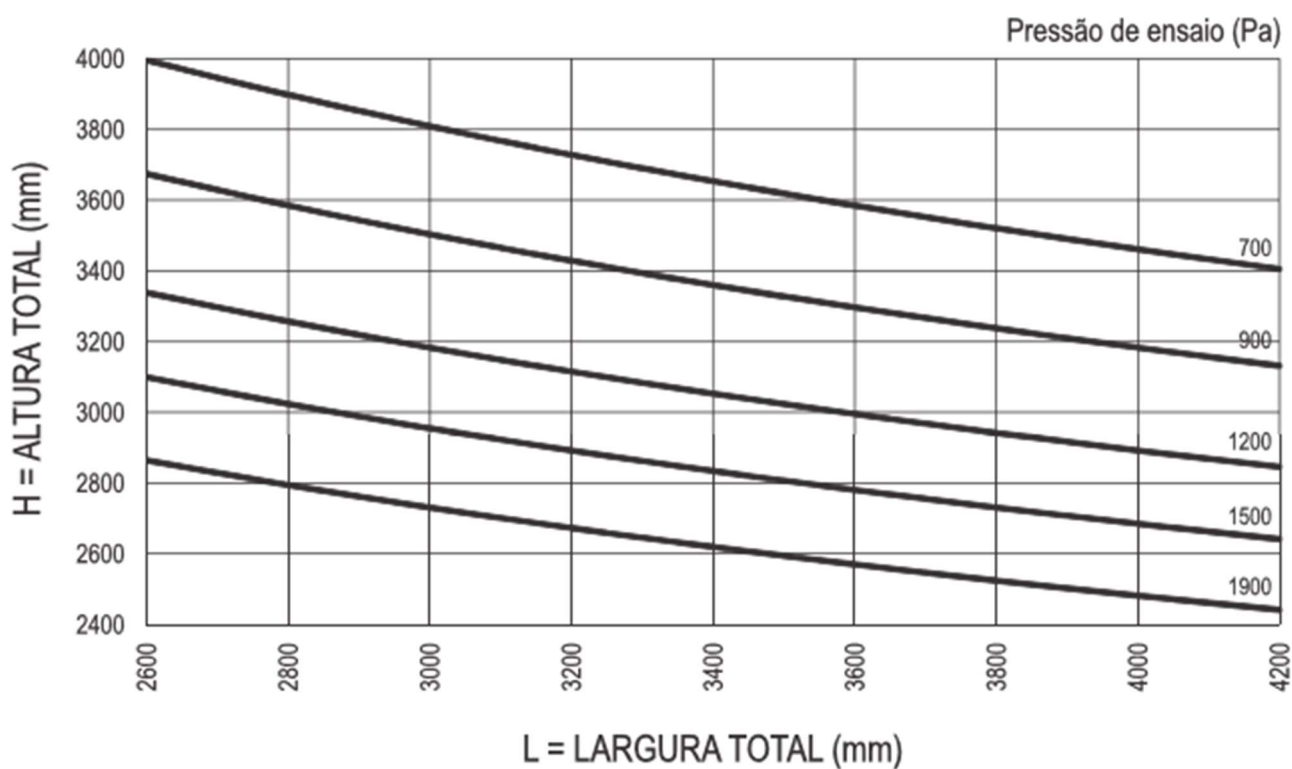
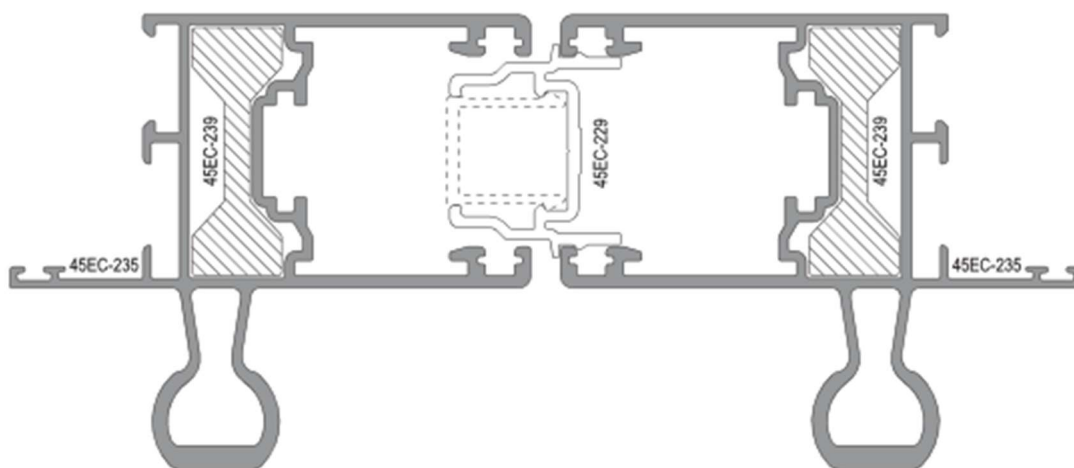
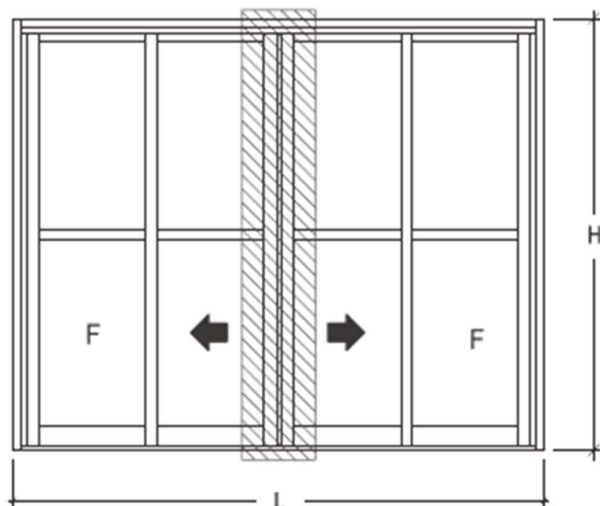

JANELA DE CORRER 4 FOLHAS

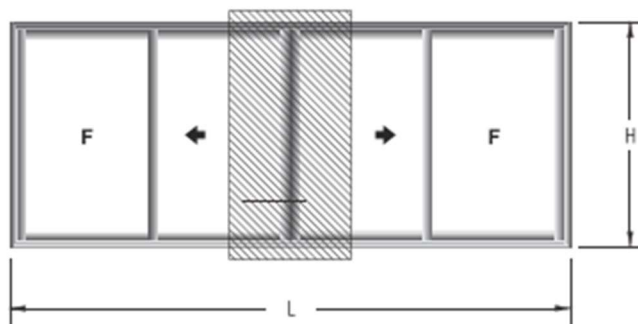

<b>45EC-234</b>	<b>45EC-239</b>	<b>45EC-234</b>	<b>45EC-239</b>
$J_x = 17,252 \text{ cm}^4$	$J_x = 7,341 \text{ cm}^4$	$J_x = 17,252 \text{ cm}^4$	$J_x = 7,341 \text{ cm}^4$
$J_y = 24,748 \text{ cm}^4$	$J_y = 0,465 \text{ cm}^4$	$J_y = 24,748 \text{ cm}^4$	$J_y = 0,465 \text{ cm}^4$
$W_x = 7,146 \text{ cm}^3$	$W_x = 3,598 \text{ cm}^3$	$W_x = 7,146 \text{ cm}^3$	$W_x = 3,598 \text{ cm}^3$
$W_y = 5,194 \text{ cm}^3$	$W_y = 0,628 \text{ cm}^3$	$W_y = 5,194 \text{ cm}^3$	$W_y = 0,628 \text{ cm}^3$
$J_x \text{ Total} = 49,186 \text{ cm}^4$		(perfil 45EC-229 não considerado no cálculo)	

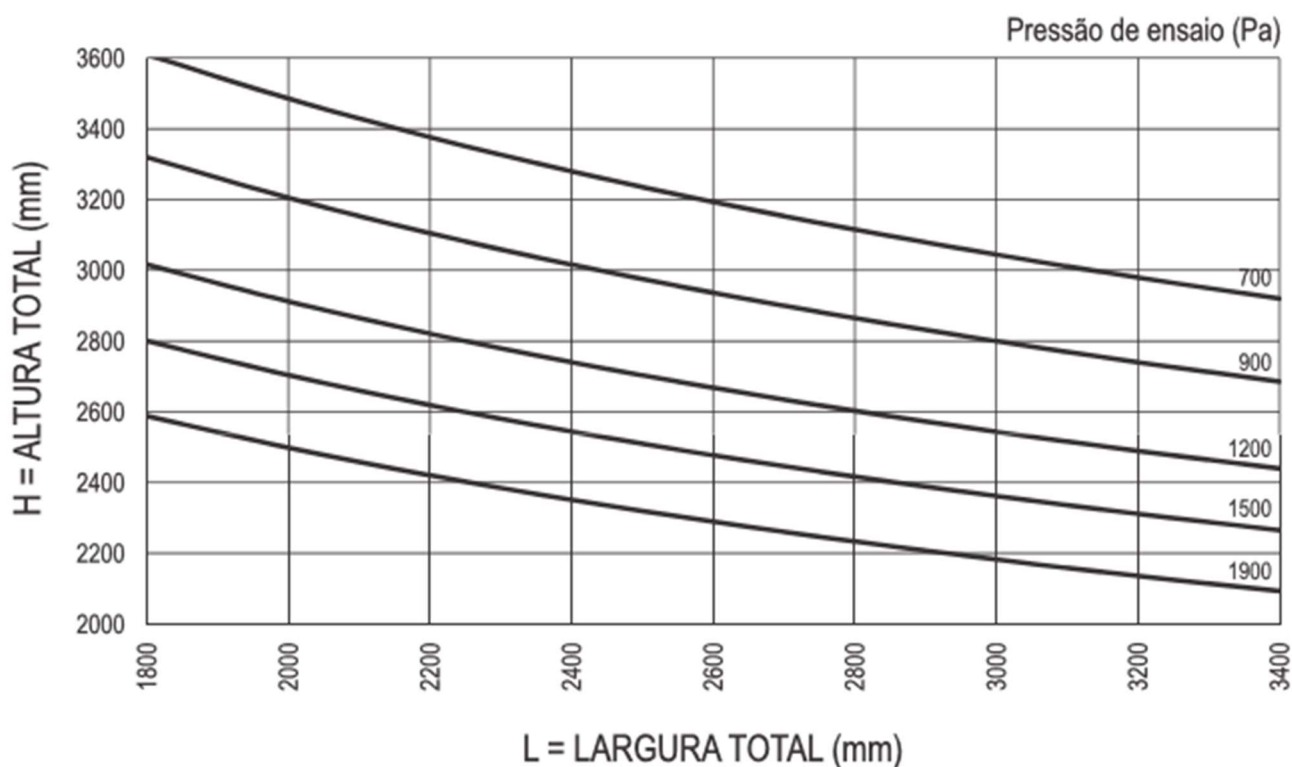
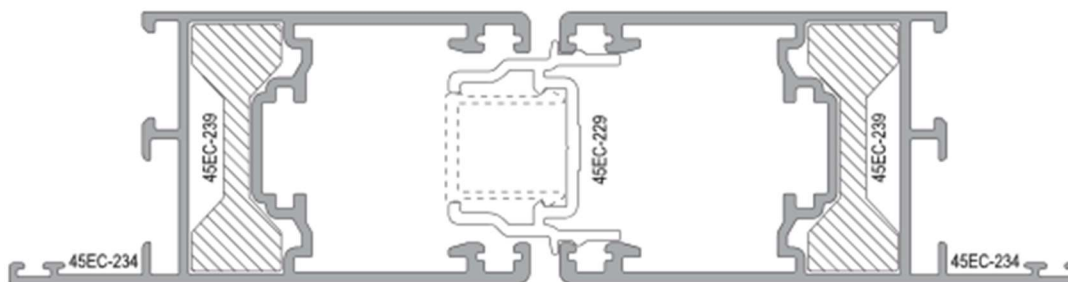

JANELA DE CORRER 4 FOLHAS

<b>45EC-234</b> Jx = 17,252 cm <sup>4</sup> Jy = 24,748 cm <sup>4</sup> Wx = 7,146 cm <sup>3</sup> Wy = 5,194 cm <sup>3</sup>	<b>45EC-234</b> Jx = 17,252 cm <sup>4</sup> Jy = 24,748 cm <sup>4</sup> Wx = 7,146 cm <sup>3</sup> Wy = 5,194 cm <sup>3</sup>
Jx Total = 34,504 cm <sup>4</sup> (perfil 45EC-229 não considerado no cálculo)	

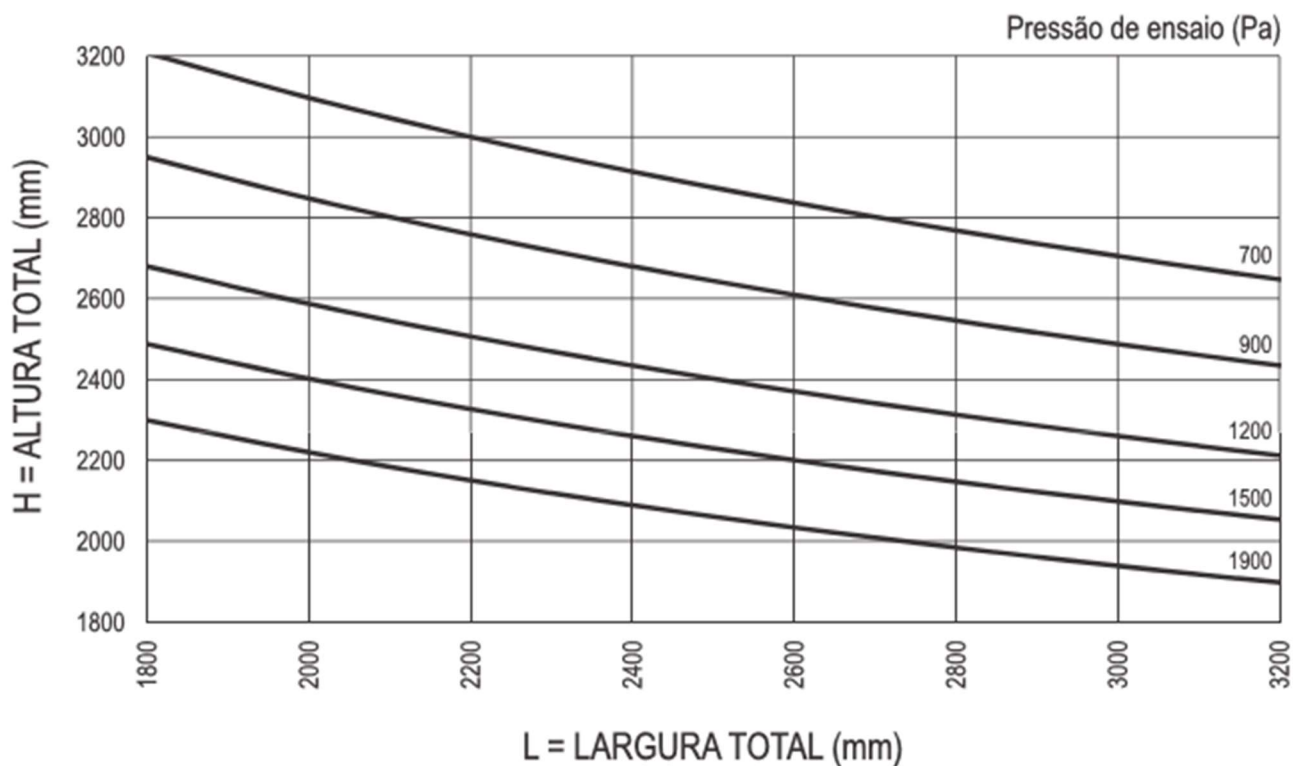
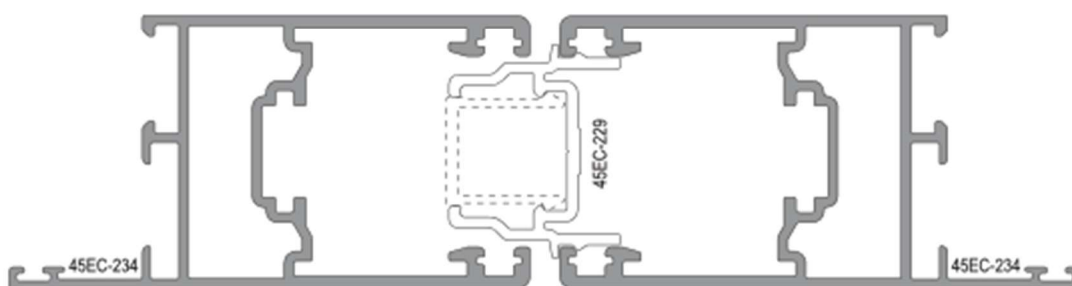
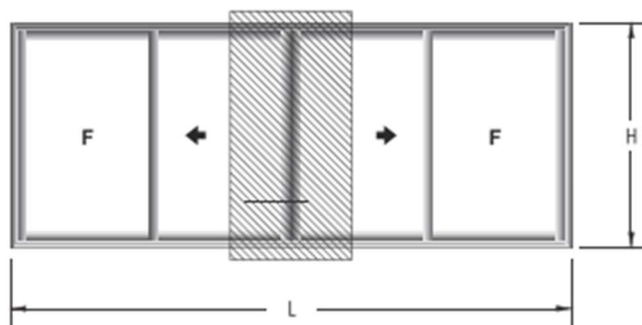

PORTA DE CORRER 2 FOLHAS

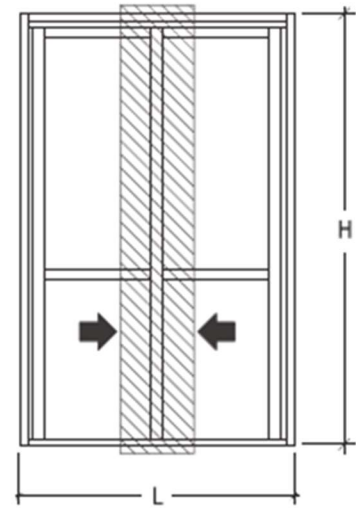
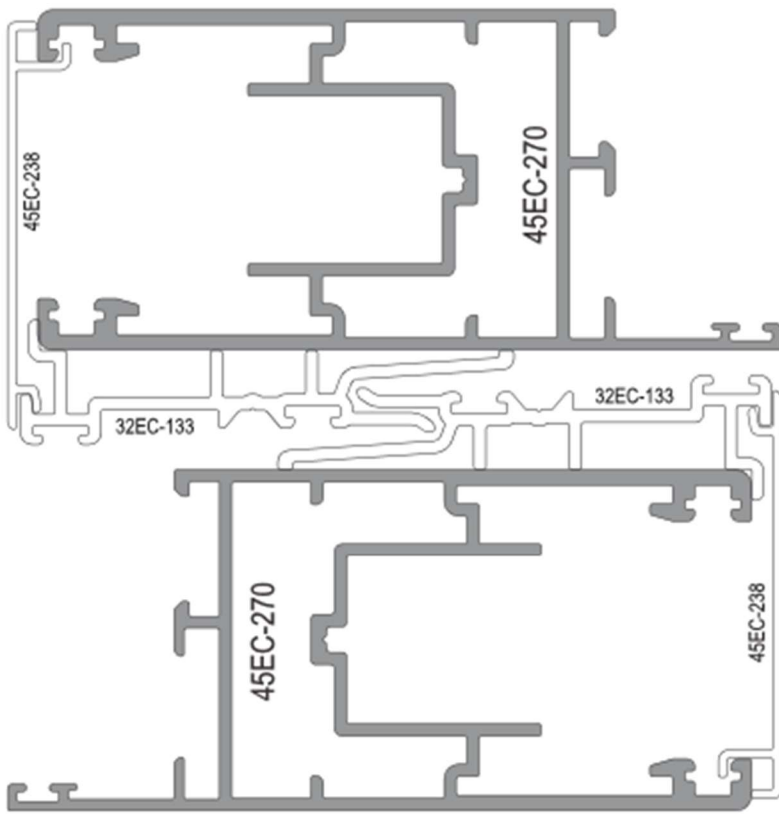

<b>45EC-270</b>	<b>45EC-270</b>
Jx = 20,336 cm <sup>4</sup>	Jx = 20,336 cm <sup>4</sup>
Jy = 38,912 cm <sup>4</sup>	Jy = 38,912 cm <sup>4</sup>
Wx = 8,526 cm <sup>3</sup>	Wx = 8,526 cm <sup>3</sup>
Wy = 7,215 cm <sup>3</sup>	Wy = 7,215 cm <sup>3</sup>
<b>Jx Total = 40,672 cm<sup>4</sup></b>	

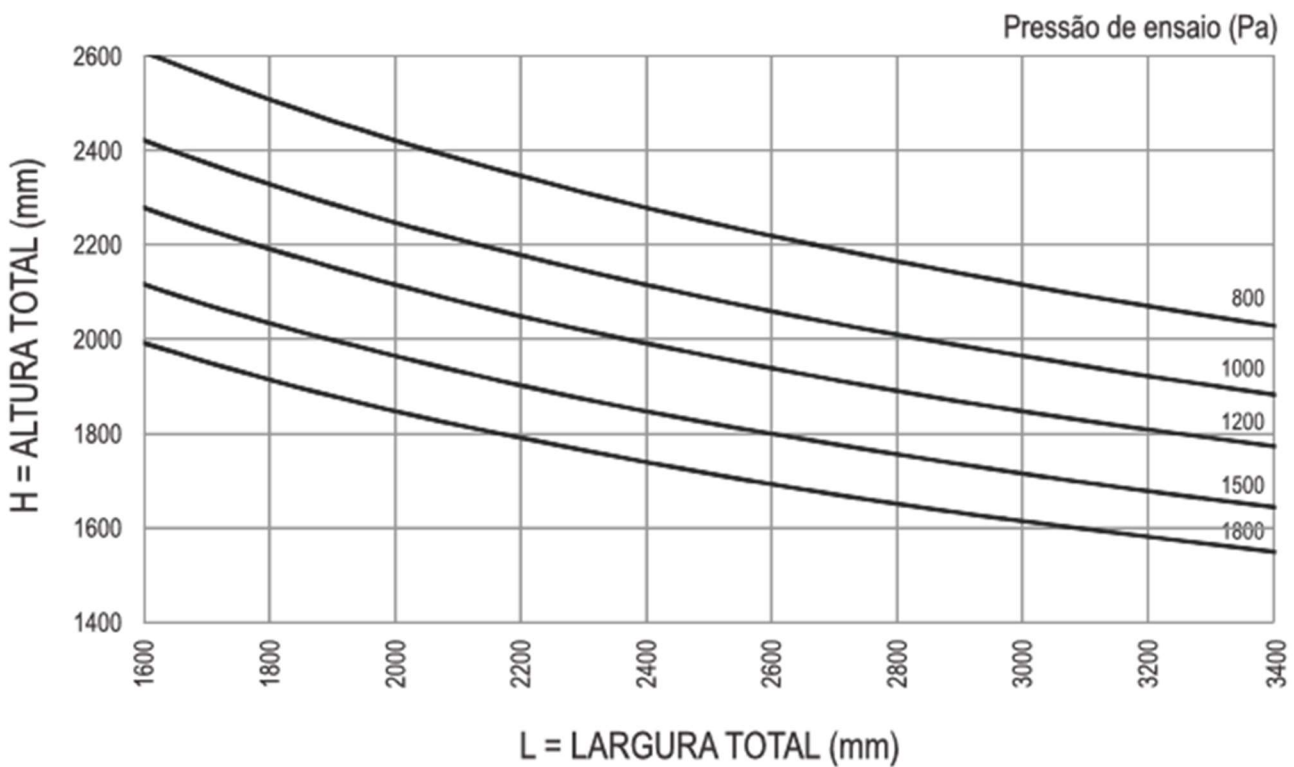

PORTA DE CORRER 2 FOLHAS

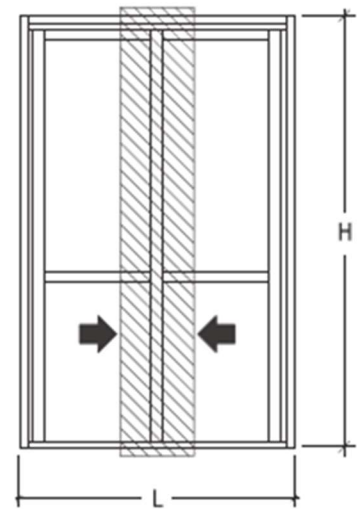
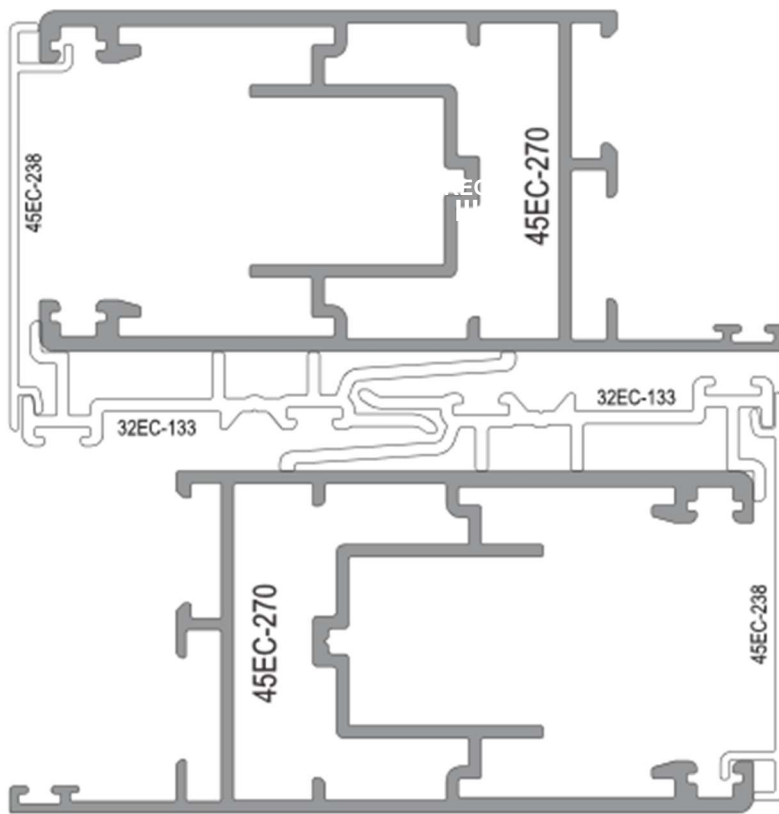

45EC-270	45EC-270
$J_x = 20,336 \text{ cm}^4$	$J_x = 20,336 \text{ cm}^4$
$J_y = 38,912 \text{ cm}^4$	$J_y = 38,912 \text{ cm}^4$
$W_x = 8,526 \text{ cm}^3$	$W_x = 8,526 \text{ cm}^3$
$W_y = 7,215 \text{ cm}^3$	$W_y = 7,215 \text{ cm}^3$
<b><math>J_x \text{ Total} = 40,672 \text{ cm}^4</math></b>	

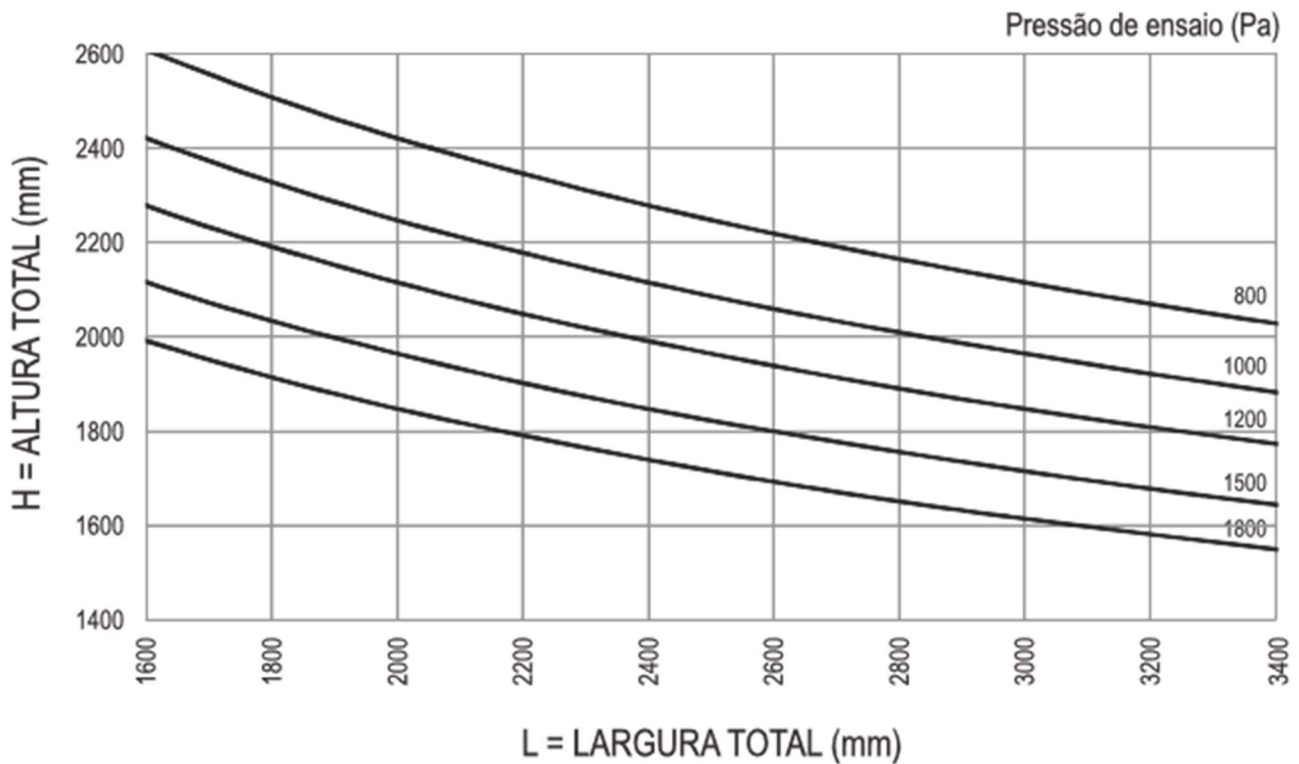

PORTA DE CORRER 2 FOLHAS

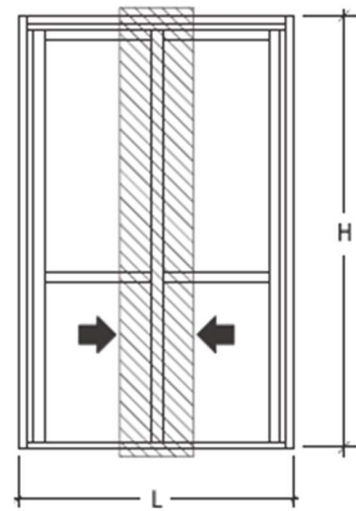
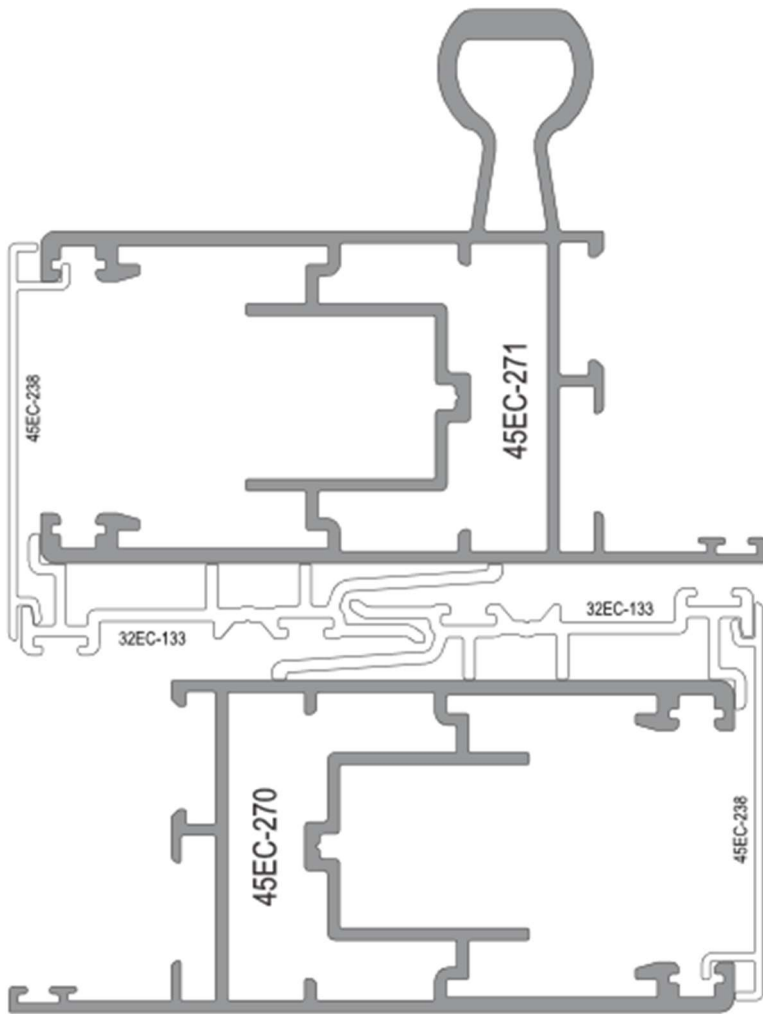

45EC-270	45EC-271
$Jx = 20,336 \text{ cm}^4$	$Jx = 48,561 \text{ cm}^4$
$Jy = 38,912 \text{ cm}^4$	$Jy = 45,314 \text{ cm}^4$
$Wx = 8,526 \text{ cm}^3$	$Wx = 10,994 \text{ cm}^3$
$Wy = 7,215 \text{ cm}^3$	$Wy = 9,159 \text{ cm}^3$
$Jx \text{ Total} = 68,897 \text{ cm}^4$	

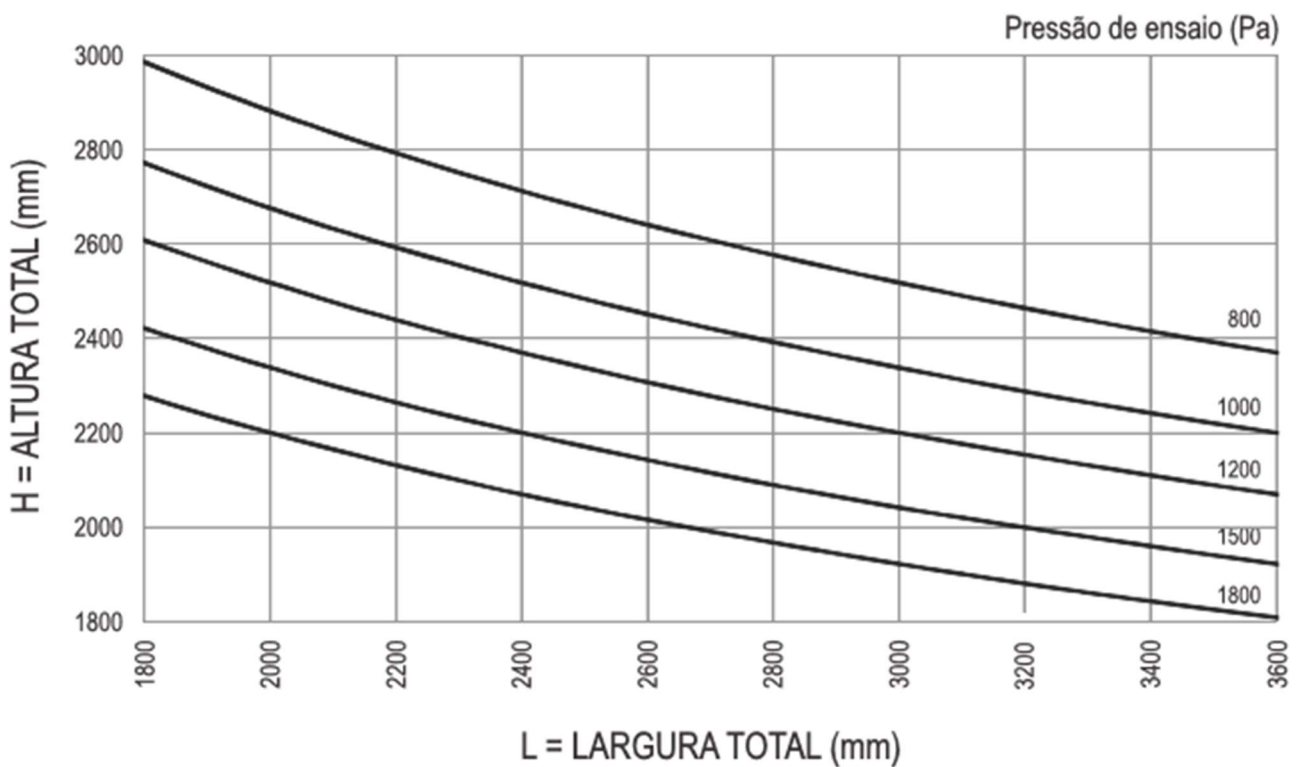



PORTA DE CORRER 2 FOLHAS

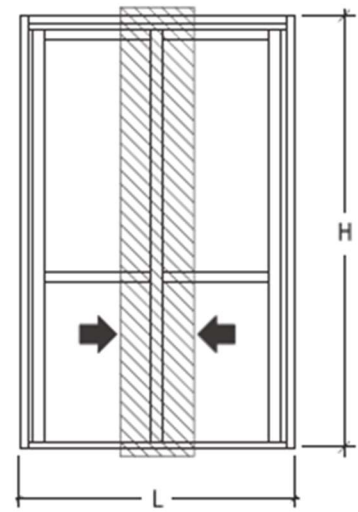
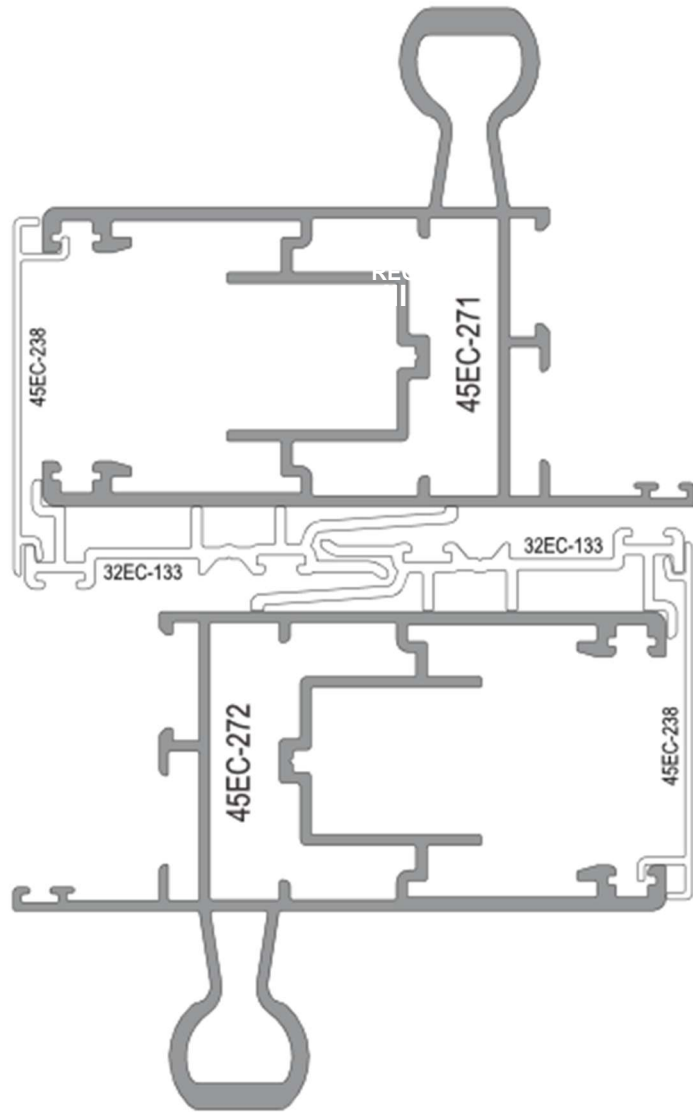

45EC-271	45EC-272
Jx = 48,561 cm <sup>4</sup>	Jx = 45,302 cm <sup>4</sup>
Jy = 45,314 cm <sup>4</sup>	Jy = 45,314 cm <sup>4</sup>
Wx = 10,994 cm <sup>3</sup>	Wx = 10,740 cm <sup>3</sup>
Wy = 9,159 cm <sup>3</sup>	Wy = 9,159 cm <sup>3</sup>
<b>Jx Total = 93,863 cm<sup>4</sup></b>	

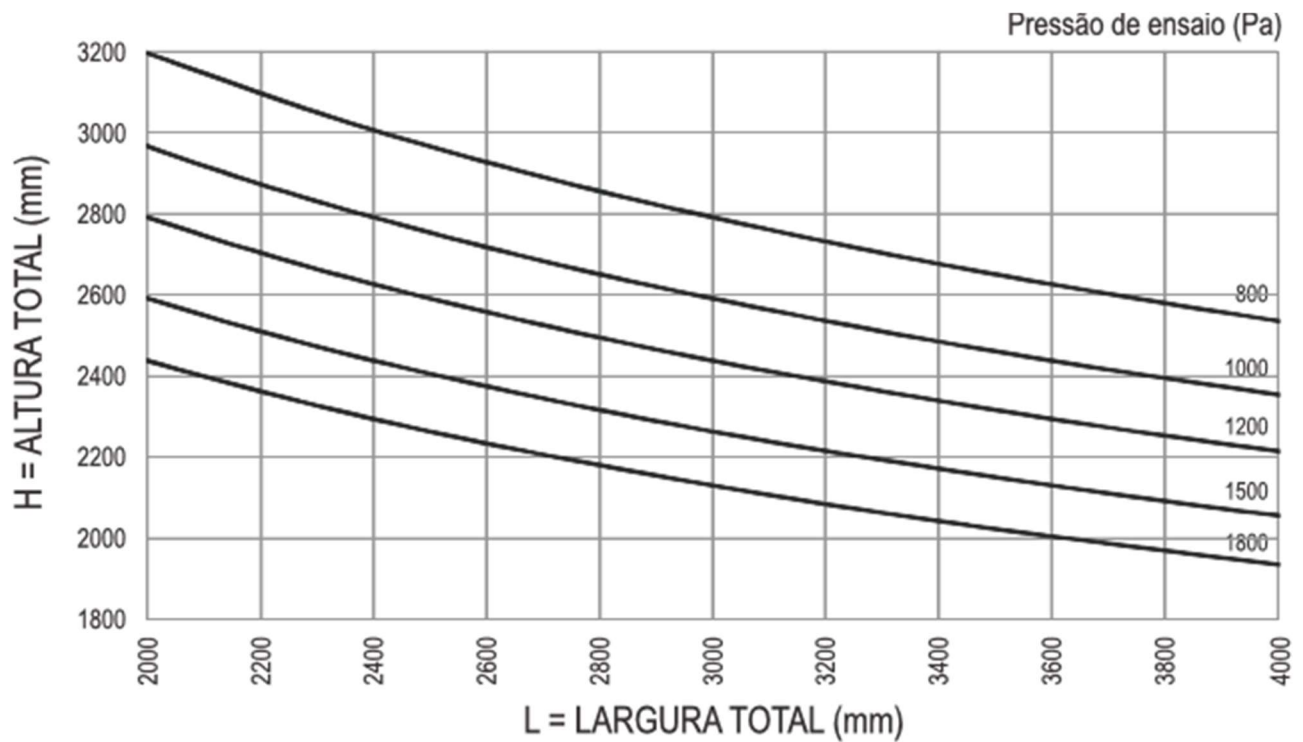



Janela Maxim-ar 01 folha

ELEVAÇÃO VISTA EXTERNA

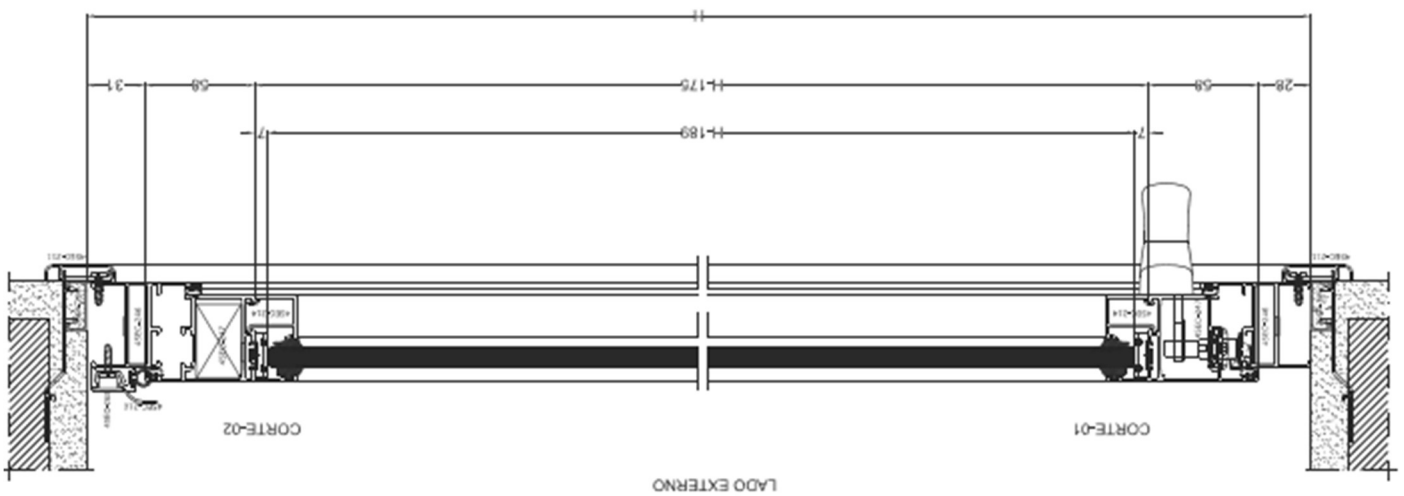
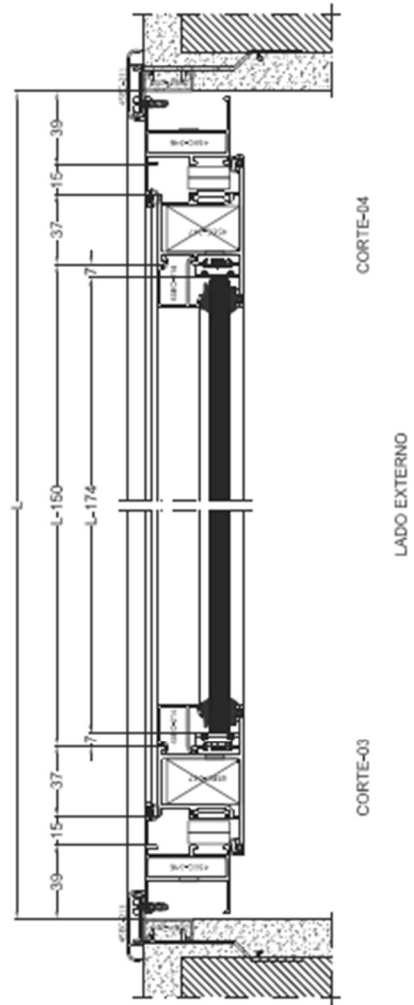
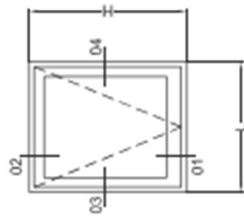

Janela de Oscilobatente 01 folha

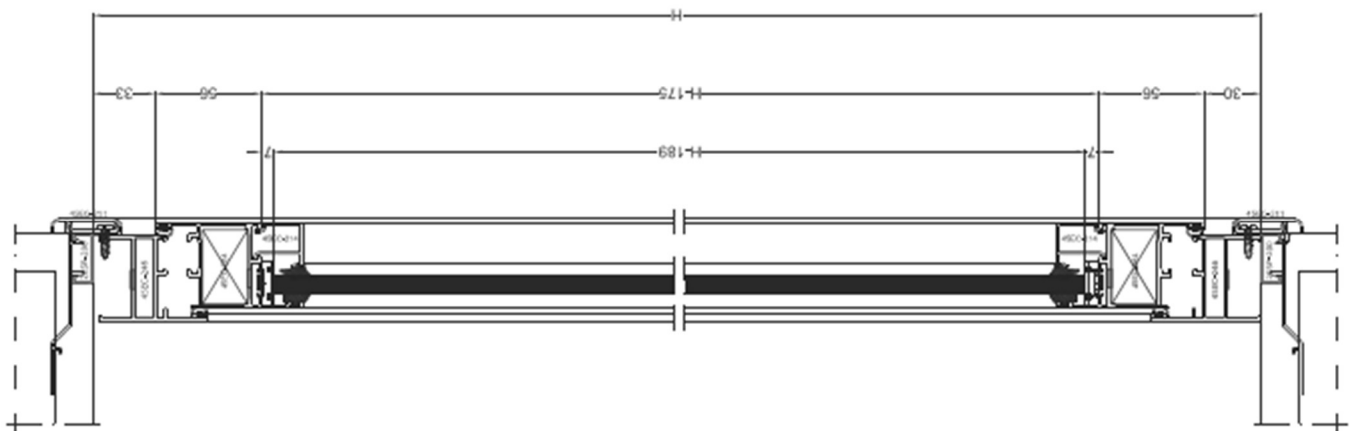
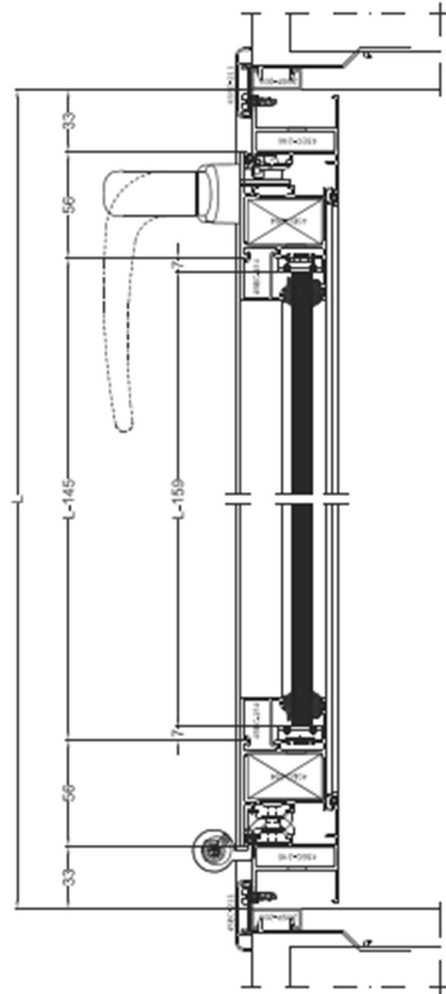
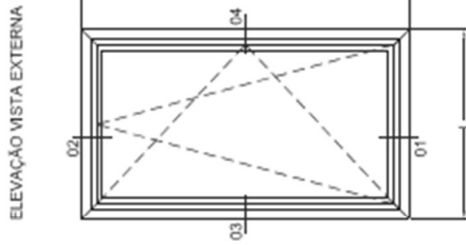

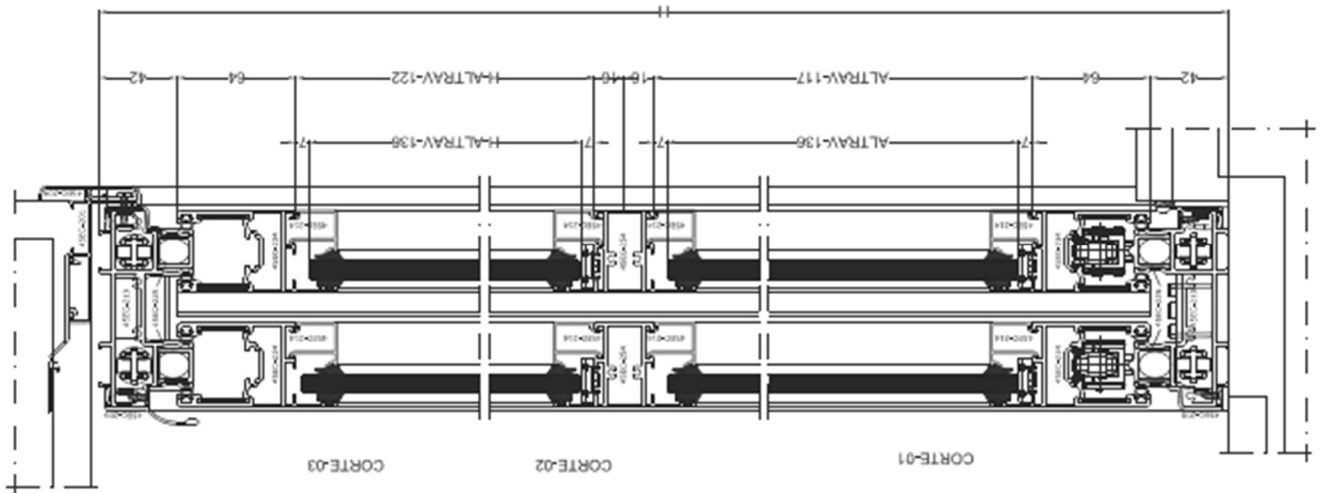
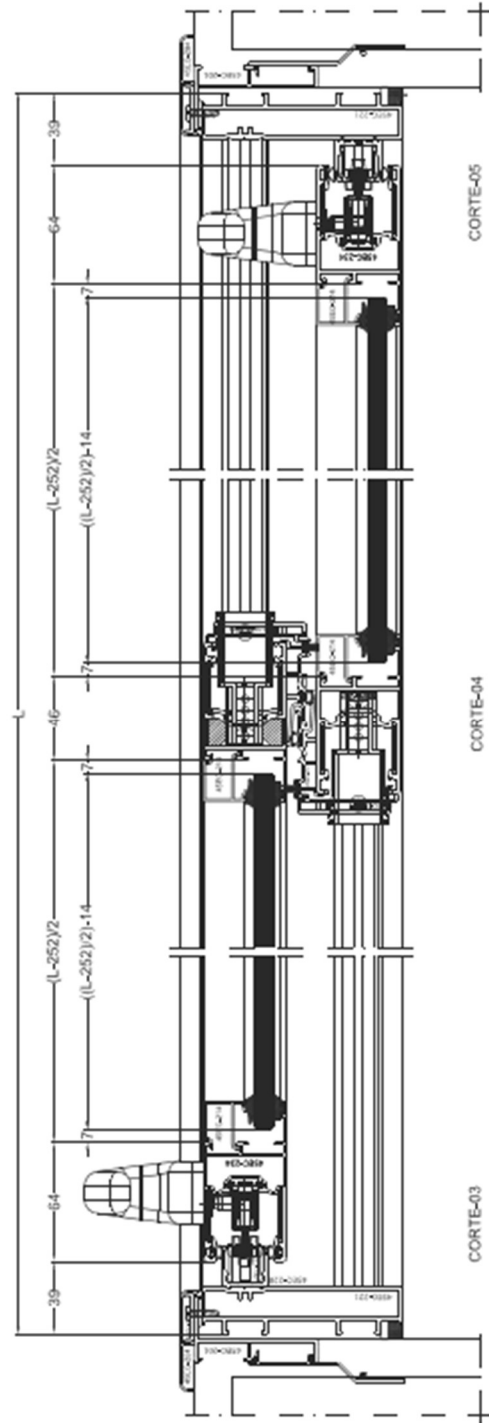
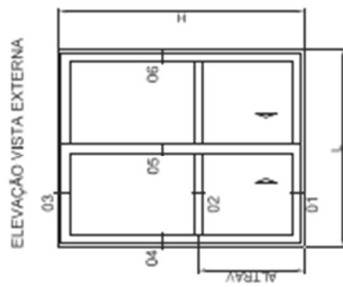

Porta de Correr 02 Folhas com Travessa

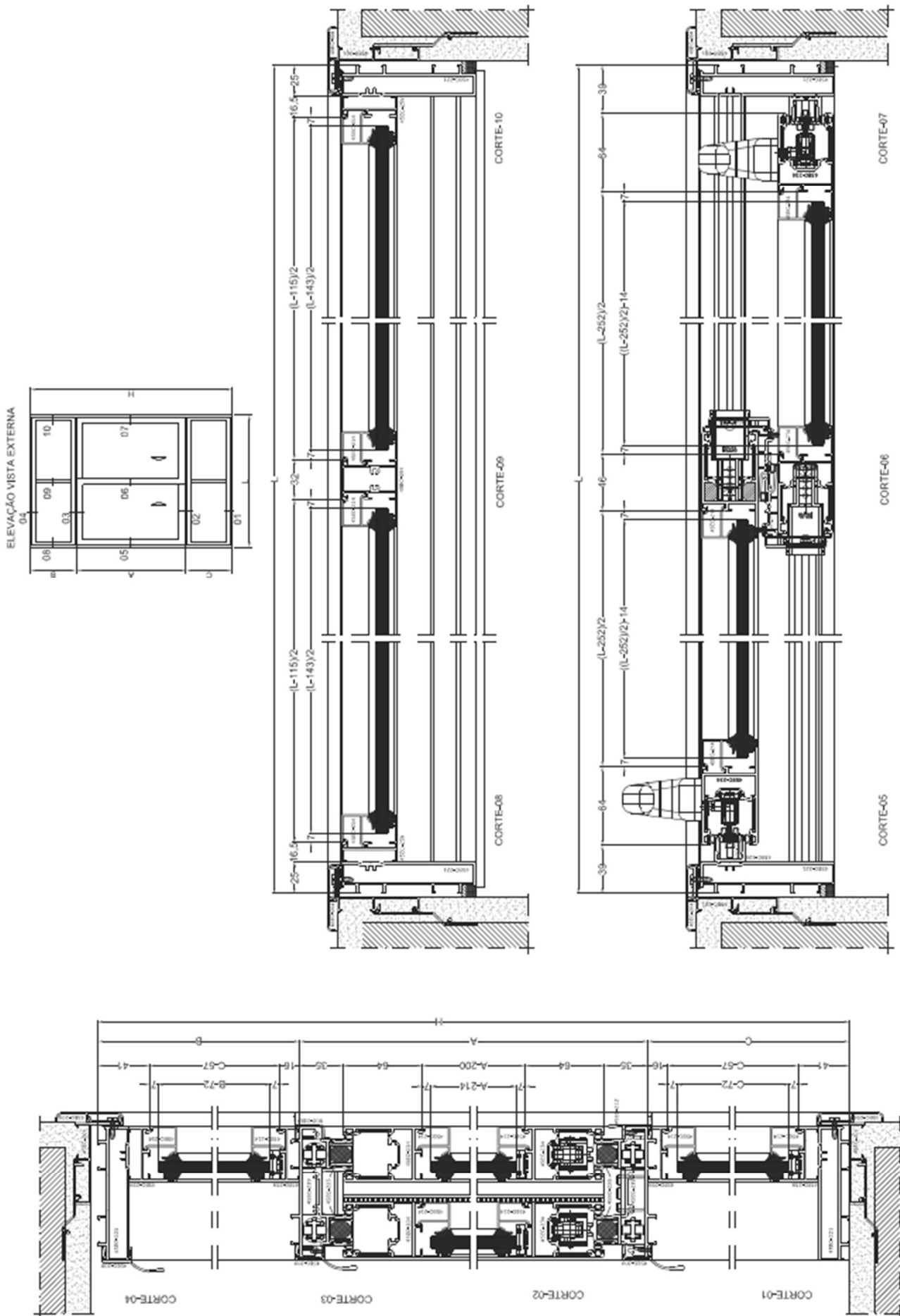

Janela de Correr 02 Folhas com Bandeira e Peitoril



aluminorte		INFORMATIVO DE SISTEMAS ALUMINORTE				SP-EURO45		
TIPOLOGIA	CROQUI	NBR 10.821 / 2017			NBR. 15575 / 2021			
		RESISTENCIA	ESTANQUEIDADE	DIMENSÕES	ANO	ACÚSTICA	DIMENSÕES	ANO
Porta Integrada 02 folhas com travessa		Região IV - (30 pav = 90m)	300Pa	1595 x 2390		38dB		
Porta Integrada 02 folhas com travessa						31dB	1500 x 2300 ESTIMATIVA	
Porta Integrada 02 folhas com travessa						38dB	1500 x 2300 ESTIMATIVA	

Obrigado,

Desde 1986  
**aluminorte**  
alumínio e acessórios

Conheça os nossos  
**sistemas no site:**  
Acesse o qr code e confira!



Nos acompanhe nas  
**redes sociais** e fique  
por dentro!  
@aluminorte

Ou entre em contato pelo telefone:  
22814822