

Desde 1986
aluminorte
alumínio e acessórios

Soluções para
alumínio desde
1986

SP | GRID [®]
FACHADA

Sistema
Aluminorte
Catálogo completo

VERSÃO V – Dezembro 2023

SP | GRID

FACHADA

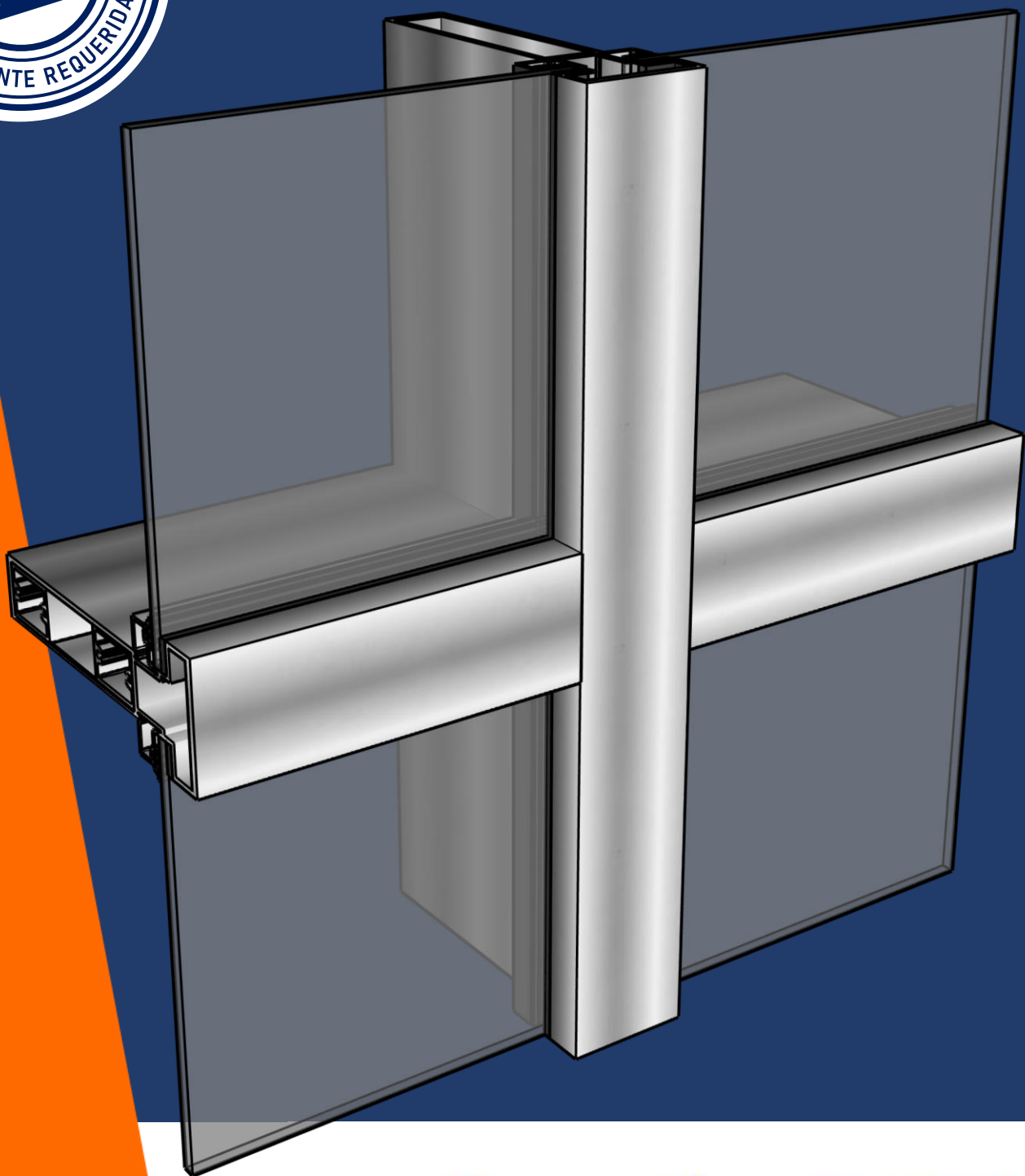

INPI INSTITUTO NACIONAL DA PROPRIEDADE INDUSTRIAL

Desde 1986
aluminorte
alumínio e acessórios

Edifício Valente
Rua Capote Valente, Pinheiros – São Paulo

Arquitetura FGMF
Idea Zarvos
Esquadrias ABA

Sistema Aluminorte

Sistemas utilizados:

SP | GRID
FACHADA
SP | ISIS

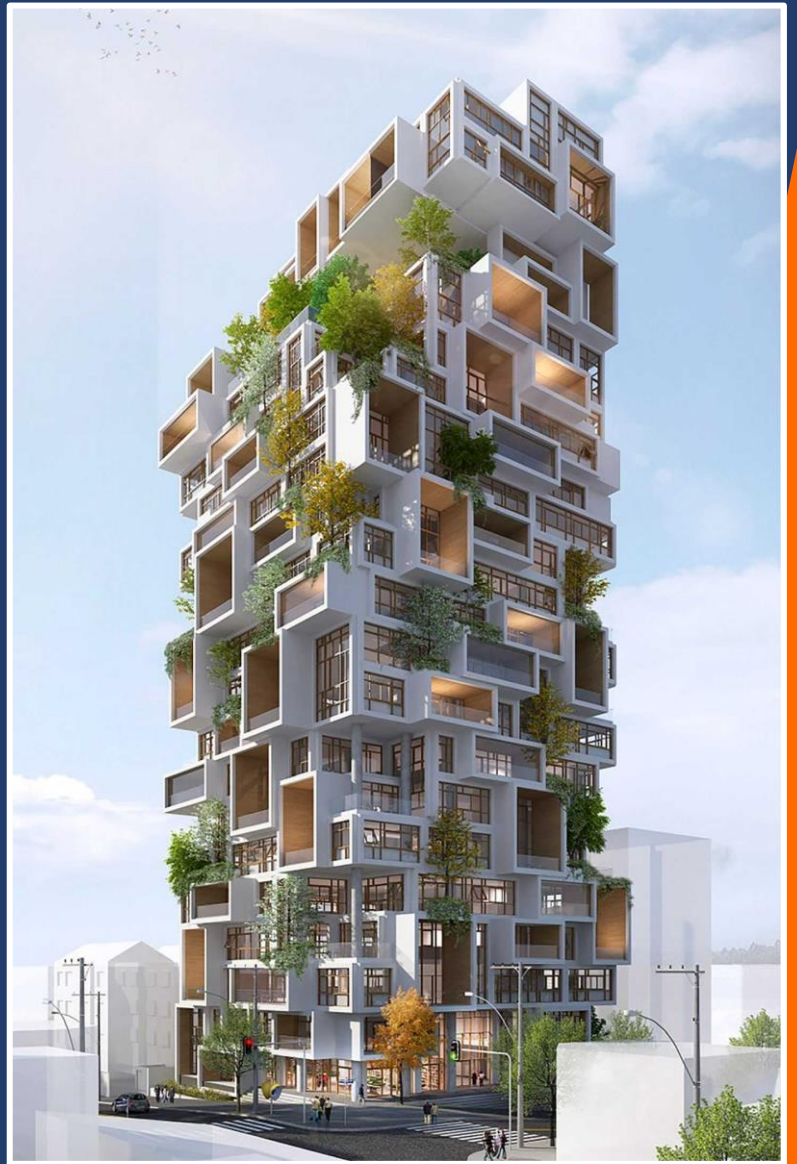

ÍNDICE DE PERFIS	01
PERFIS	02
COMPONENTES	07
PROJETOS ORIENTATIVOS	12



ÍNDICE DE PERFIS

	CÓDIGO	DESCRIÇÃO	PESO	PÁG	
	BG-057	Baguete	0,167 kg/m	06	
	LG-015	Baguete	0,147 kg/m	06	
	LG-026	Baguete	0,158 kg/m	06	
	LG-059	Baguete	0,170 kg/m	06	
	LG-085	Folha	0,529 kg/m	05	
	SPG-003	Marco Glazing	0,543 kg/m	04	
	SPG-004	Folha Glazing	0,250 kg/m	05	
	SPG-005	Coluna e Travessa	2,912 kg/m	02	
	SPG-006	Coluna e Travessa	2,221 kg/m	03	
	SPG-007	Marco	0,455 kg/m	04	
	SPG-008	Tubo Fixador	0,228 kg/m	05	

SPG-005

Coluna e Travessa
2,912 Kg/m

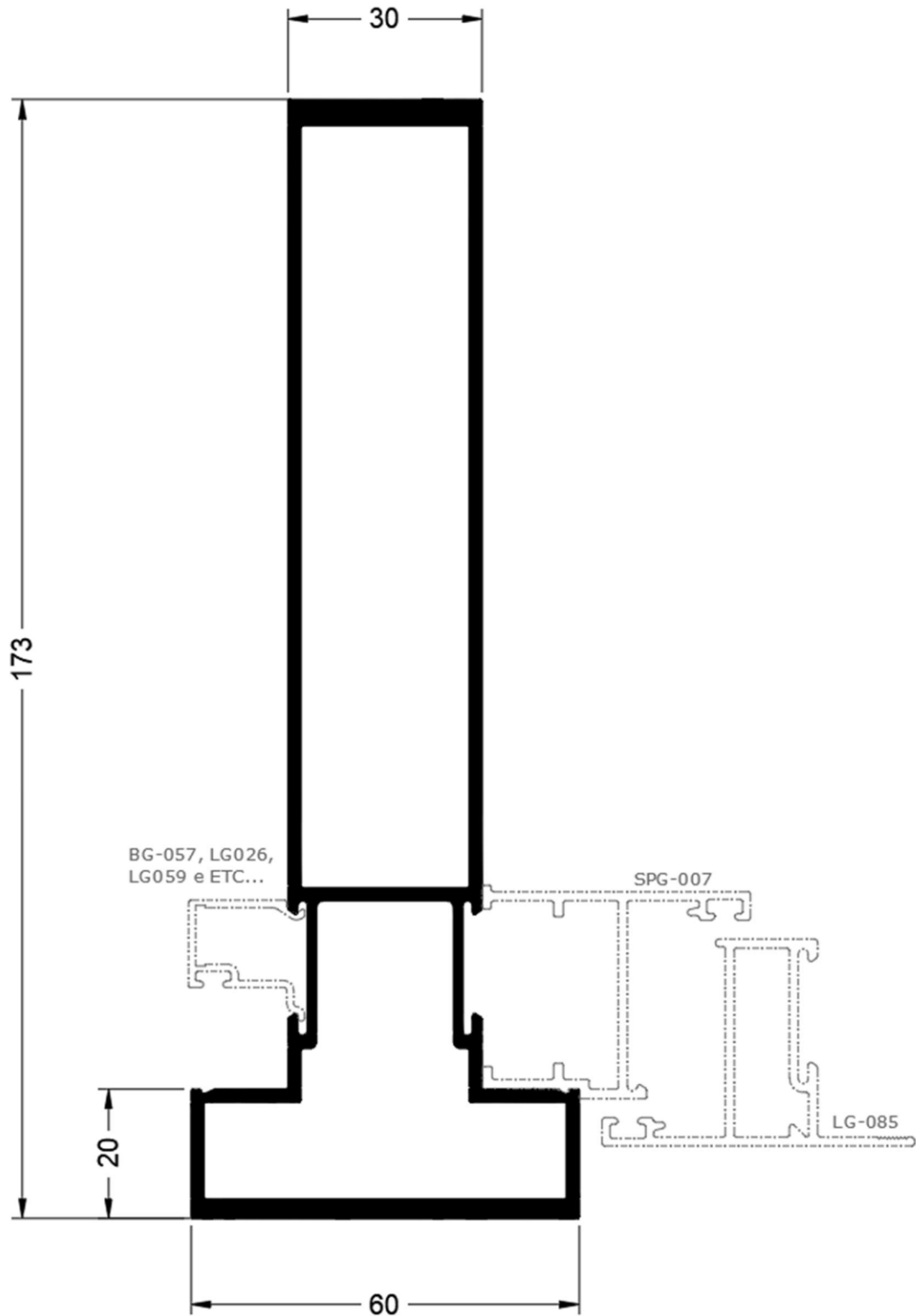
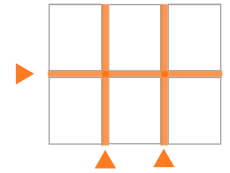

$J_x = 390.972 \text{ cm}^4$	$W_x = 40.223 \text{ cm}^3$
$J_y = 26.073 \text{ cm}^4$	$W_y = 8.691 \text{ cm}^3$

*dimensões em milímetros

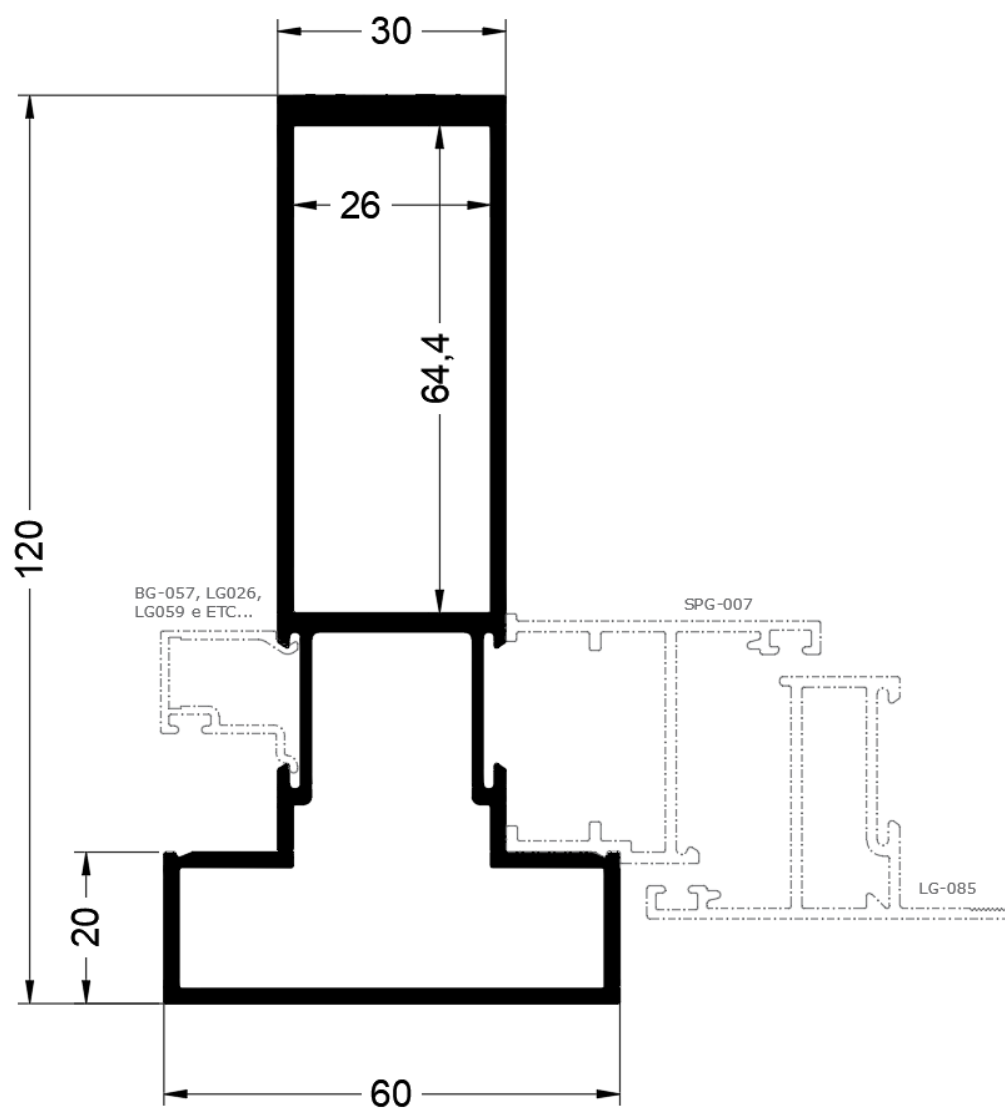
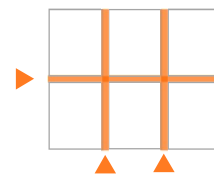
SPG-006Coluna e Travessa
2,221 Kg/m

$J_x = 141,0403 \text{ cm}^4$	$W_x = 21,833 \text{ cm}^3$
$J_y = 20,521 \text{ cm}^4$	$W_y = 6,840 \text{ cm}^3$

*dimensões em milímetros

SPG-007

Marco
0,445 Kg/m

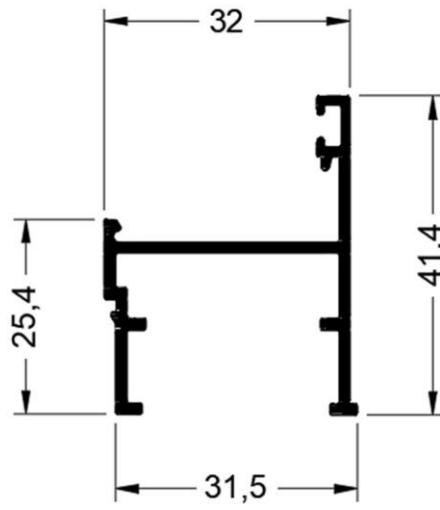
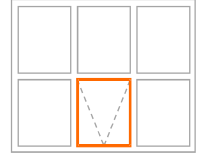

SPG-003

Marco Glazing
0,543 Kg/m

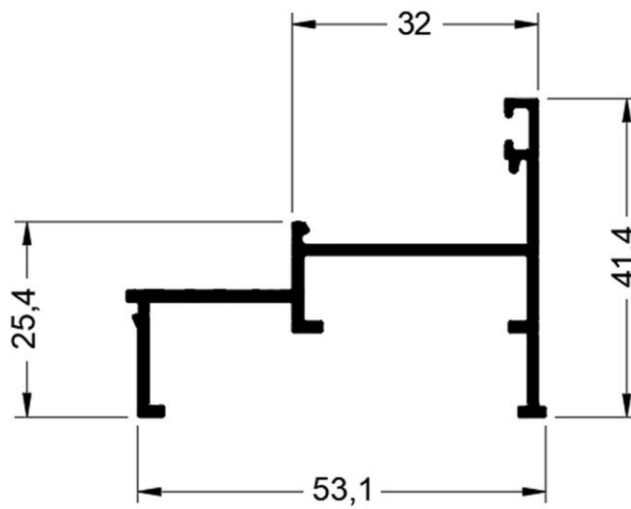
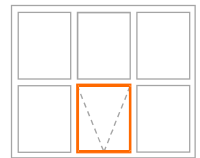

LG-085

Folha
0,529 Kg/m

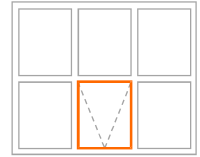
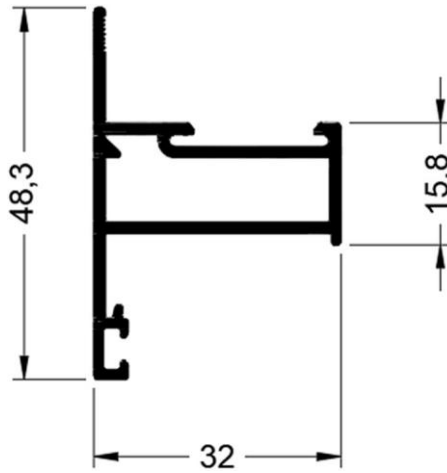

SPG-004

Folha Glazing
0,250 Kg/m

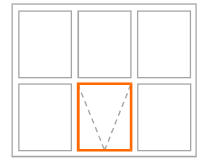
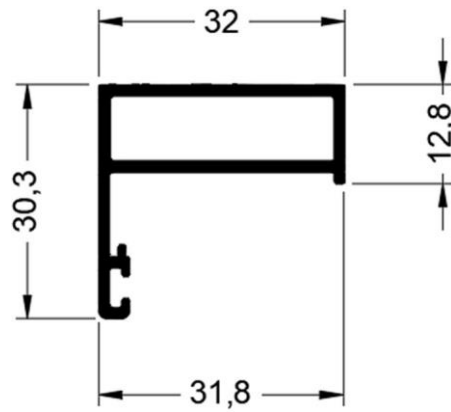

SPG-008

Fixador De Travessa
0,228 Kg/m

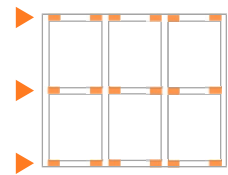
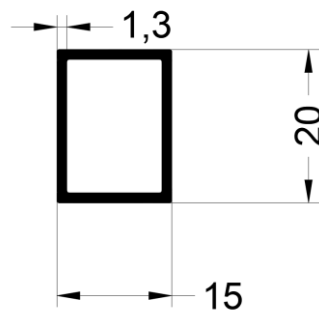

BG-057

Baguete
0,167 Kg/m

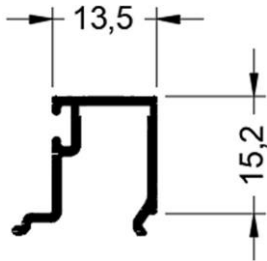
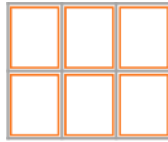

LG-059

Baguete
0,170 Kg/m

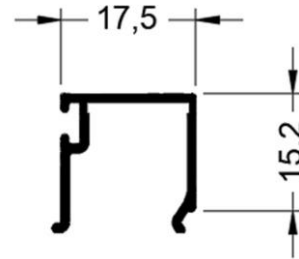
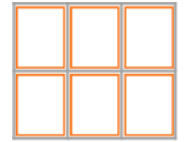

LG-026

Baguete
0,158 Kg/m

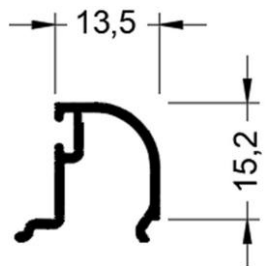
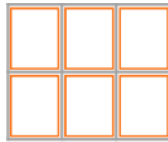

LG-015

Baguete
0,147 Kg/m

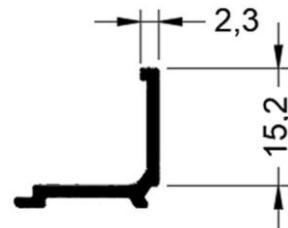
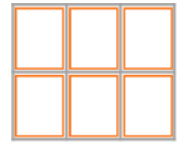

*dimensões em milímetros

COMPONENTES

ACESSÓRIO	CÓDIGO	DESCRIÇÃO
	BRAUDMAX 17PD	Braço Projetante (Pág. 8)
	CHUPRP380AINX	Chumbador Expansivo com Prolongador 3/8" x 110 mm – aço Inox
	CHUPFP3802INX	Chumbador Expansivo com prolongador 3/8" x 114 mm – aço inox
	GUA239	Guarnição do Marco EPDM Preto (Pág. 07)
	GUA259	Guarnição do Vidro EPDM Preto (Pág. 07)
	GUA 304	Guarnição Adesiva Esponjosa 14 mm x 6,4 mm – Preta (Pág.07)
	GUA306	Guarnição Adesiva Esponjosa 14 mm x 4,8 mm – Preta (Pág.07)
	FECHO 6735D	Fecho Maxim-ar 6735dD Gold c/ CCTF B7 – Udinese (Pág.09)
	FECHO 735D	Fecho Maxim-ar 735D Gold c/ CCTF B7 – Udinese (Pág.10)
	PAR4213	Parafuso AA Ø 4,2 x 13 mm
	PAR4216	Parafuso AA Ø 4,2 x 13 mm (auto brocante)
	PAR4219	Parafuso AA Ø 4,2 x 19 mm

LG-085

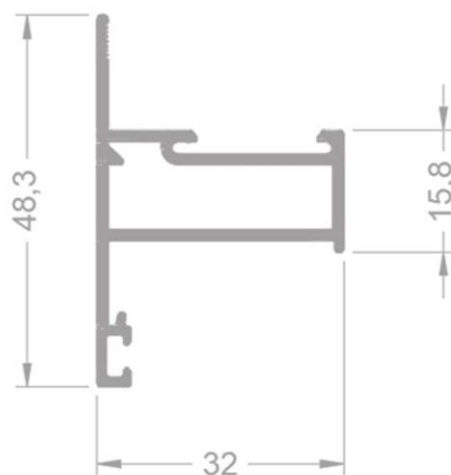

DETALHES		Espessura Vidro (mm)	Guarnição Interna	Guarnição Externa
BG-057 ou LG-056		8	GUA259	GUA304
		10	GUA259	GUA306
LG-027		18	GUA259	GUA306
LG-015		22	GUA259	GUA306

*dimensões em milímetros

VERSÃO	COR	CÓDIGO UDINESE	CÓDIGO UNIVERSAL	LARGURA MÁX. DA FOLHA (mm)	ALTURA MÁX. DA FOLHA (mm)	CARGA MÁX. (kg)
350	BCO	9103129	BRAUDMAX17PD350BCO	1500	600	22
	PRE	9103132	BRAUDMAX17PD350PTF			
600	BCO	9103134	BRAUDMAX17PD600BCO	1500	1000	35
	PRE	9103137	BRAUDMAX17PD600PTF			
950	BCO	9103139	BRAUDMAX17PD950BCO	1500	1200	42
	PRE	9103142	BRAUDMAX17PD950PTF			
1200	BCO	9103144	BRAUDMAX17PD12000BCO	1500	1500	74
	PRE	9103147	BRAUDMAX17PD12000PTF			

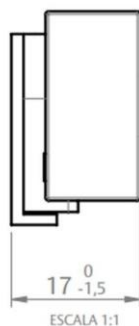
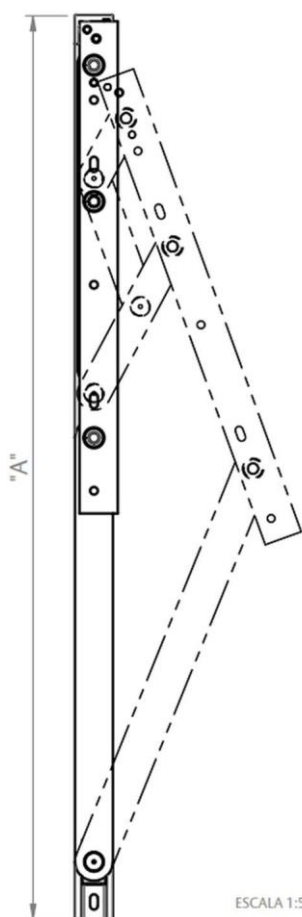

APLICAÇÃO

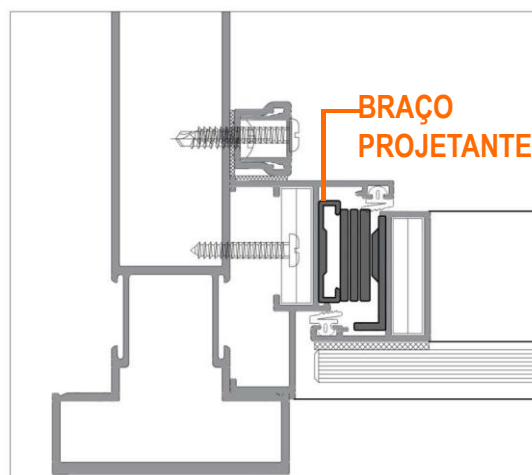

FECHO MAX-AR 6735D GOLD C/ CCTF B7



UDINESE
ASSA ABLOY

POSIÇÃO	COR	CÓDIGO	CÓDIGO CATÁLOGO
DIREITO	BCO	9210735	FEC6735DGB7BCO
	PRA	9210736	FEC6735DGB7PRA
	PTF	9210737	FEC6735DGB7PTF
ESQUERDO	BCO	9210738	FEC6735EGB7BCO
	PRA	9210739	FEC6735EGB7PRA
	PTF	9210740	FEC6735EGB7PTF

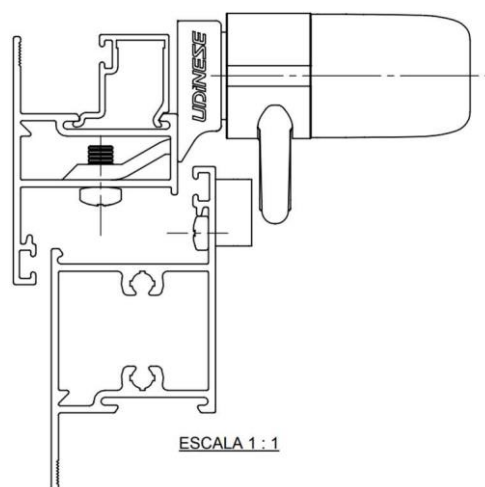
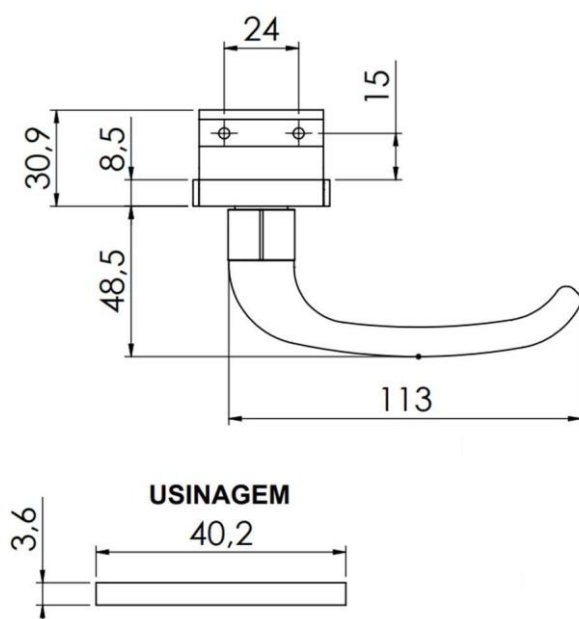

FECHO MAX-AR 735D GOLD C/ CTF B7

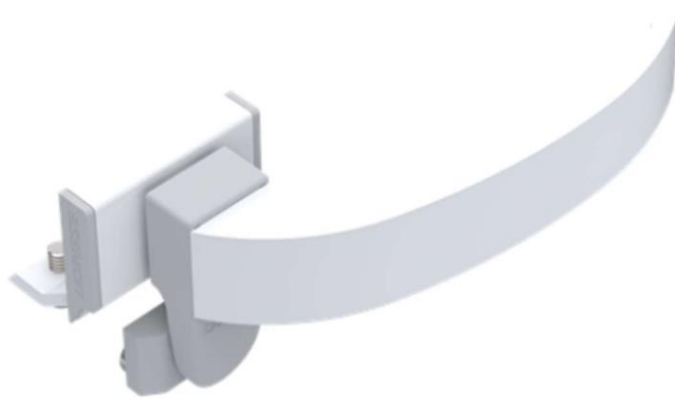

UDINESE
ASSA ABLOY

POSIÇÃO	COR	CÓDIGO	CÓDIGO CATÁLOGO
DIREITO	BCO	9210735	FEC735DGOLDBCO
	PRA	9210736	FEC735DGOLDPRA
	PTF	9209334	FEC735DGOLDPTF
ESQUERDO	BCO	9206789	FEC735EGOLDBCO
	PRA	9209657	FEC735EGOLDPRA
	PTF	9209362	FEC735EGOLDPTF

INSTRUÇÃO DE MONTAGEM E USINAGEM

IMAGEM MERAMENTE ILUSTRATIVA

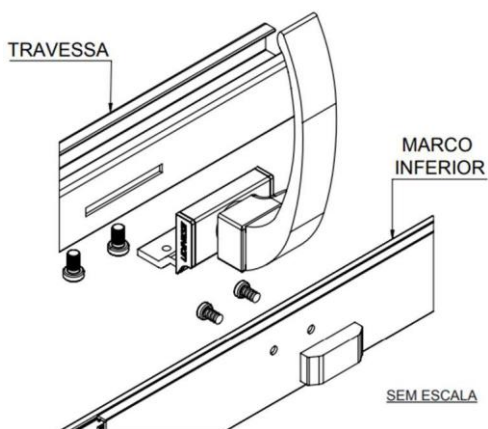

USINAGEM DA TRAVESSA

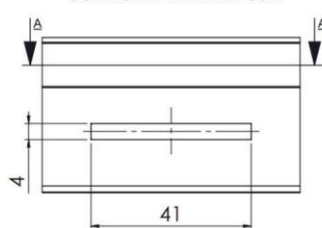

SEÇÃO A-A

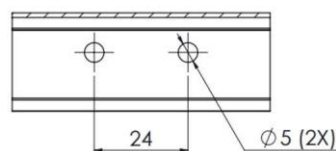

REFERÊNCIA DE USINAGEM

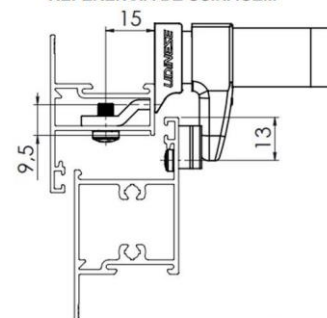

USINAGEM DO MARCO INFERIOR

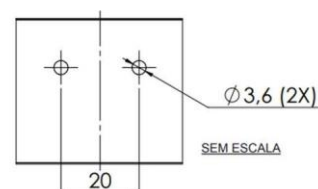

DIMENSÕES

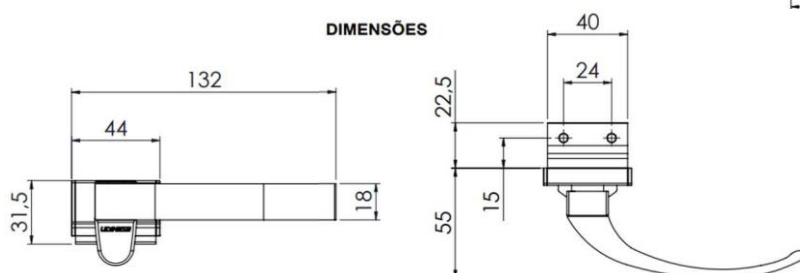

Fachada Simples "n" módulos

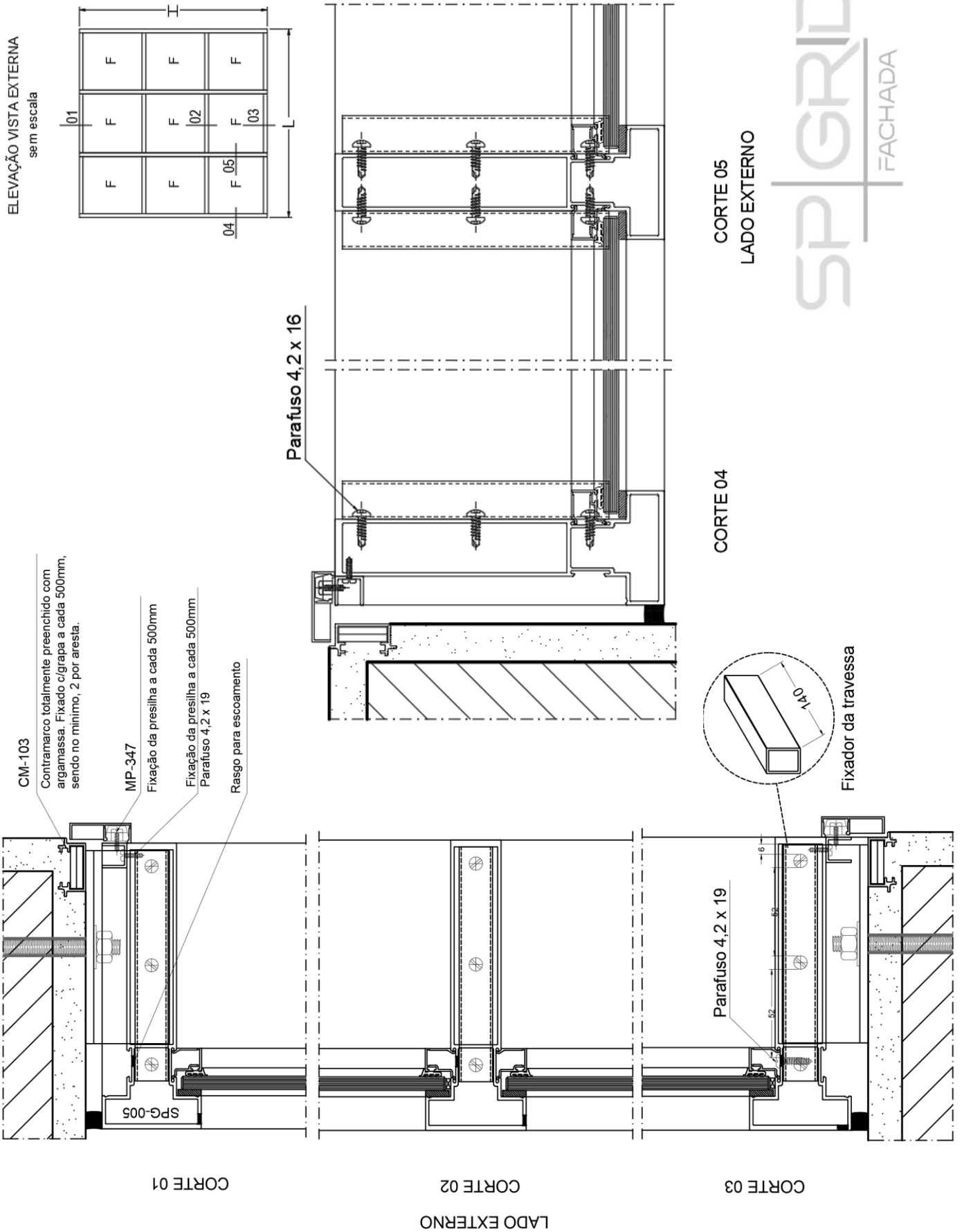

Fachada Simples com maxim-ar inferior com baguete

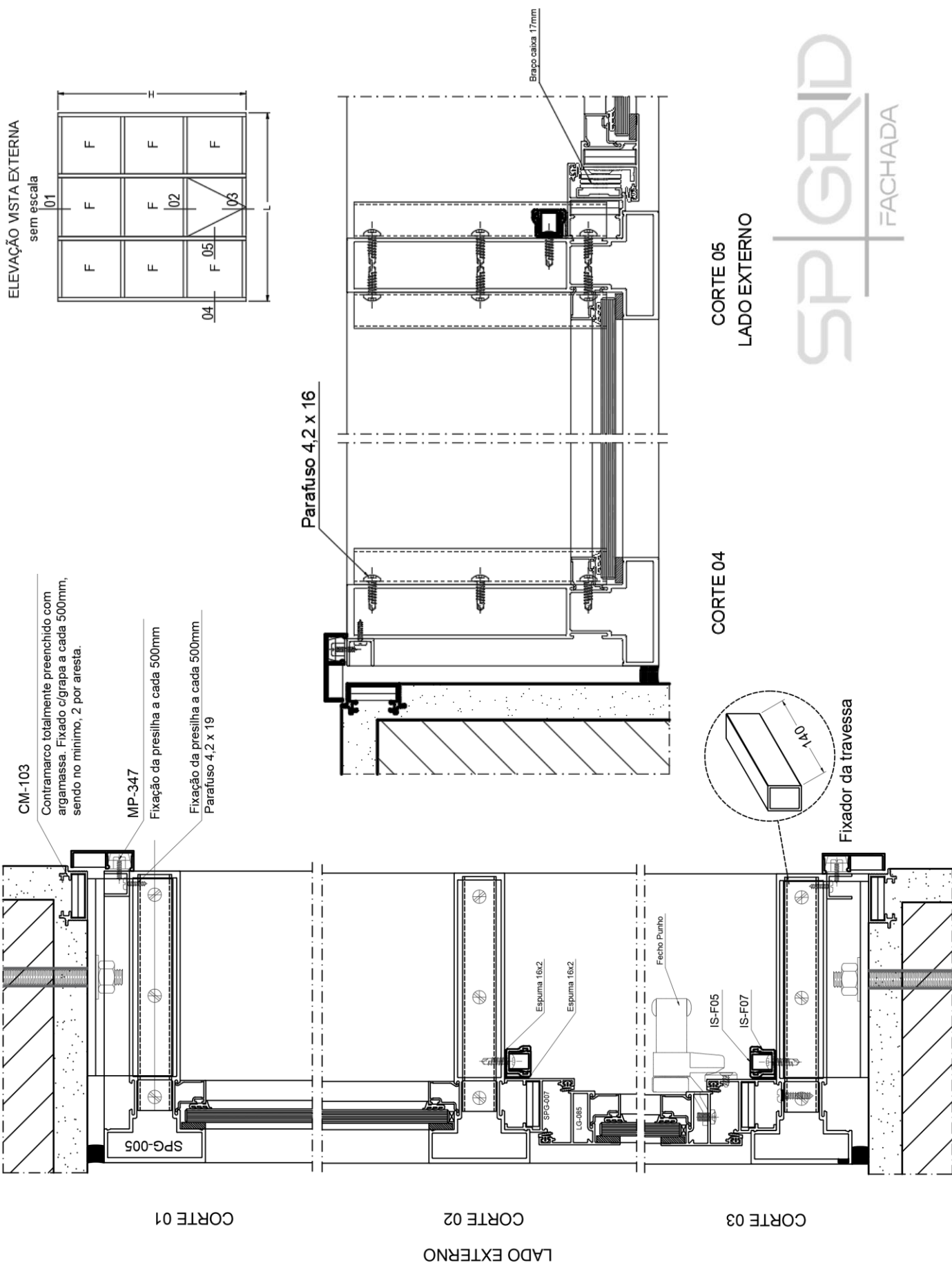

Fachada Simples com maxim-ar inferior com vidro colado sem baguete

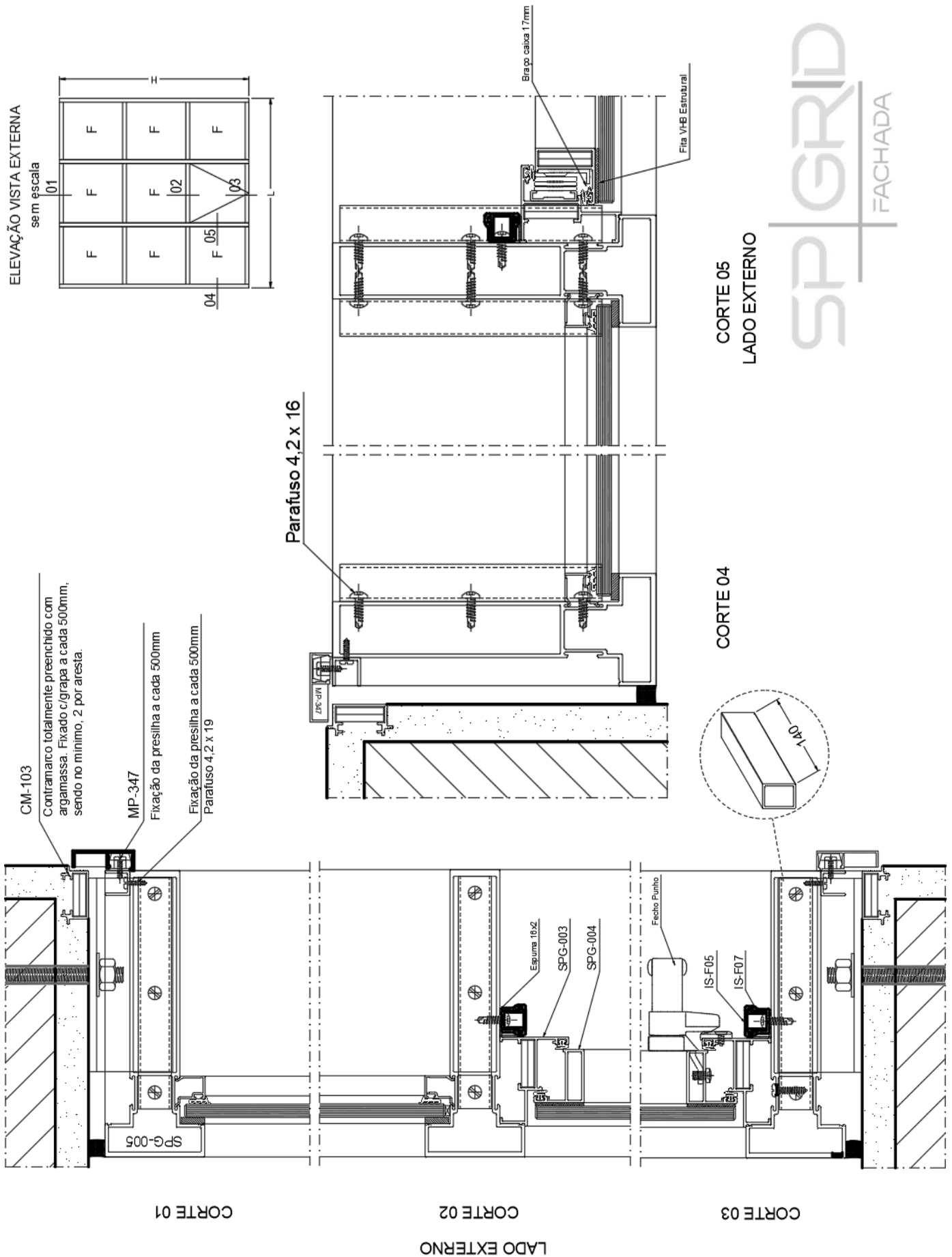

Obrigado,

Desde 1986
aluminorte
alumínio e acessórios

Conheça os nossos
sistemas no site:

Acesse o qr code e confira!



Nos acompanhe nas
redes sociais e fique
por dentro!
@aluminorte

Ou entre em contato pelo telefone:
22814822