

Desde 1986
aluminorte
alumínio e acessórios

Soluções para
alumínio desde
1986

GRADIL
SPARTA®

Sistema
Aluminorte
Cátalogo completo

VERSÃO VI - Abril 2024

GRADIL SPARTA

3 OPÇÕES DE
CORRIMÃO

+

3 OPÇÕES DE
GUARDA CORPO



SISTEMA TESTADO E
APROVADO PELO
ITEC – BNR 14.718

corrimão *inclinado*



corrimão *reto*



corrimão *curvo*

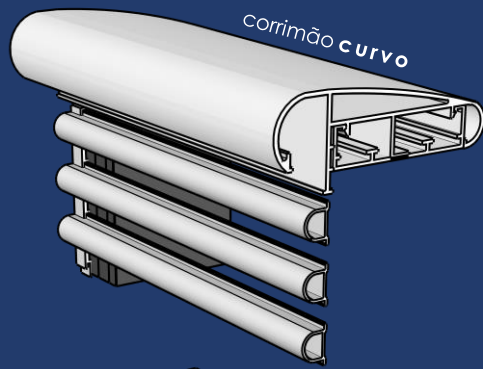

guarda corpo em
vidro

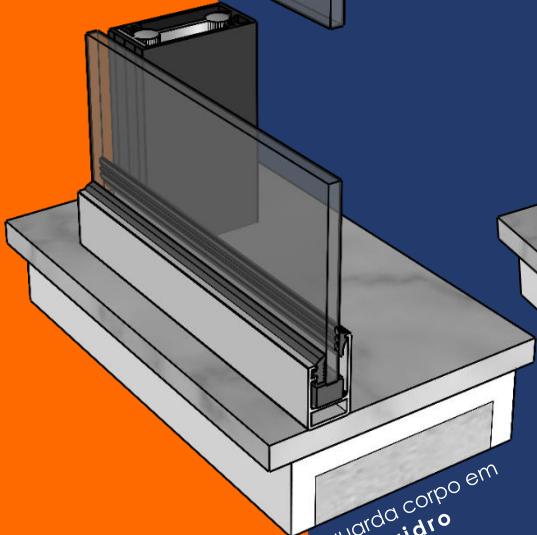

guarda corpo em
barrotes verticais

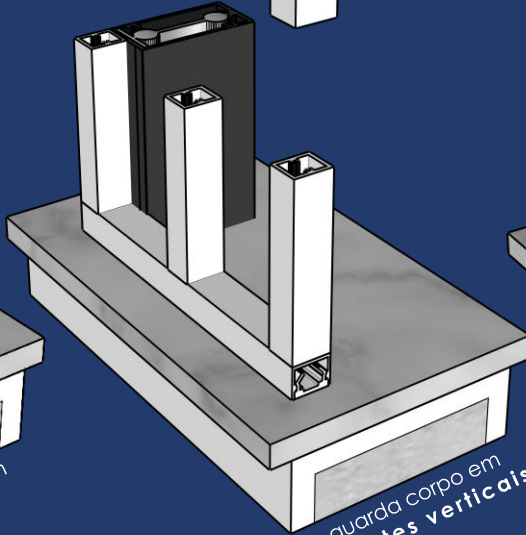

guarda corpo em
barrotes horizontais

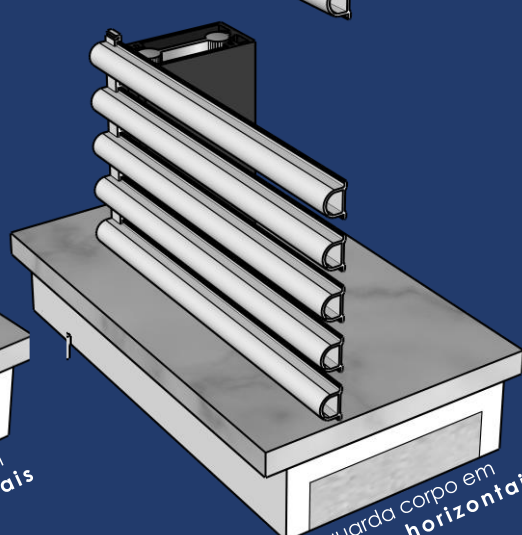

aluminorte Desde 1986
alumínio e acessórios

ÍNDICE DE PERFIS	01
PERFIS	02
PROJETOS ORIENTATIVOS	10

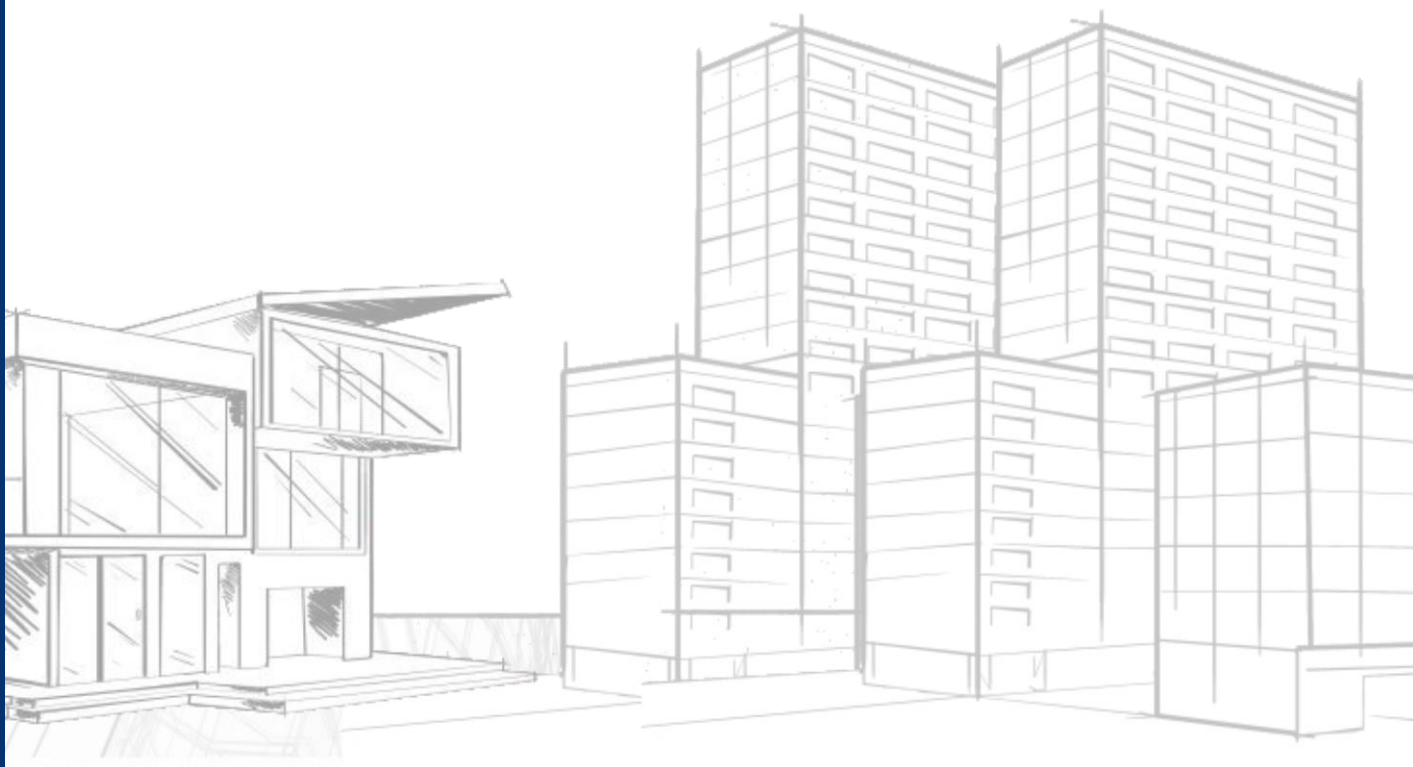

ÍNDICE DE PERFIS

	CÓDIGO	DESCRIÇÃO	PESO	PÁG	
	CG171	Suporte Vidro	0,371 Kg/m	6	
	GR001	Barrote	0,179 Kg/m	9	
	GR002	Suporte Vidro	0,572 Kg/m	6	
	GR006	Guia do Barrote	0,733 Kg/m	9	
	GR017	Coluna do Gradil	1,415 Kg/m	4	
	GR018	Luva Corrimão	0,389 Kg/m	7	
	GR019	Corrimão Curvo	1,669 Kg/m	3	
	GR020	Suporte do Corrimão	0,591 Kg/m	3	
	GR022	Pontaleta	1,445 Kg/m	6	
	GR031	Corrimão Inclinado	1,065 Kg/m	2	
	GR032	Suporte do Gradil	0,609 Kg/m	4	
	GR033	Coluna de Canto do Gradil	1,653 Kg/m	5	
	GR034	Corrimão Reto	1,031 Kg/m	2	
	GR035	Suporte do Barrote	0,253 Kg/m	8	
	GR036	Tampa Click	0,238 Kg/m	7	
	GR037	Contratampa Click	0,272 Kg/m	7	
	GR038	Barrote	0,556 Kg/m	8	
	GR039	Suporte Superior Barrote	0,253 Kg/m	8	

GR - 031

Corrimão Inclinado
1,065 Kg/m

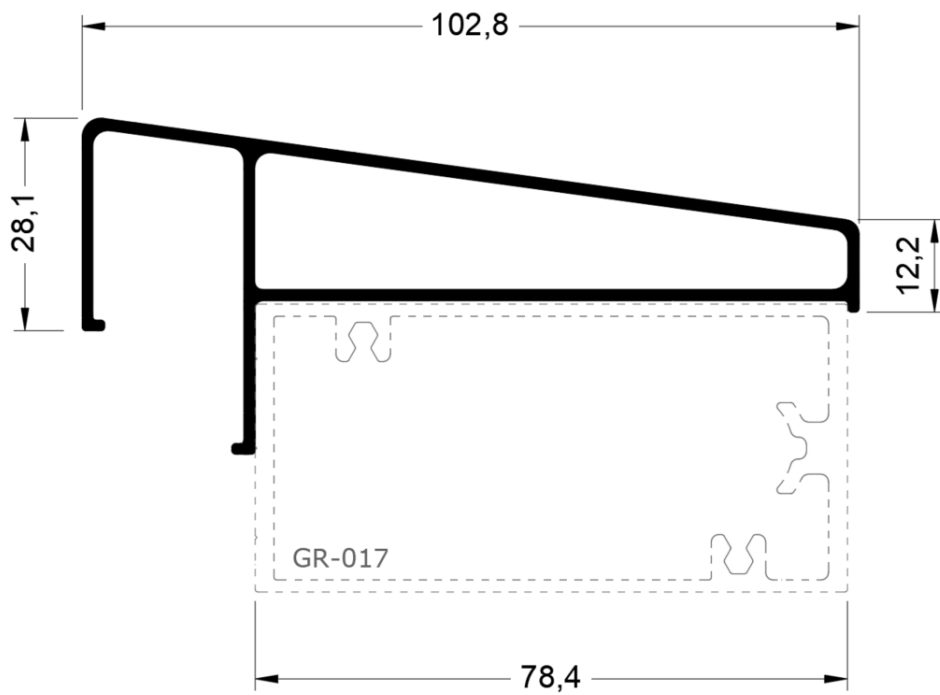
**GR - 034**

Corrimão Reto
1,031 Kg/m

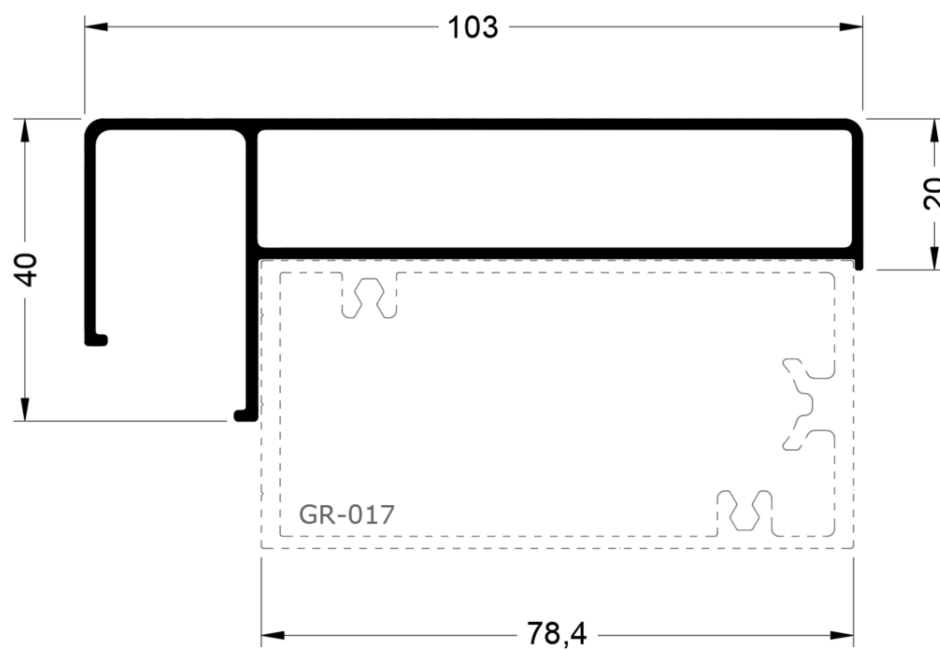

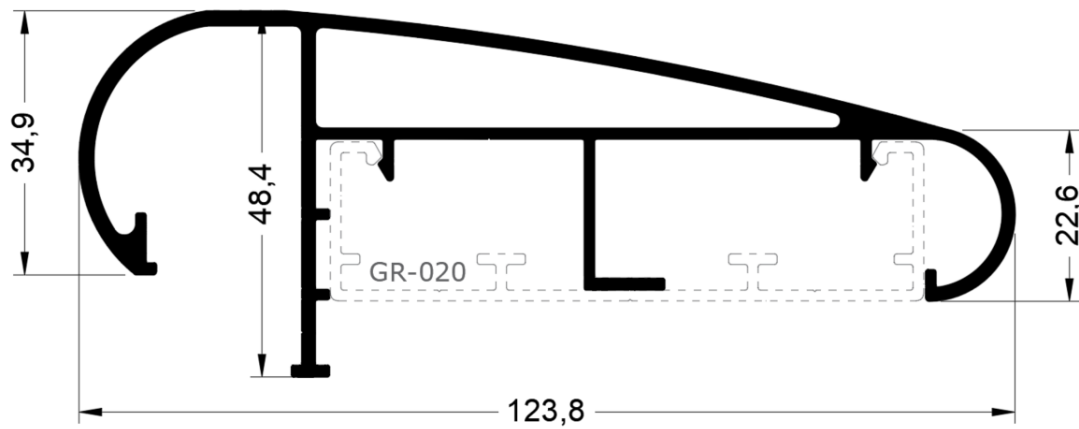
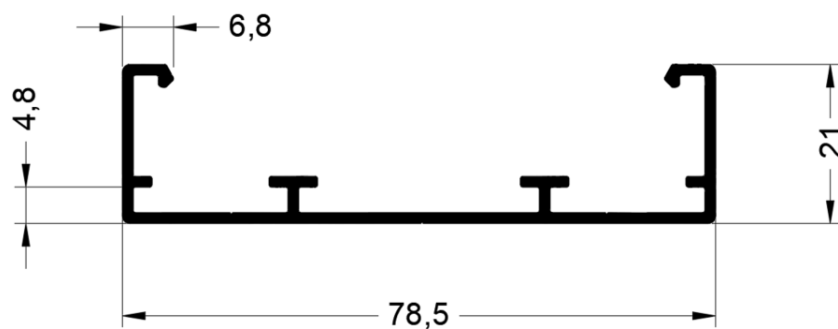
GR - 019Capa do Corrimão
1,669 Kg/m**GR - 020**Suporte da Capa
0,591 Kg/m

GR - 032

Suporte do Gradil
0,609 Kg/m

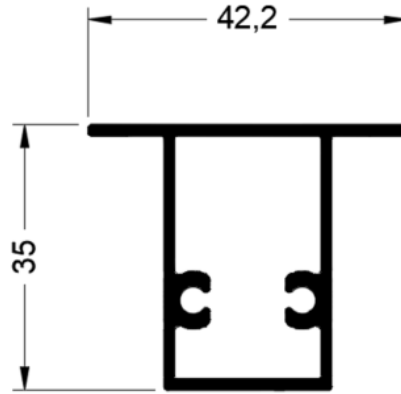
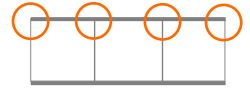

GR - 017

Coluna do Gradil
1,415 Kg/m

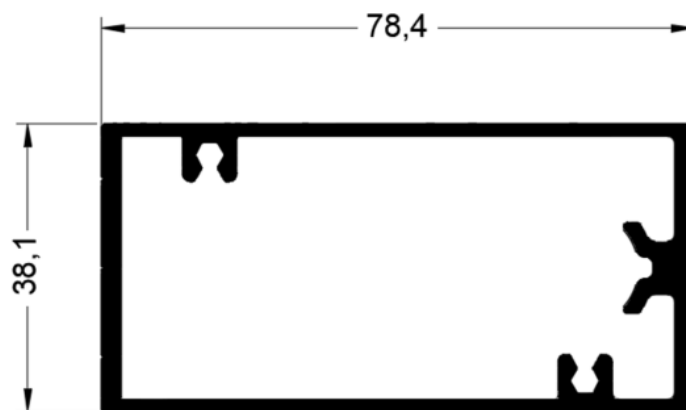
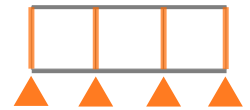

GR - 033

Coluna de Canto do Gradil
1,653 Kg/m

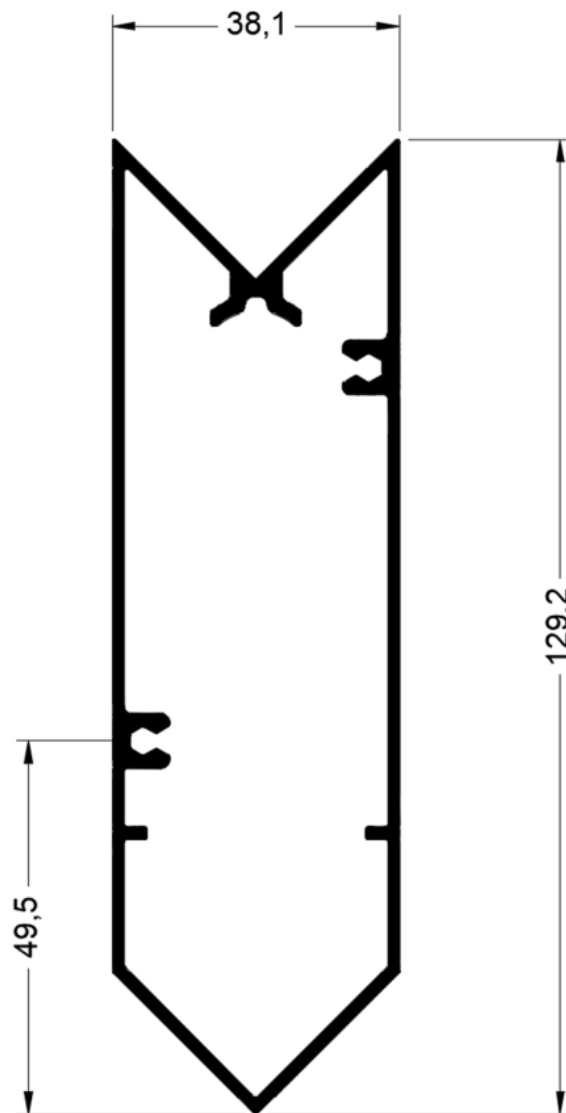
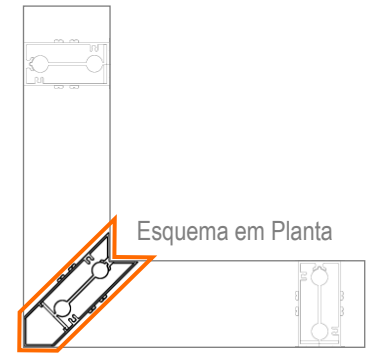

GR - 022

Pontaletes
1,445 Kg/m

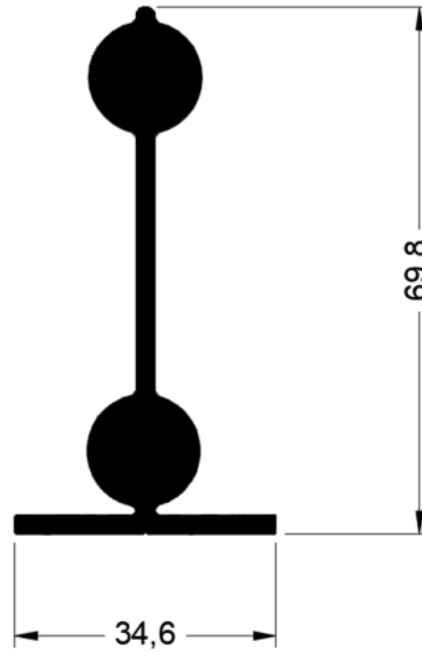
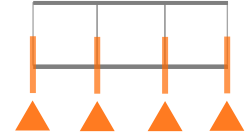

GR - 002

Suporte Vidro
0,572 Kg/m

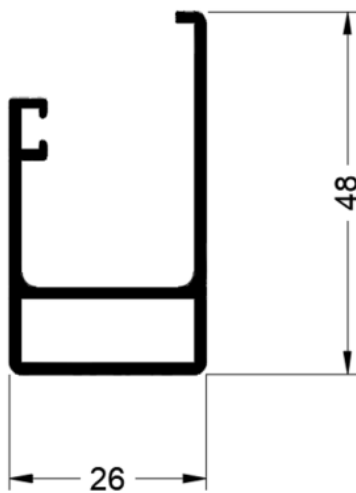
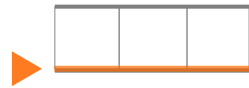

CG - 171

Suporte Vidro
0,371 Kg/m

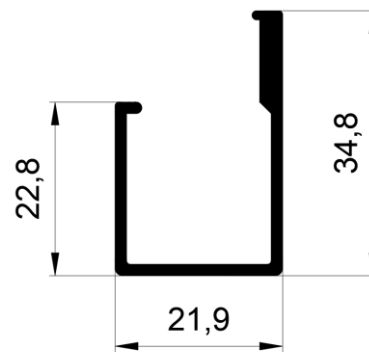

GR - 037

Contratampa Click
0,272 Kg/m

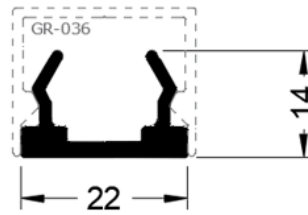
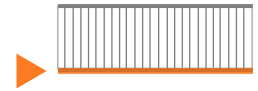
**GR - 036**

Tampa Click
0,238 Kg/m

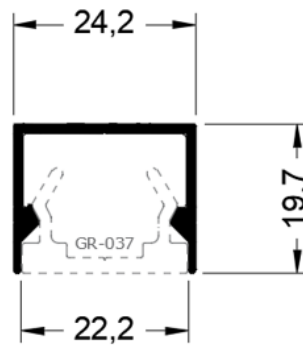
**GR - 018**

Luva do Corrimão
0,389 Kg/m

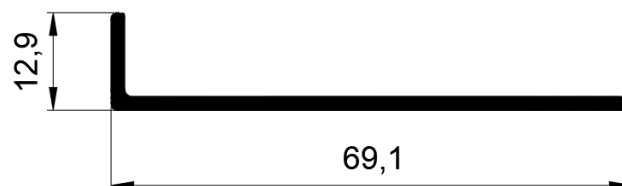

GR - 039

Suporte do Barrote
0,253 Kg/m

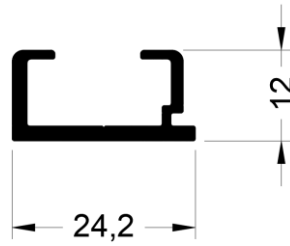

GR - 035

Suporte do Barrote Inferior
0,250 Kg/m

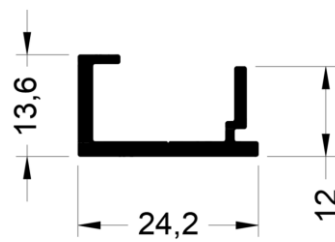
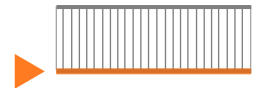

GR - 038

Barrote
0,556 Kg/m

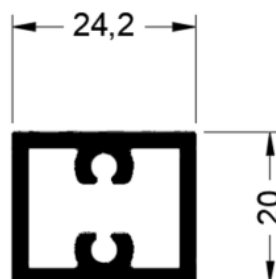

GR - 001

Barrote
0,179 Kg/m

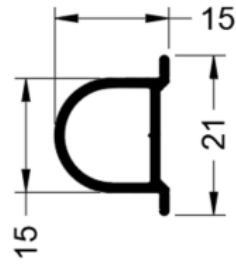
**GR - 006**

Guia do Barrote
0,733 Kg/m

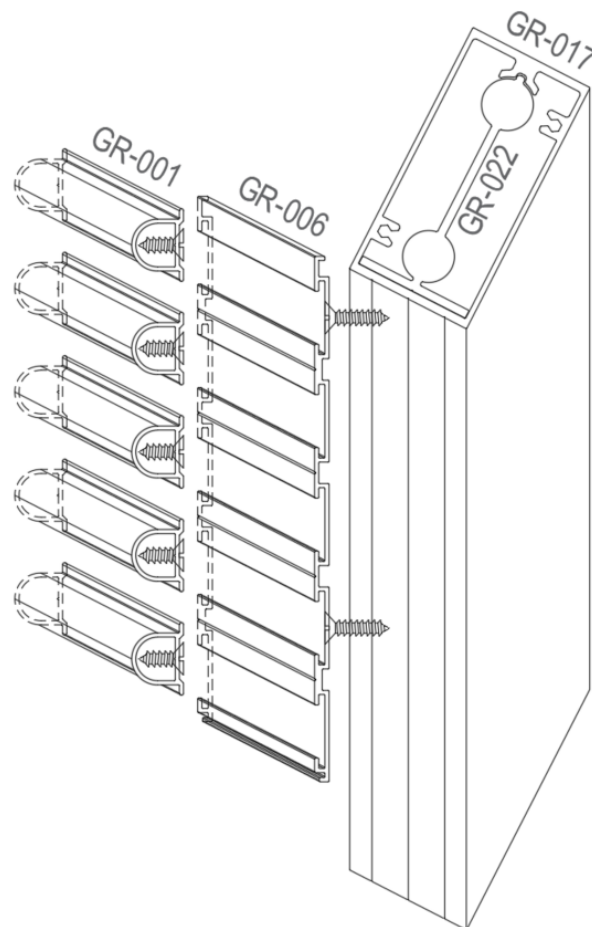
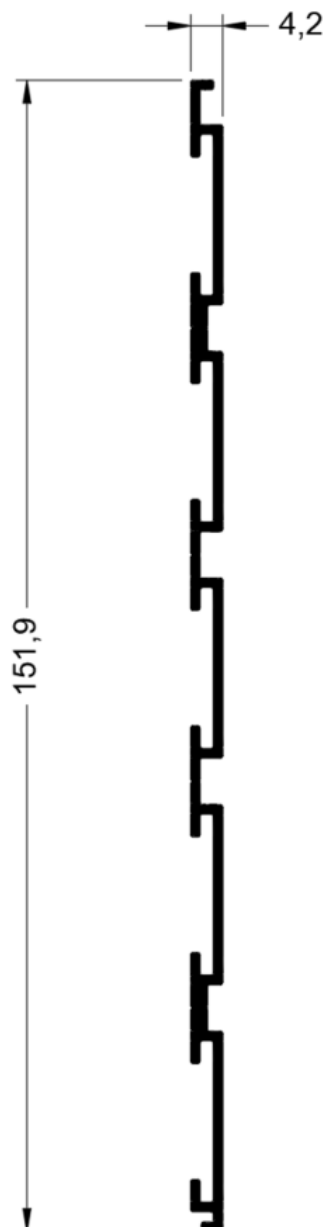
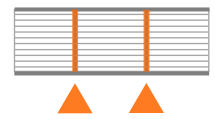

Esquema de montagem em 3D - fora de escala
(detalhes na pág. 15)

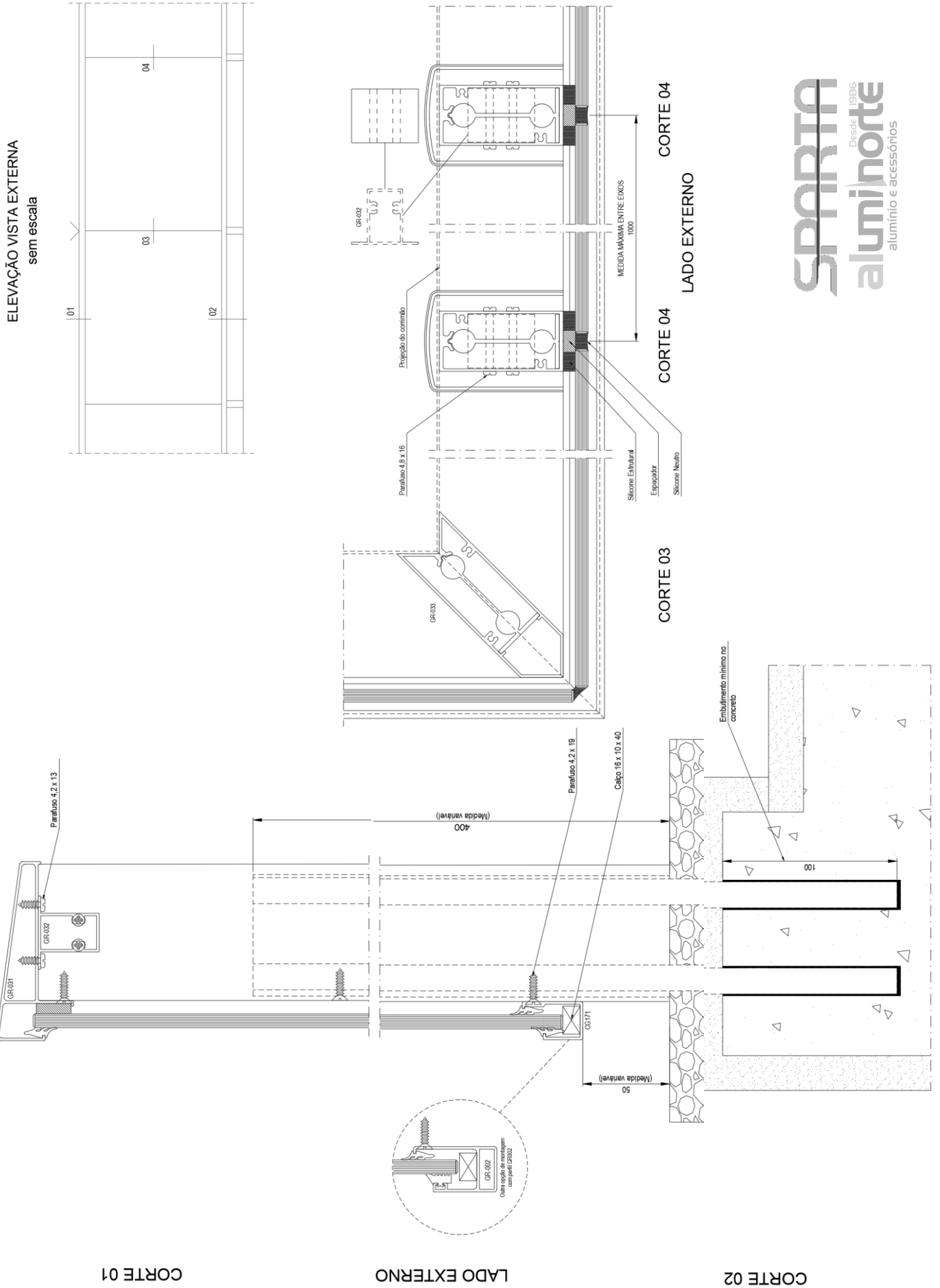

SPARTA
Desde 1986
aluminorte
alumínio e acessórios

*dimensões em milímetros

PROJETOS ORIENTATIVOS

GUARDA CORPO COM CORRIMÃO RETO E VIDRO COM COLUNA DE CANTO

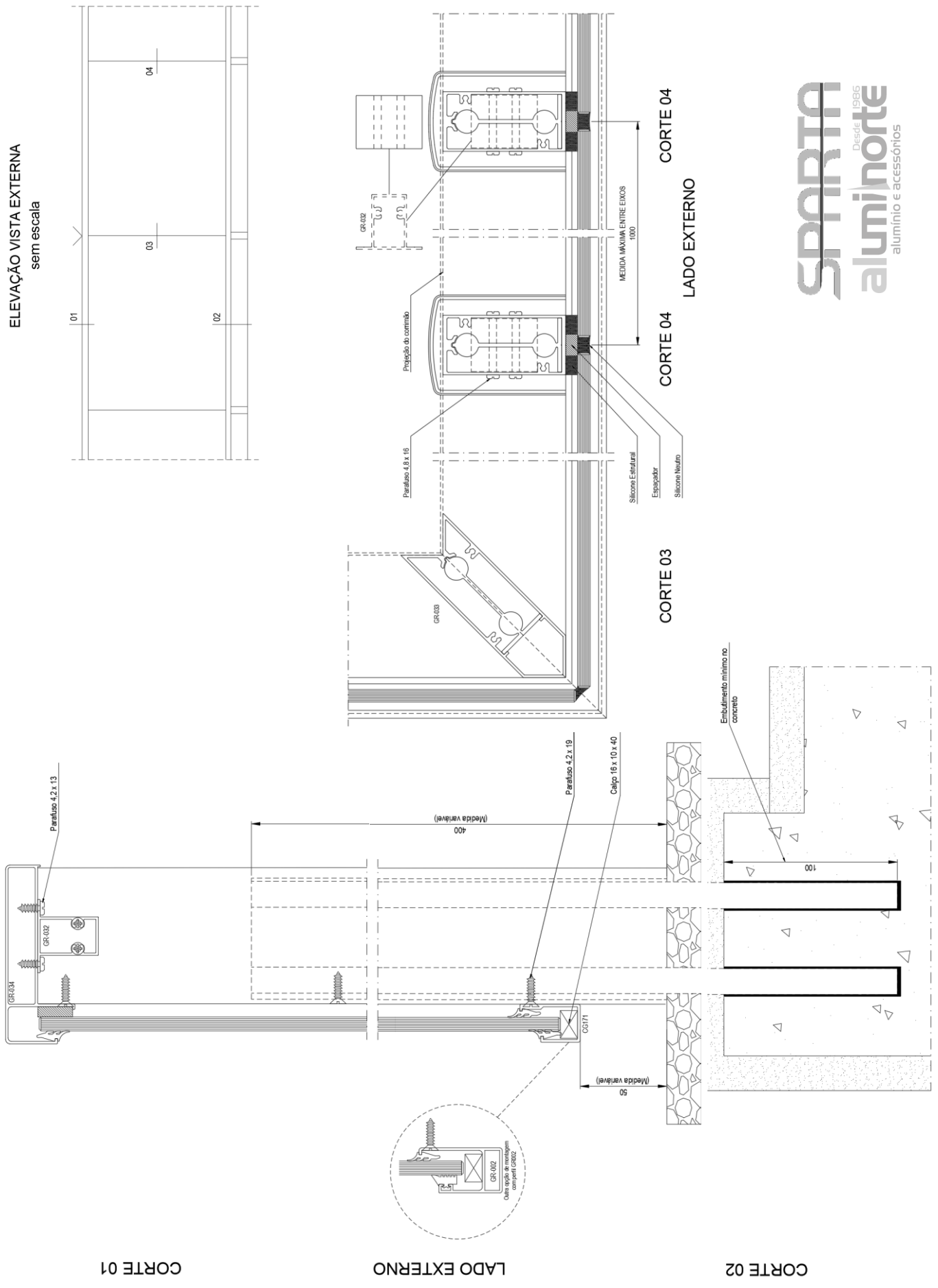

GUARDA CORPO COM CORRIMÃO RETO COM BARROTE VERTICAL E COLUNA DE CANTO COM FIXAÇÃO DIRETO AO CHÃO

ELEVAÇÃO VISTA EXTERNA
sem escala

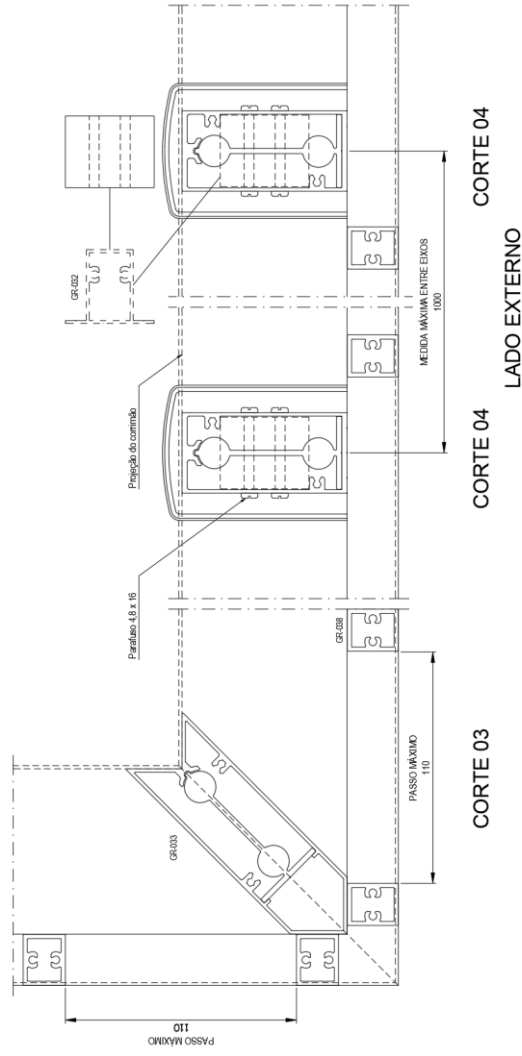
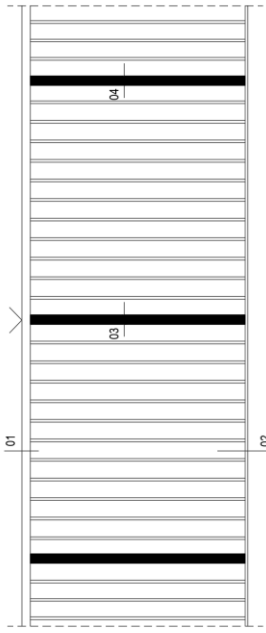

CORTE 04 LADO EXTERNO

CORTE 03

SPARTA
Desde 1986
aluminorte
alumínio e acessórios

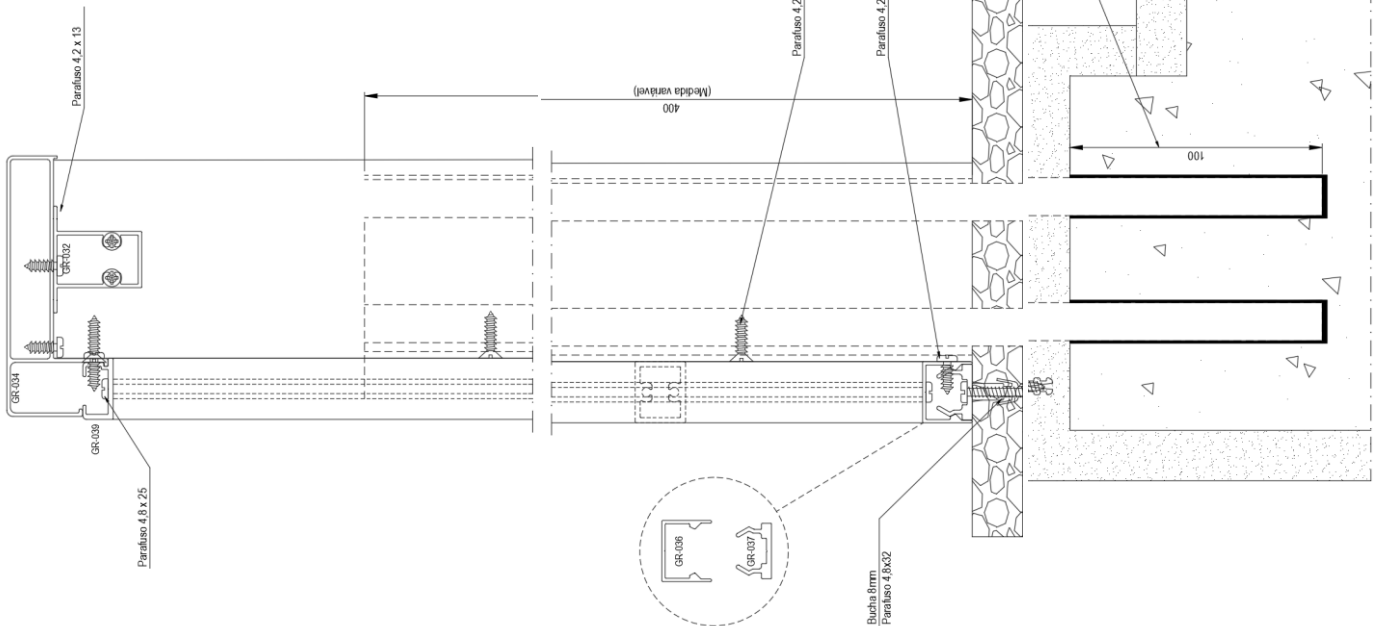

CORTE 01

LADO EXTERNO

CORTE 02

*dimensões em milímetros

PROJETOS ORIENTATIVOS

GUARDA CORPO COM CORRIMÃO RETO COM BARROTE VERTICAL E COLUNA DE CANTO COM FIXAÇÃO NO PERFIL JOTA



ELEVAÇÃO VISTA EXTERNA sem escala

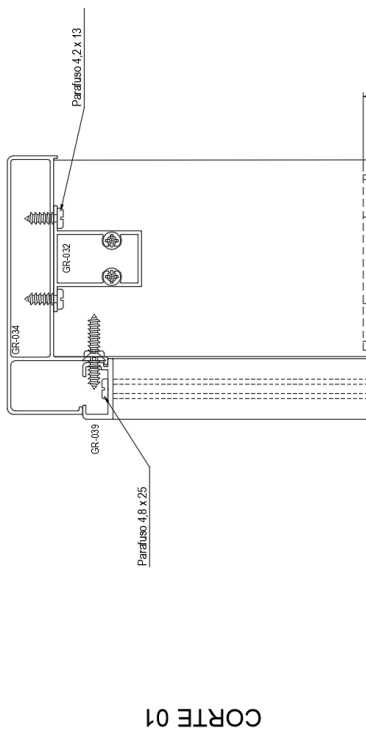
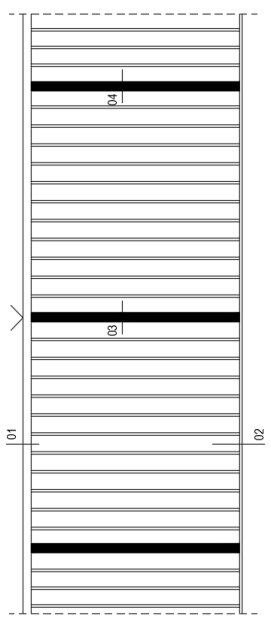

CORTE 01

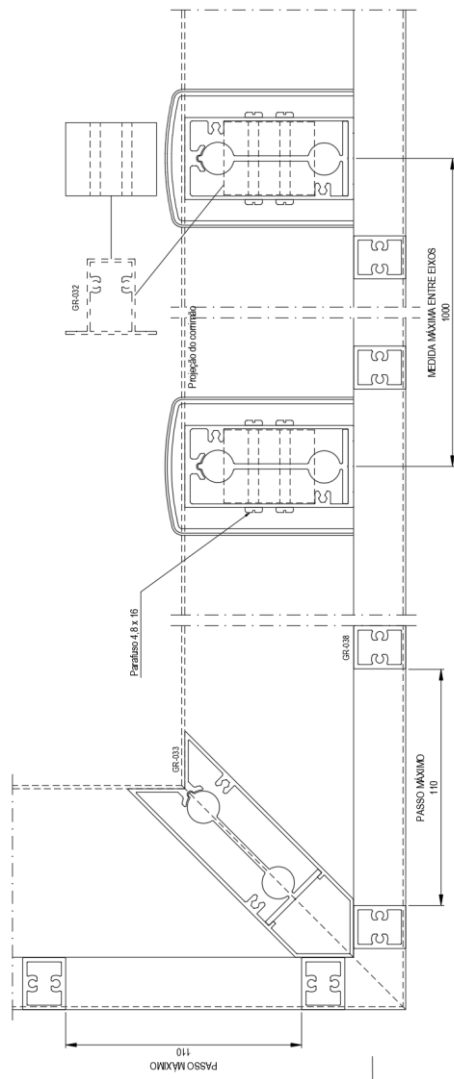

CORTE 04

CORTE 04 LADO EXTERNO

CORTE 03

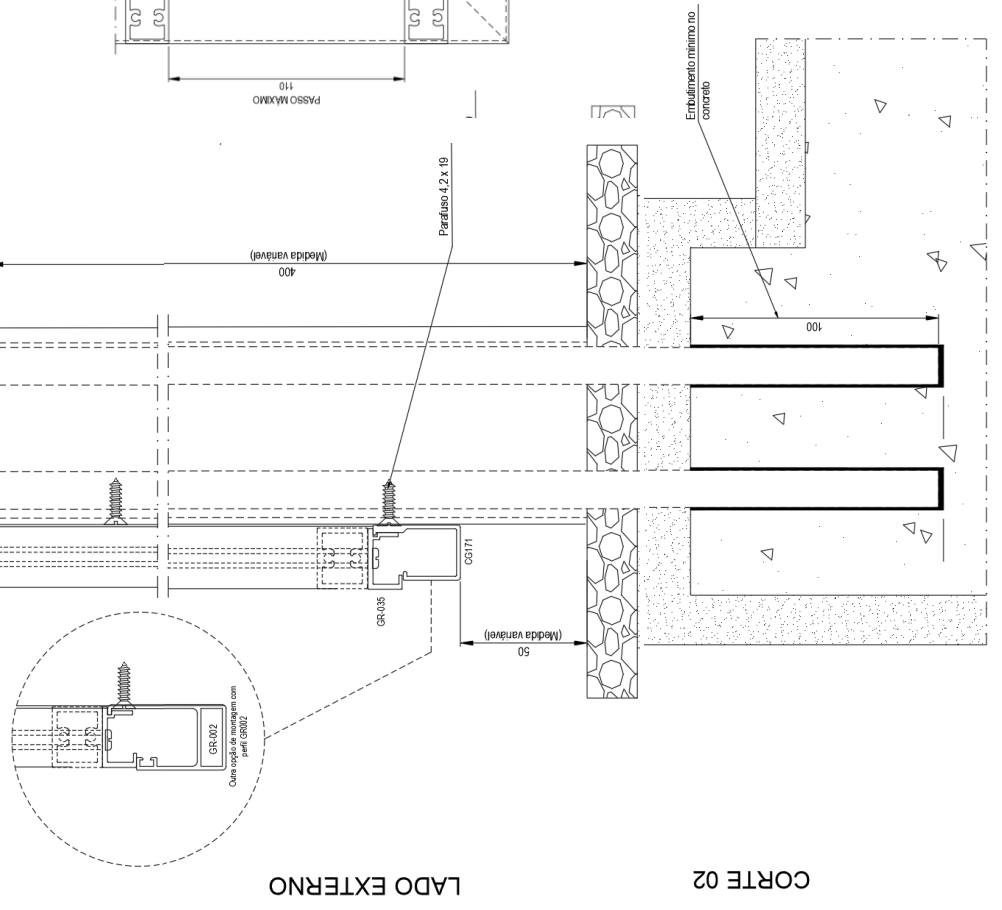

CORTE 02

LADO EXTERNO

*dimensões em milímetros

ELEVAÇÃO VISTA EXTERNA
sem escada

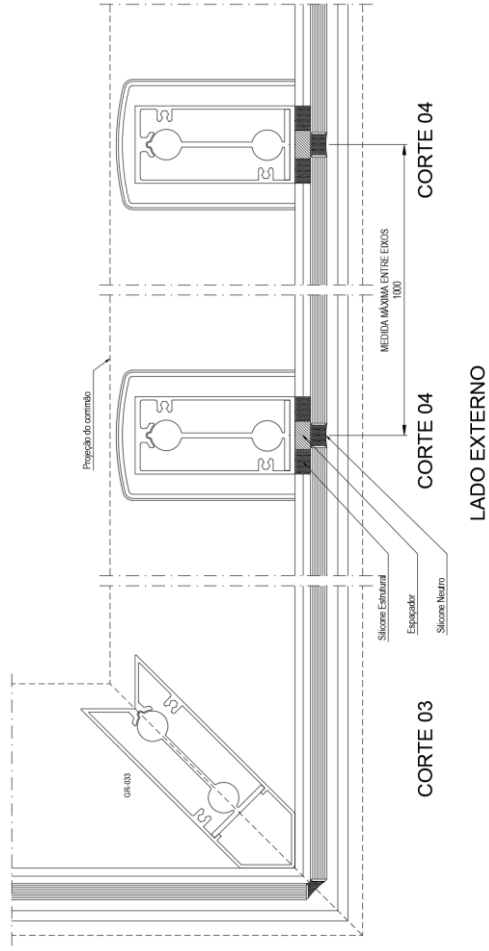
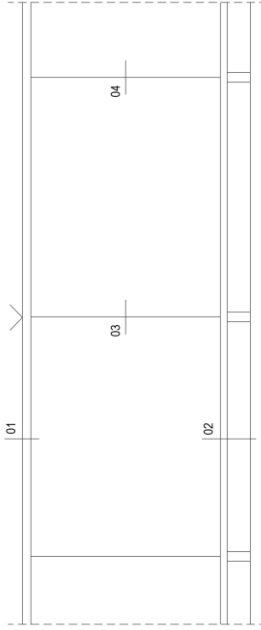

SPARTA
Desde 1986
aluminorte
alumínio e acessórios

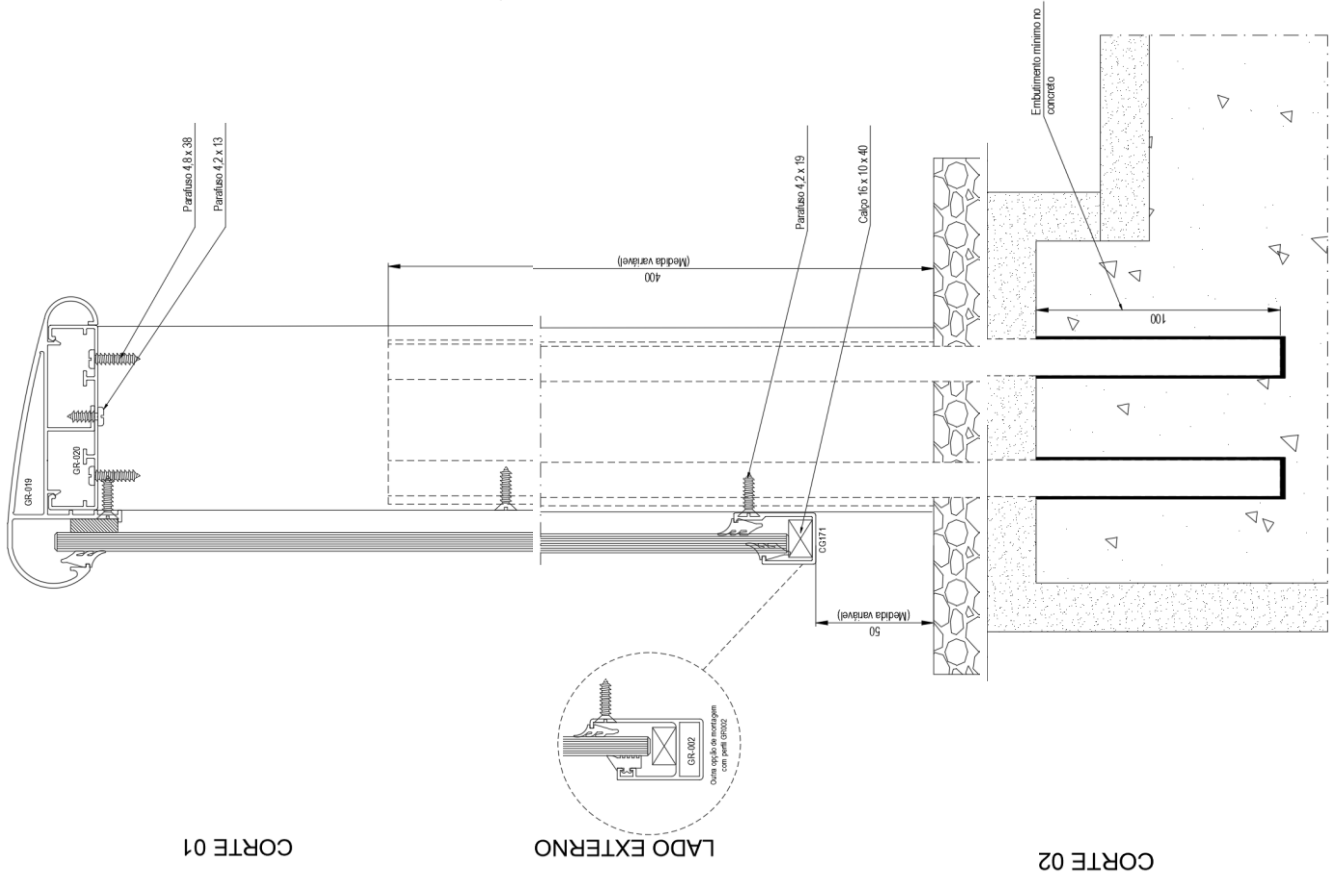

*dimensões em milímetros

PROJETOS ORIENTATIVOS

GUARDA CORPO COM CORRIMÃO CURVO, BARROTES HORIZONTAIS E COLUNA DE CANTO

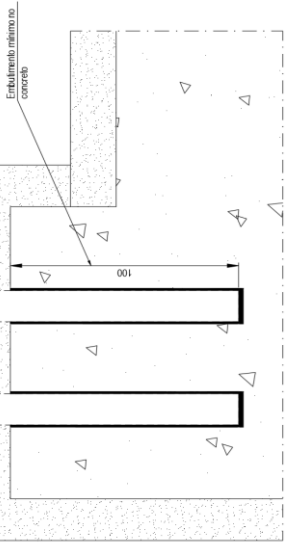
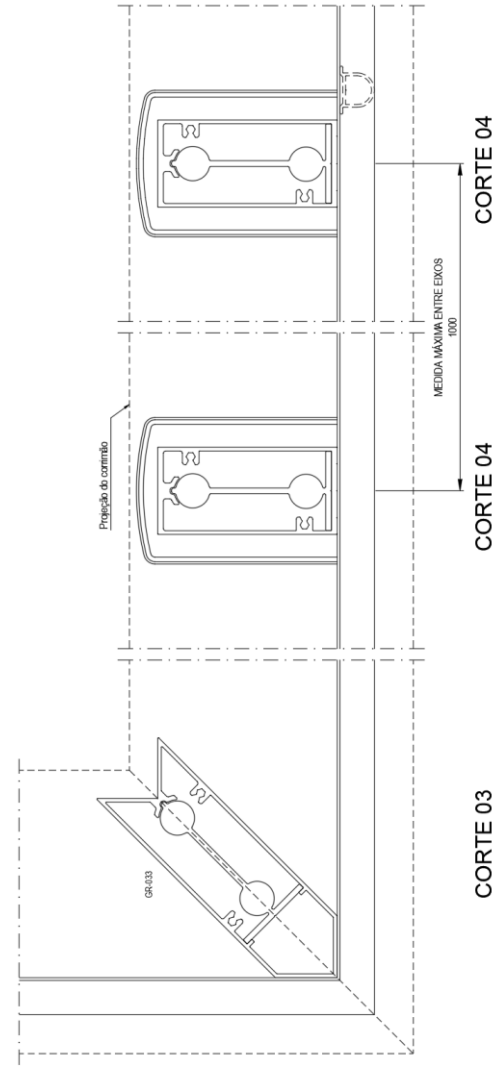
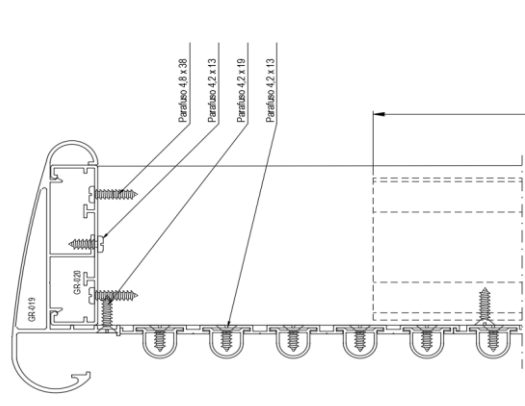
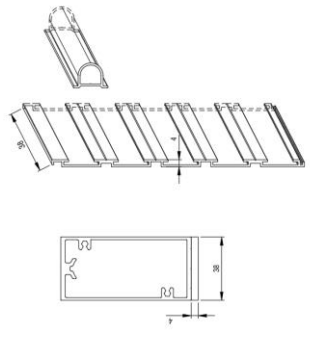
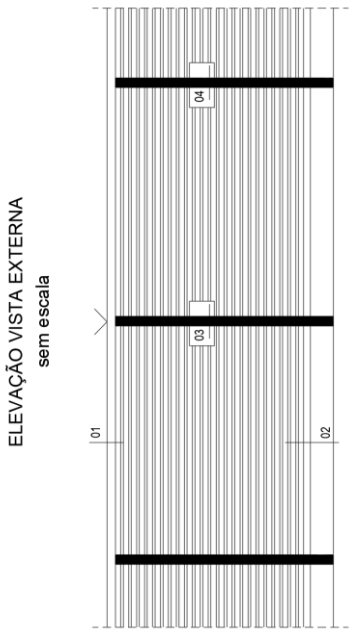

LADO EXTERNO



Obrigado,

Desde 1986
aluminorte
alumínio e acessórios

Conheça os nossos
sistemas no site:

Acesse o qr code e confira!



Nos acompanhe nas
redes sociais e fique
por dentro!
@aluminorte

Ou entre em contato pelo telefone:
22814822