

Desde 1986
aluminorte
alumínio e acessórios

Soluções para
alumínio desde
1986

SP-EURO45  [®]

Sistema
Aluminorte
Cátalogo completo

VERSÃO VI - Abril 2024

SP-EURO45



Rw= 36 dB

NA JANELA INTEGRADA COM VIDRO DE 10 MM



EXCELENTE PERFORMANCE EM TERMOACÚSTICA



SISTEMA DE ALTO PADRÃO IDEAL PARA GRANDES VÃOS



OPÇÃO **ELEVÁVEL**

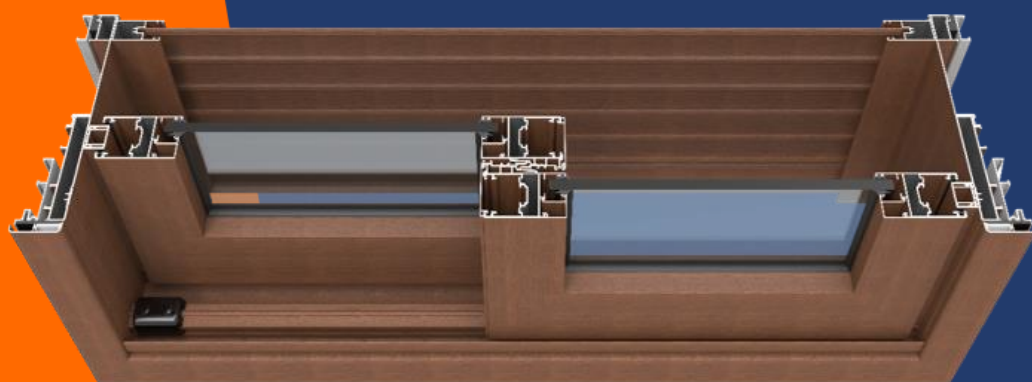

aluminorte Desde 1986
alumínio e acessórios

ÍNDICE DE PERFIS	01
PERFIS	02
COMPONENTES	27
TABELA DE VIDROS	32
TIPOLOGIAS	38
NORMAS	41
DIAGRAMA DE PRESSÃO	43
PROJETOS ORIENTATIVOS	56



ÍNDICE DE PERFIS

CÓDIGO	PESO	PÁG	CÓDIGO	PESO	PÁG
45EC - 091	2,169 Kg/m	14	45EC - 249	0,785 Kg/m	20
45EC - 095	0,488 Kg/m	5	45EC - 250	1,545 Kg/m	21
45EC - 096	0,478 Kg/m	5	45EC - 251	0,140 Kg/m	19
45EC - 100	0,693 Kg/m	8	45EC - 252	0,511 Kg/m	19
45EC - 133	0,648 Kg/m	13	45EC - 253	2,247 Kg/m	22
45EC - 200	0,532 Kg/m	2	45EC - 254	1,076 Kg/m	18
45EC - 201	0,511 Kg/m	2	45EC - 255	0,657 Kg/m	18
45EC - 203	0,162 Kg/m	22	45EC - 258	0,574 Kg/m	17
45EC - 204	0,225 Kg/m	2	45EC - 263	1,151 Kg/m	3
45EC - 205	0,151 Kg/m	2	45EC - 267	1,010 Kg/m	16
45EC - 208	0,207 Kg/m	7	45EC - 268	0,846 Kg/m	16
45EC - 209	0,345 Kg/m	7	45EC - 269	1,117 Kg/m	17
45EC - 210	0,288 Kg/m	18	45EC - 270	1,737 Kg/m	10
45EC - 212	0,274 Kg/m	7	45EC - 271	2,235 Kg/m	10
45EC - 219	2,306 Kg/m	3	45EC - 272	2,235 Kg/m	12
45EC - 221	1,429 Kg/m	3	CPU - 401	1,220 Kg/m	25
45EC - 222	3,579 Kg/m	4	CPU - 402	1,508 Kg/m	24
45EC - 223	0,953 Kg/m	14	CPU - 403	1,279 Kg/m	24
45EC - 225	0,215 Kg/m	7	CPU - 404	1,242 Kg/m	25
45EC - 226	0,281 Kg/m	5	CPU - 405	0,963 Kg/m	25
45EC - 228	0,404 Kg/m	7	DS - 238	0,521 Kg/m	26
45EC - 229	0,513 Kg/m	15	ECBG - 213	0,278 Kg/m	23
45EC - 231	1,386 Kg/m	8	ECBG - 214	0,274 Kg/m	23
45EC - 232	0,331 Kg/m	9	ECBG - 215	0,261 Kg/m	23
45EC - 233	0,833 Kg/m	12	ECBG - 216	0,234 Kg/m	23
45EC - 234	1,439 Kg/m	9	ECBG - 217	0,227 Kg/m	23
45EC - 235	1,942 Kg/m	11	ECBG - 218	0,185 Kg/m	23
45EC - 236	1,942 Kg/m	11	IS - M30	0,115 Kg/m	6
45EC - 237	0,524 Kg/m	13	IS - M31	0,108 Kg/m	6
45EC - 238	0,211 Kg/m	13	MN - 015	0,881 Kg/m	26
45EC - 239	1,000 Kg/m	15	MN - 055	0,371 Kg/m	26
45EC - 240	2,466 Kg/m	4	PR - 003	0,171 Kg/m	6
45EC - 247	1,011 Kg/m	16	SPI - I04	0,687 Kg/m	26
45EC - 248	1,099 Kg/m	20	U - 491	0,093 Kg/m	18

45EC - 201

Contramarco
0,511 Kg/m

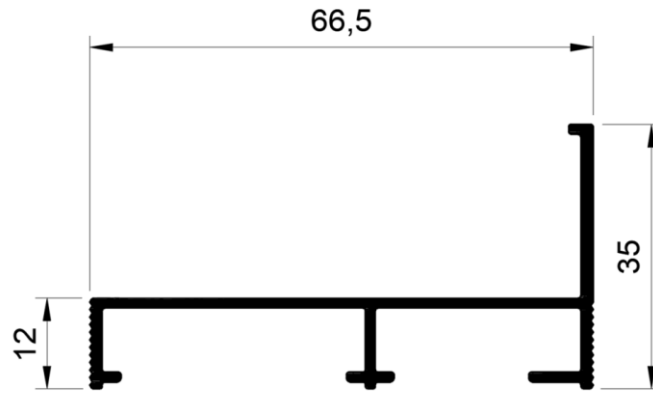

45EC - 205

Presilha do Arremate
0,151 Kg/m

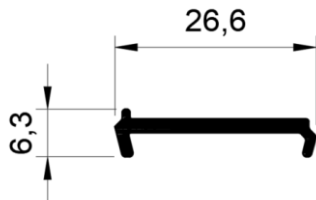

45EC - 204

Arremate
0,225 Kg/m

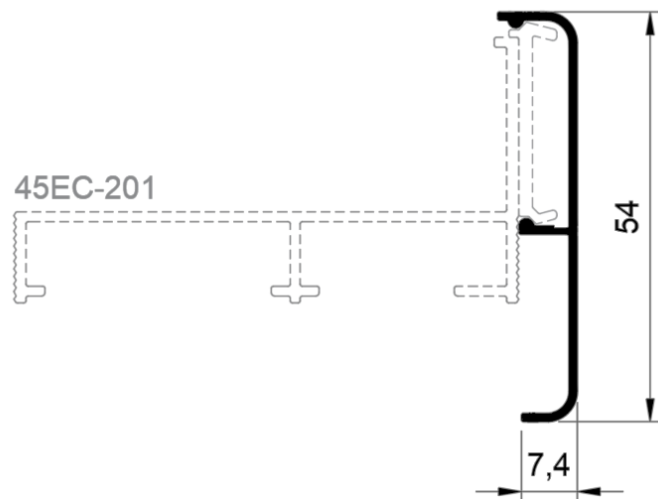

45EC - 200

Contramarco Bi-partido
0,532 Kg/m

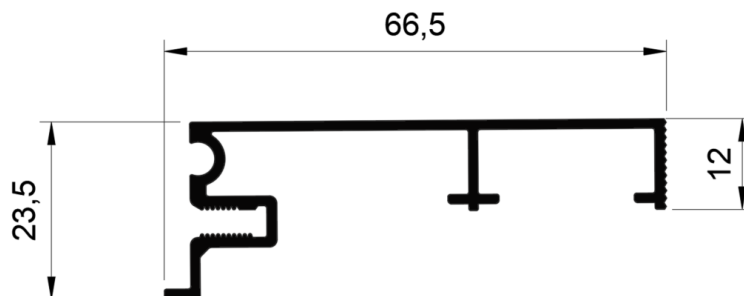

45EC - 219

Marco Horizontal Inferior
02 planos
2,306 Kg/m

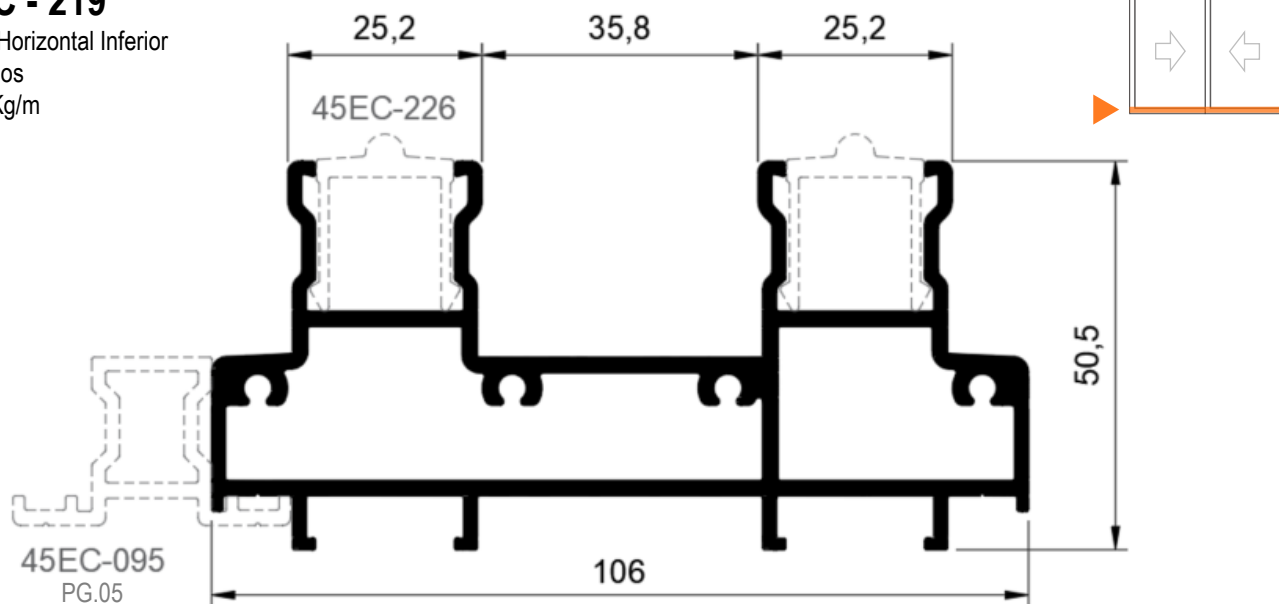

45EC - 221

Marco Vertical 02 planos
1,429 Kg/m

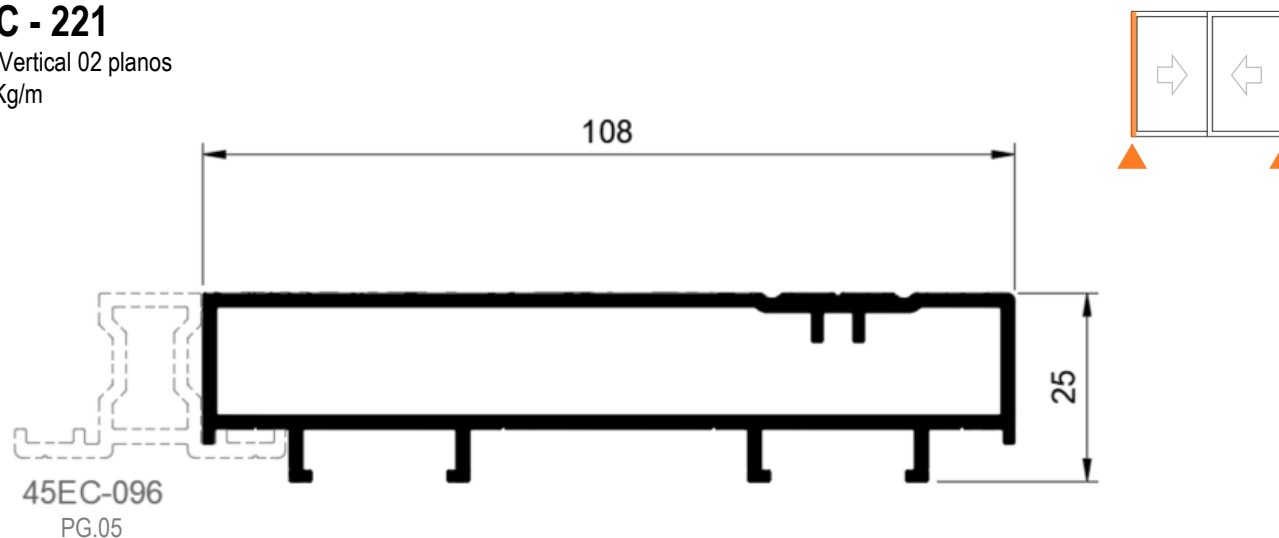

Jx= 3,665 cm ⁴	Wx= 2,486 cm ³
Jy= 62,206 cm ⁴	Wy= 11,238 cm ³

45EC - 263

Marco Intermediário
para peitoril e bandeira
1,151 Kg/m

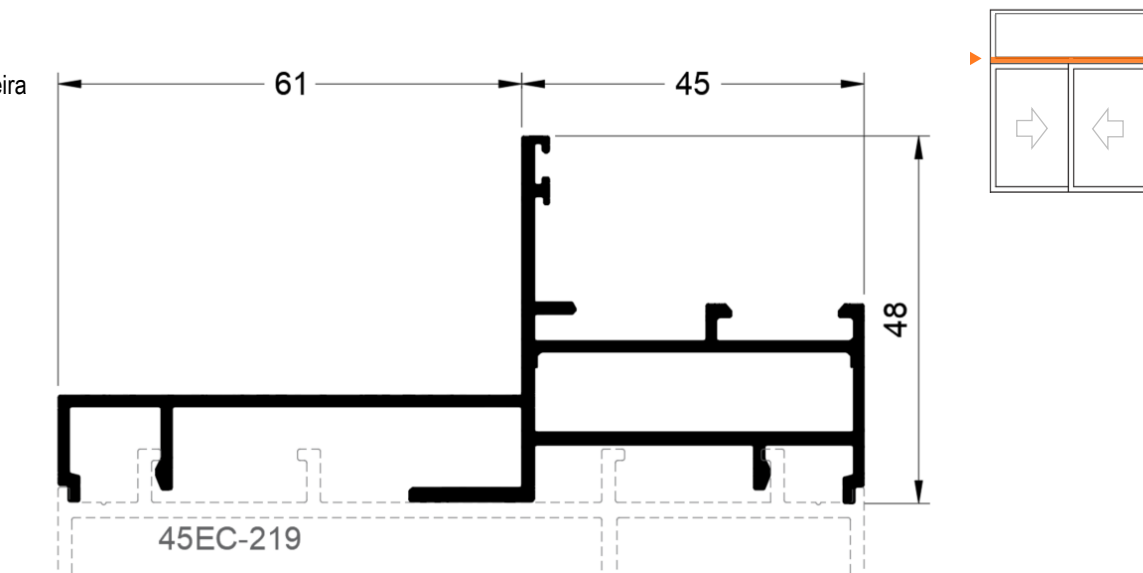

45EC - 222

Marco Horizontal Inferior 03 planos
3,579 Kg/m

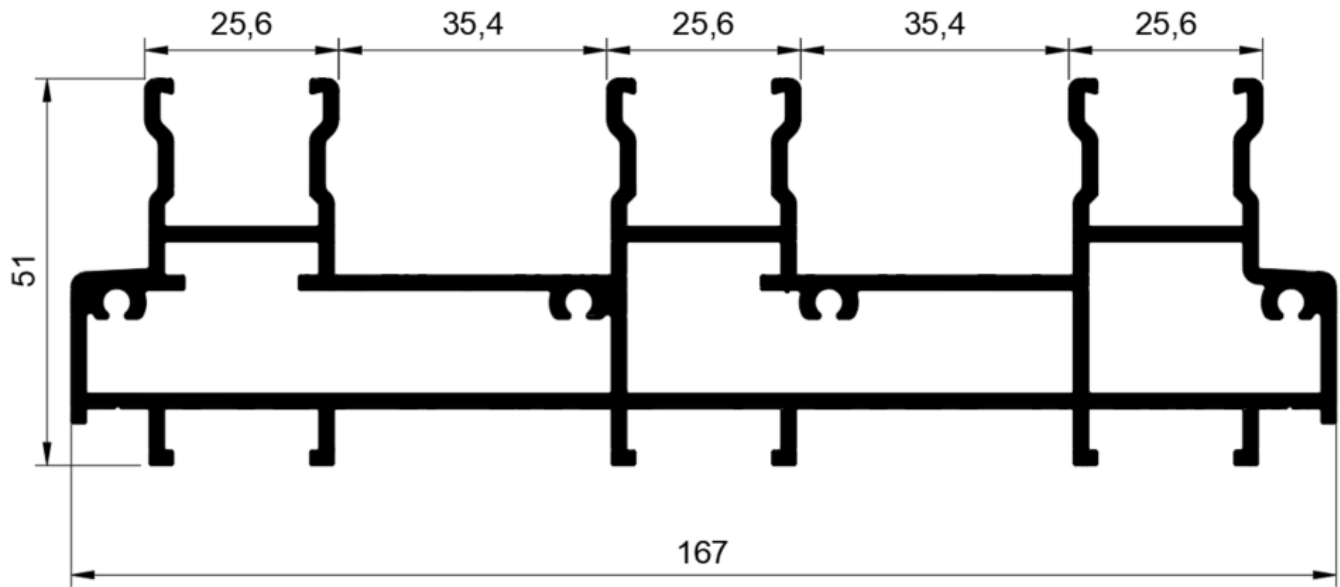
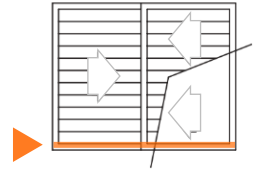

45EC - 240

Marco Vertical Lateral 03 planos
2,466 Kg/m

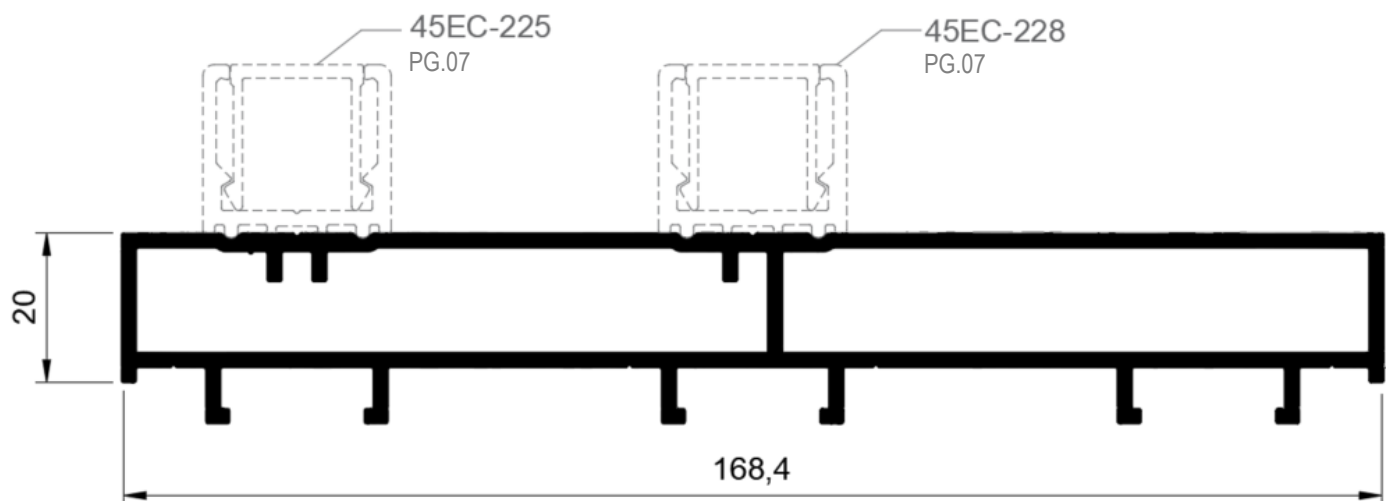

$J_x = 6,330 \text{ cm}^4$	$W_x = 4,183 \text{ cm}^3$
$J_y = 241,096 \text{ cm}^4$	$W_y = 28,031 \text{ cm}^3$

*dimensões em milímetros

45EC - 095

Complemento dos Marcos Horizontais
(Trilhos)
0,488 Kg/m

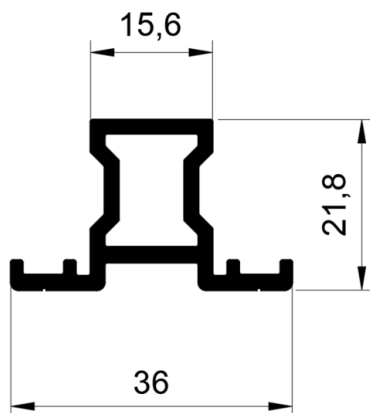
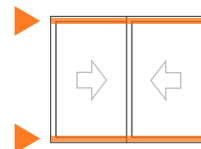

Configuração de planos "infinitos"
a partir de 02 planos, exemplos:

- 45EC-219 x 45EC-222
- 45EC-240 x 45EC-240
- 45EC-221 x 45EC-240

45EC - 096

Complemento dos Marcos Verticais
(Laterais)
0,478 Kg/m

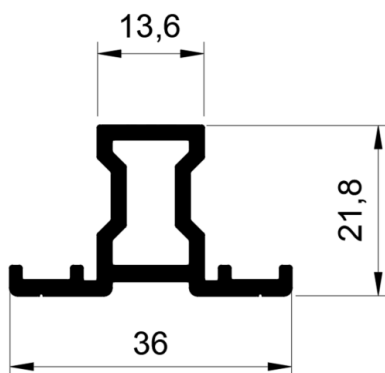
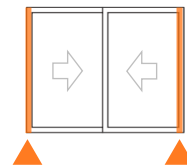

Configuração de planos "infinitos"
a partir de 02 planos, exemplos:

- 45EC-221 x 45EC-221
- 45EC-240 x 45EC-240
- 45EC-221 x 45EC-240

45EC - 226

Capa do Trilho
0,281 Kg/m

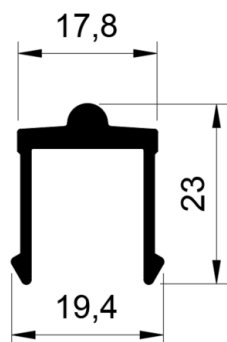
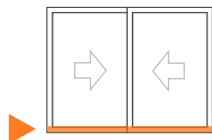

PR-003

Trilho "Macarrão"
0,171 Kg/m

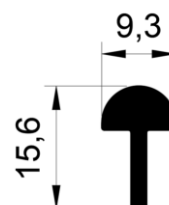
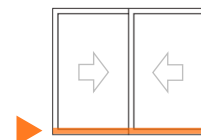

45EC - 225

Tampa do Mata Junta
0,215 Kg/m

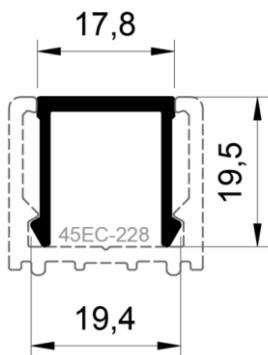
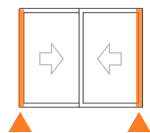

45EC - 208

Arremate do Marco
0,206 Kg/m

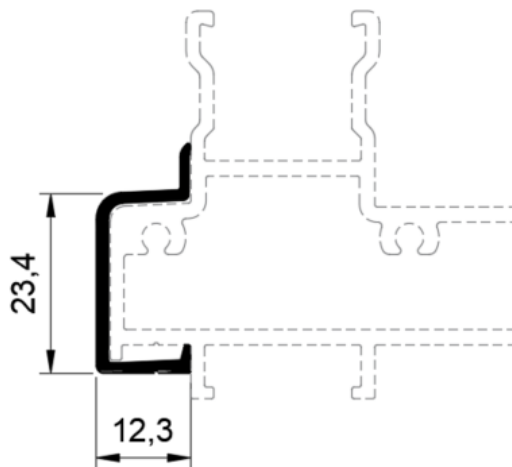
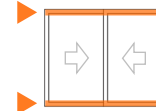

OBS: Usar perfil quando o trilho for partido ao meio

45EC - 228

Mata Junta Lateral
0,404 Kg/m

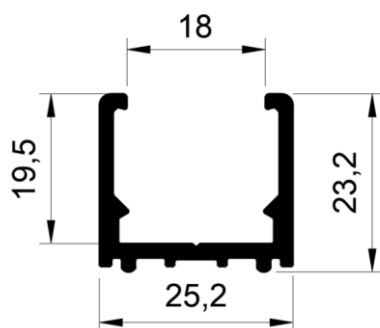
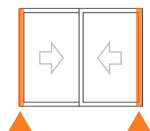

45EC - 212

Arremate do Marco
0,274 Kg/m

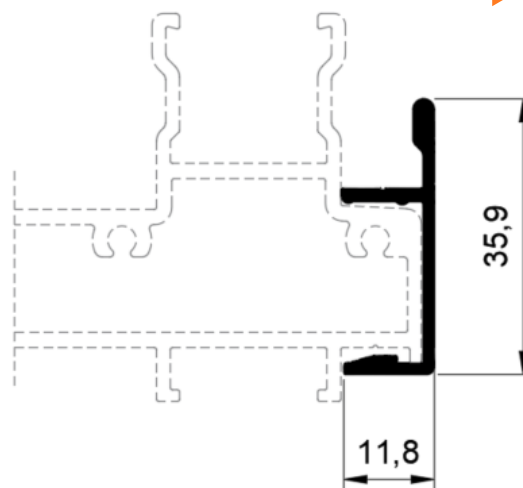
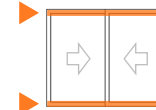

OBS: Usar perfil quando o trilho for partido ao meio

45EC - 209

Pingadeira
0,345 Kg/m

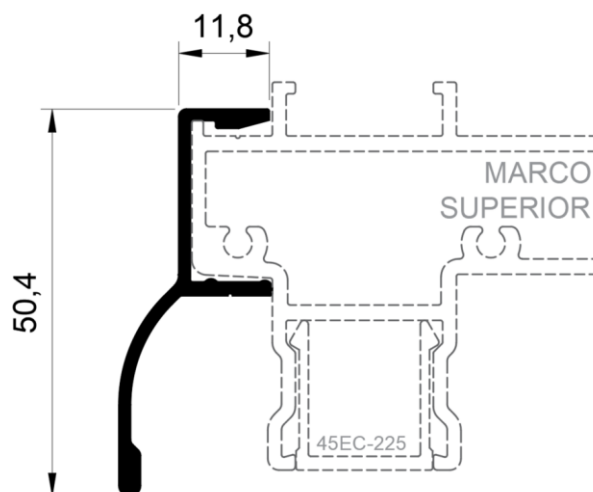
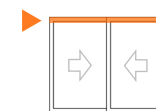

45EC - 100

Adaptador de Trilhos
0,693 Kg/m

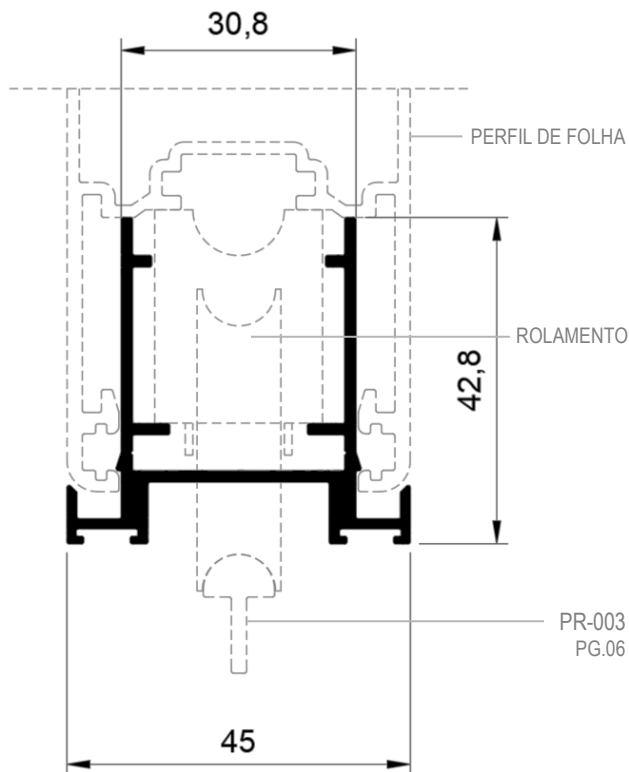
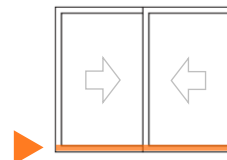

45EC - 231

Folha Perimetral
1,383 Kg/m

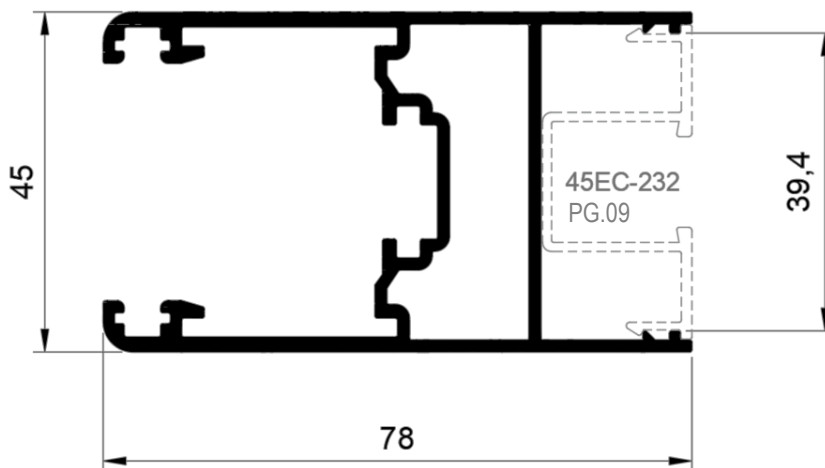
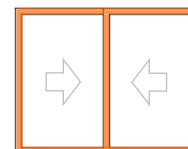

Jx= 17,380 cm ⁴	Wx= 7,724 cm ³
Jy= 22,351 cm ⁴	Wy= 5,569 cm ³

*dimensões em milímetros

45EC - 232

Porta Vidro
0,331 Kg/m

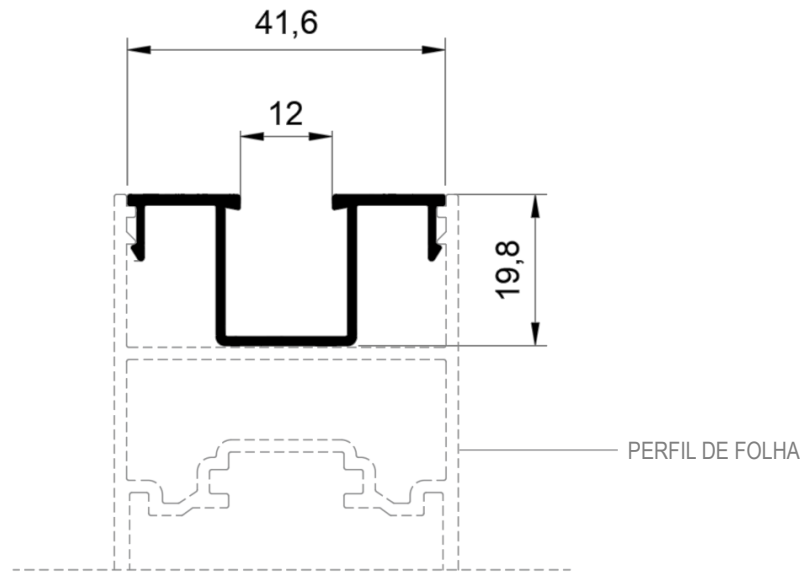
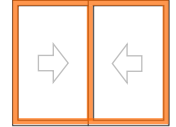

OBS: Usar com vidros de 4 a 8 milímetros

45EC - 234

Folha Perimetral
1,439 Kg/m

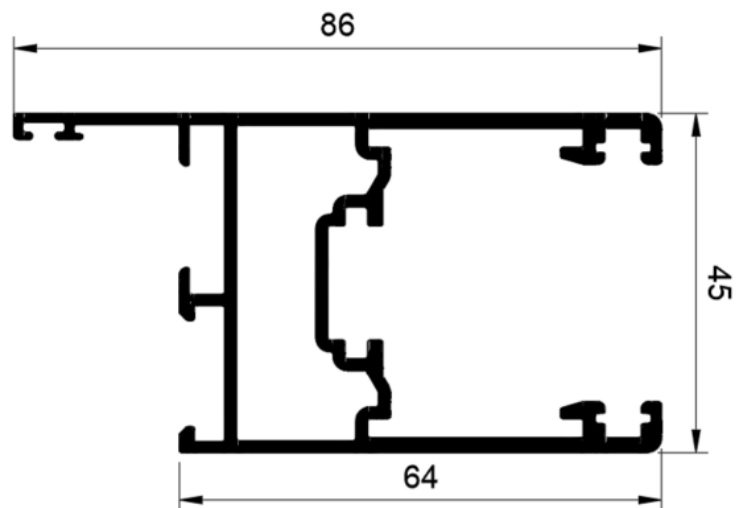
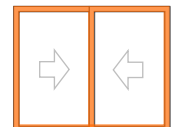

Jx= 17,262 cm ⁴	Wx= 7,162 cm ³
Jy= 24,806 cm ⁴	Wy= 5,200 cm ³

*dimensões em milímetros

45EC - 270

Folha Perimetral
1,737 Kg/m

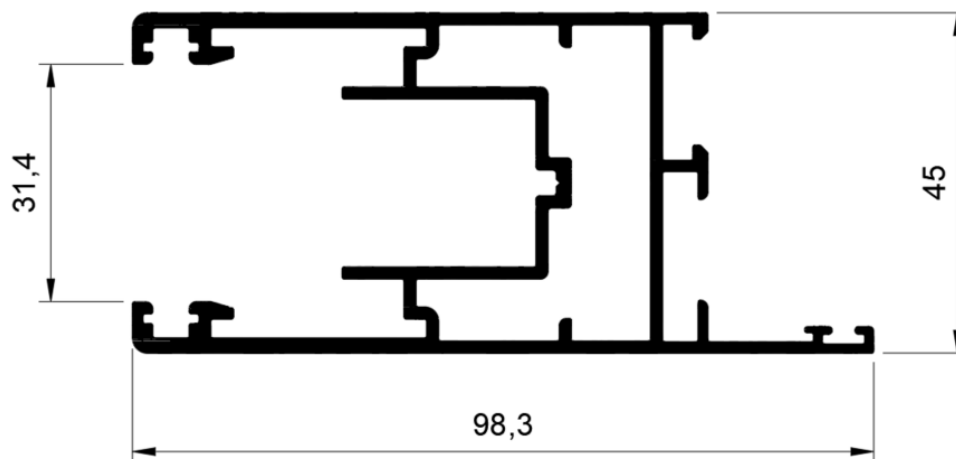
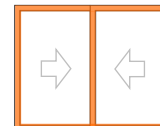

Jx= 20,347 cm ⁴	Wx= 8,513 cm ³
Jy= 38,998 cm ⁴	Wy= 7,221 cm ³

45EC - 271

Folha com Câmara Europeia com Reforço
2,235 Kg/m

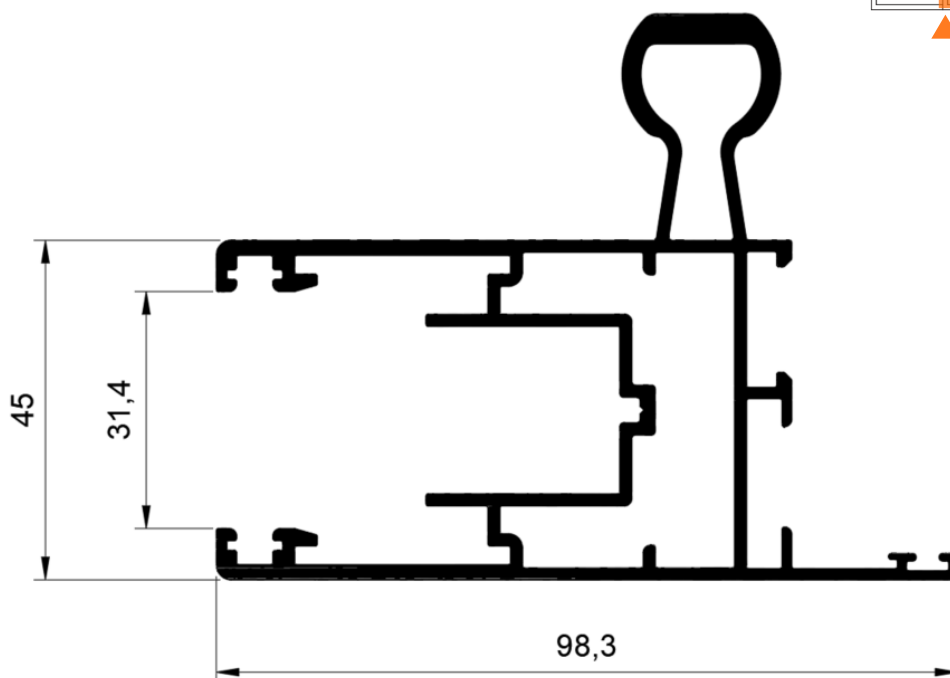
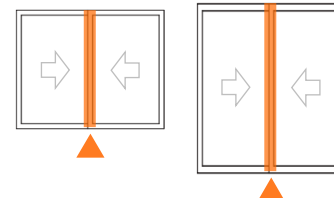

Jx= 48,542 cm ⁴	Wx= 10,984 cm ³
Jy= 45,406 cm ⁴	Wy= 9,173 cm ³

*dimensões em milímetros

45EC - 235

Folha com reforço
1,942 Kg/m

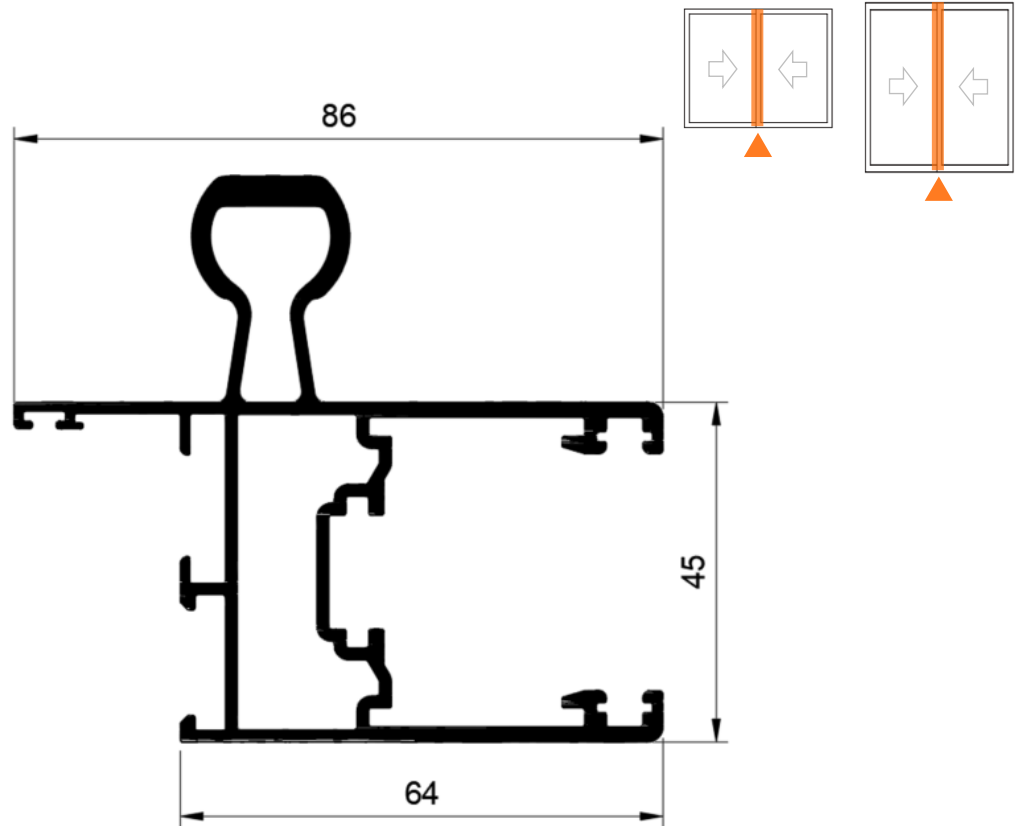

$J_x = 40,871 \text{ cm}^4$	$W_x = 10,091 \text{ cm}^3$
$J_y = 28,090 \text{ cm}^4$	$W_y = 6,369 \text{ cm}^3$

45EC - 236

Folha com reforço
1,942 Kg/m

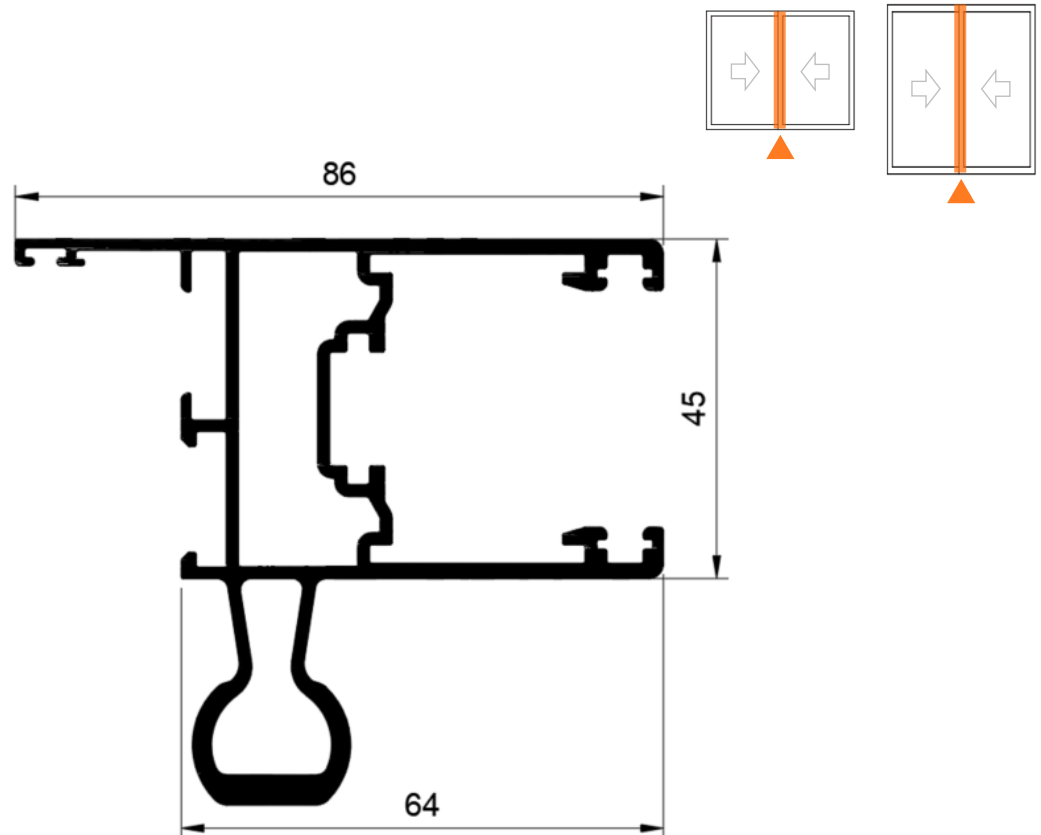

$J_x = 44,580 \text{ cm}^4$	$W_x = 13,602 \text{ cm}^3$
$J_y = 28,090 \text{ cm}^4$	$W_y = 6,396 \text{ cm}^3$

*dimensões em milímetros

45EC - 272

Folha com Câmara Europeia com Reforço
2,235 Kg/m

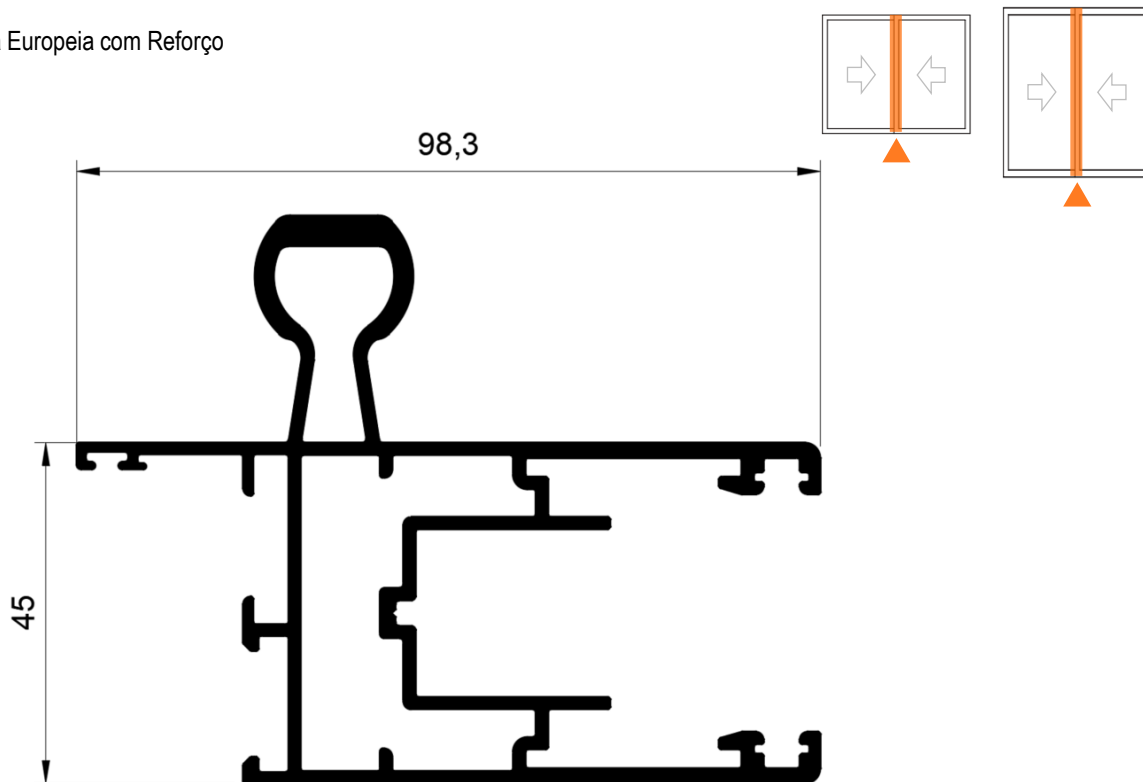

Jx= 45,287 cm ⁴	Wx= 10,759 cm ³
Jy= 45,406 cm ⁴	Wy= 9,173 cm ³

45EC - 233

Mão de Amigo
0,833 Kg/m

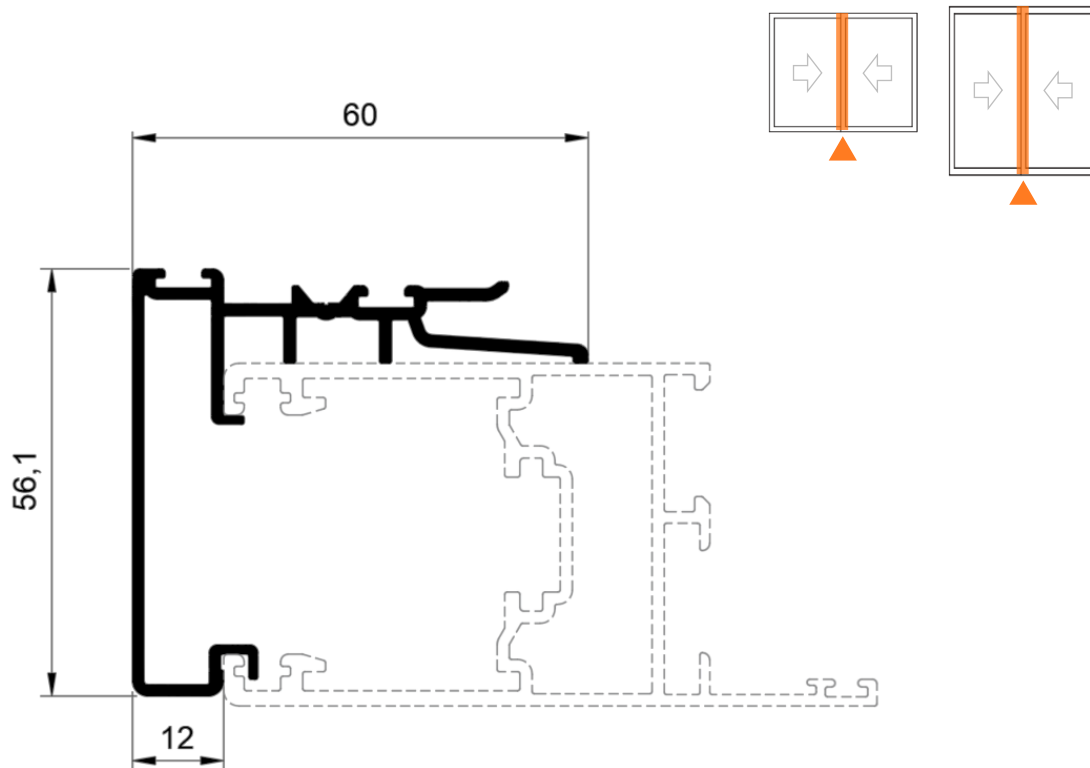

Jx= 9,613 cm ⁴	Wx= 2,503 cm ³
Jy= 9,308 cm ⁴	Wy= 2,248 cm ³

*dimensões em milímetros

45EC - 237

Mão de Amigo
0,524 Kg/m

OBS: Usar somente nos perfis
45EC-231, 45EC-234, 45EC-235 e 45EC-236

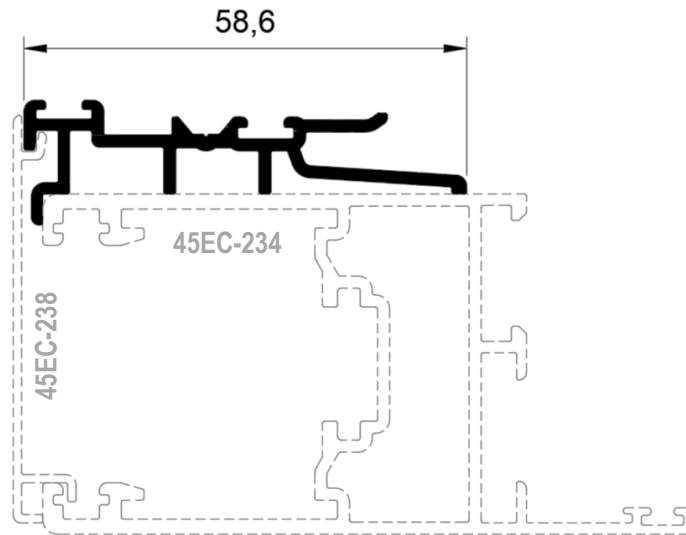
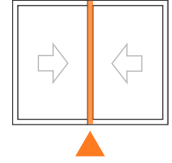

$J_x = 0,221 \text{ cm}^4$	$W_x = 0,233 \text{ cm}^3$
$J_y = 5,494 \text{ cm}^4$	$W_y = 1,650 \text{ cm}^3$

45EC - 133

Mão de Amigo
0,648 Kg/m

OBS: Usar somente nos perfis
45EC-270, 45EC-271 e 45EC-272

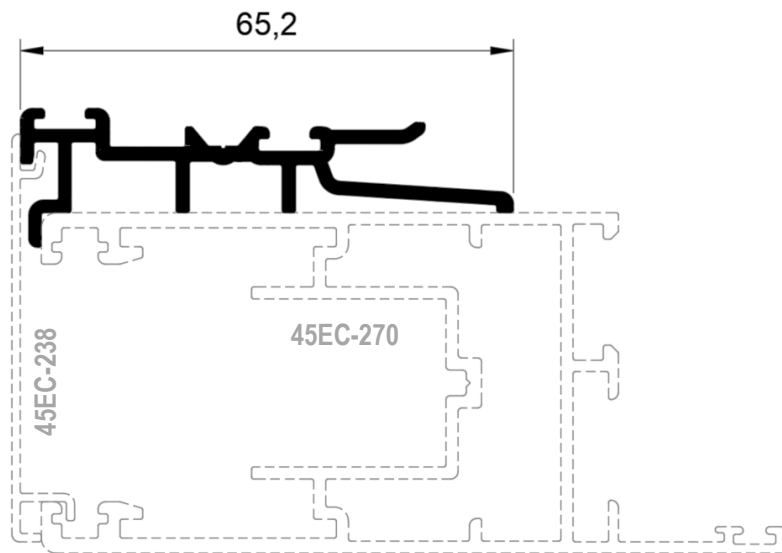
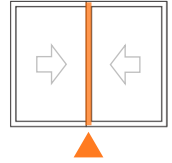

$J_x = 0,339 \text{ cm}^4$	$W_x = 0,308 \text{ cm}^3$
$J_y = 8,420 \text{ cm}^4$	$W_y = 2,275 \text{ cm}^3$

45EC - 238

Complemento da Mão de Amigo
0,211 Kg/m

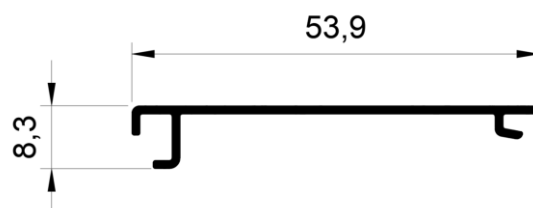
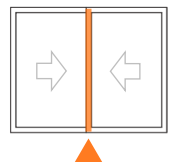

*dimensões em milímetros

45EC - 091

Montante Central com Reforço SLIM
2,169 Kg/m

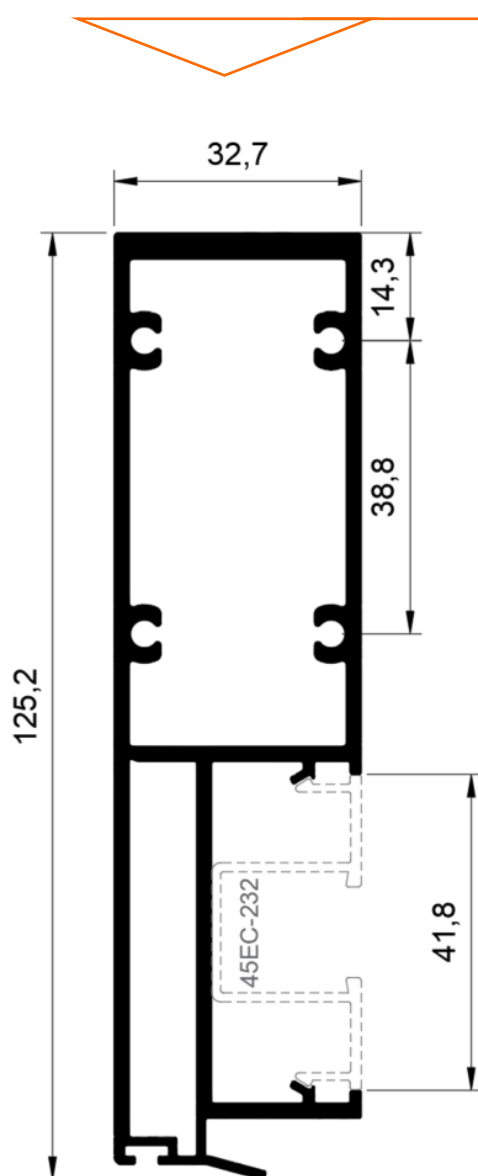

Perfis com vista frontal de **32 mm**

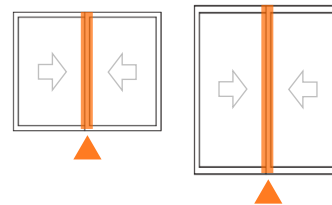

$Jx= 126,557 \text{ cm}^4$	$Wx= 18,456 \text{ cm}^3$
$Jy= 11,801 \text{ cm}^4$	$Wy= 6,341 \text{ cm}^3$

45EC - 223

Montante Central SLIM
0,953 Kg/m

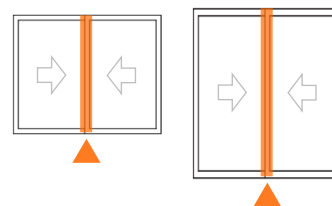
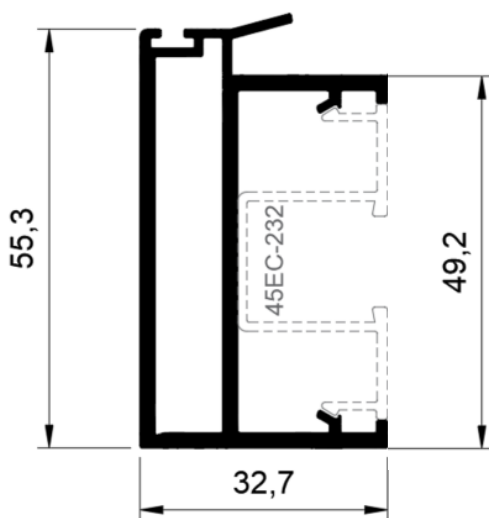

$Jx= 13,459 \text{ cm}^4$	$Wx= 4,427 \text{ cm}^3$
$Jy= 3,006 \text{ cm}^4$	$Wy= 1,398 \text{ cm}^3$

45EC - 229

Mata Junta Central
0,513 Kg/m

OBS: Aplicável aos perfis
45EC-231, 45EC-234, 45EC-235, 45EC-236, 45EC-270, 45EC-271 e 45EC-272

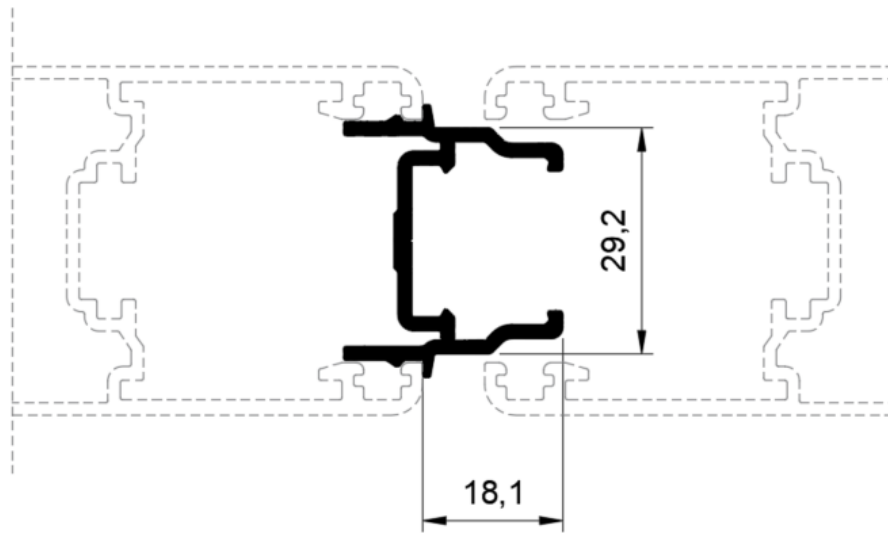
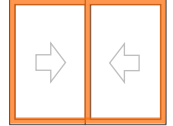

$J_x = 2,647 \text{ cm}^4$	$W_x = 1,504 \text{ cm}^3$
$J_y = 0,961 \text{ cm}^4$	$W_y = 0,616 \text{ cm}^3$

45EC - 239

Reforço da Folha
1,000 Kg/m

OBS: Aplicável aos perfis
45EC-231, 45EC-234, 45EC-235 e 45EC-236

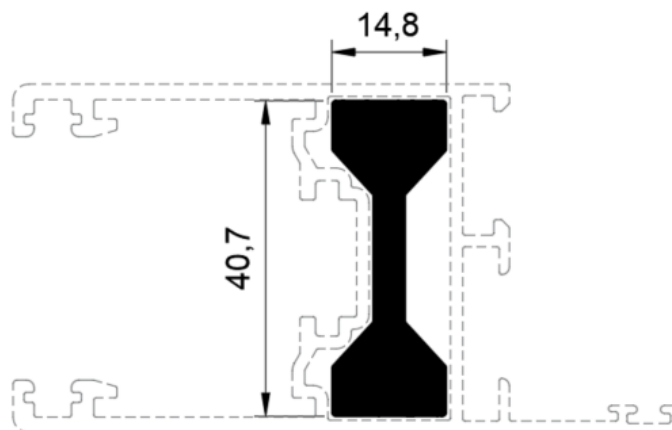
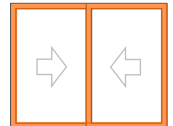

$J_x = 7,345 \text{ cm}^4$	$W_x = 3,600 \text{ cm}^3$
$J_y = 0,465 \text{ cm}^4$	$W_y = 0,629 \text{ cm}^3$

*dimensões em milímetros

45EC - 268

Marco
0,846 Kg/m

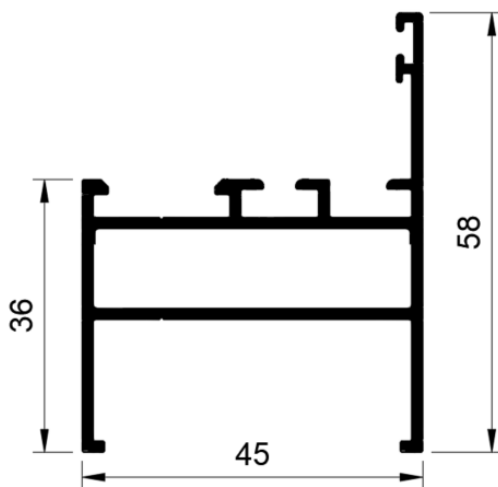
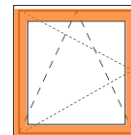

45EC - 247

Folha Maxim-ar
1,011 Kg/m

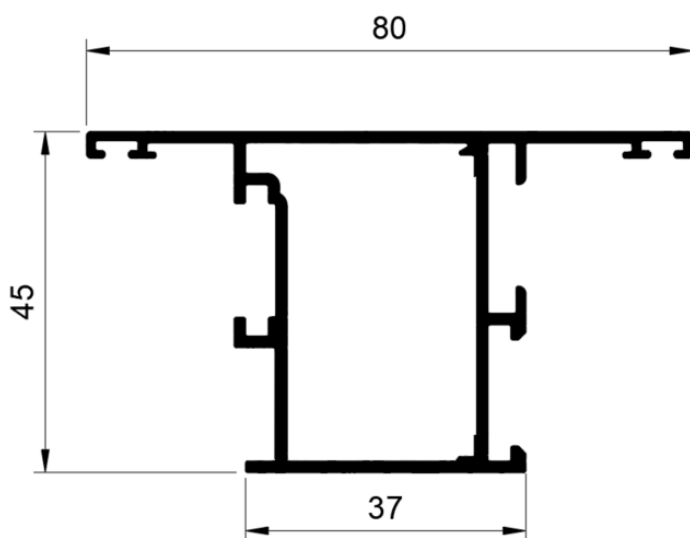
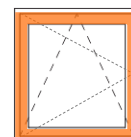

45EC - 267

Folha Oscilobatente
1,010 Kg/m

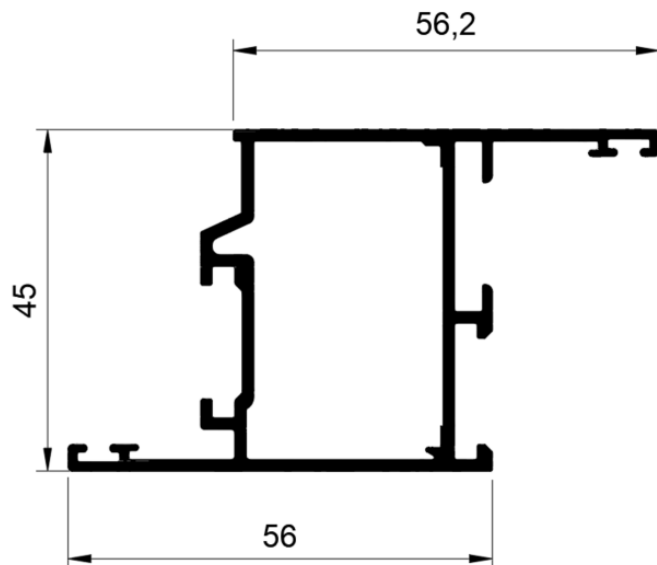
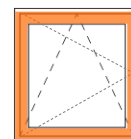

*dimensões em milímetros

45EC - 269

Coluna / Travessa Maxim-ar e Oscilobatente
1,117 Kg/m

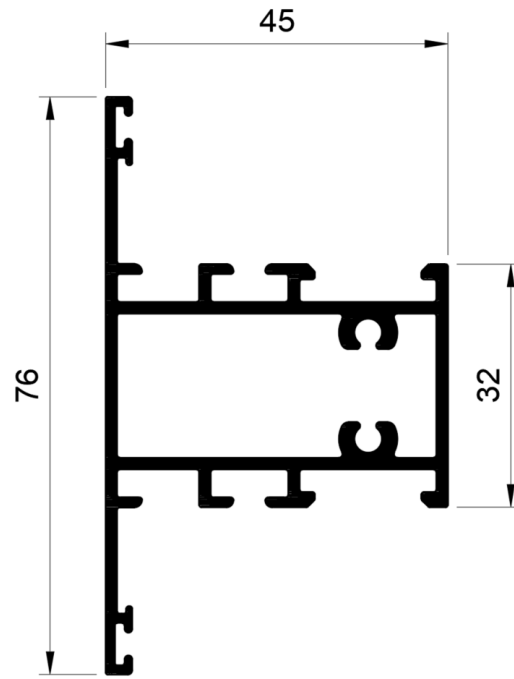
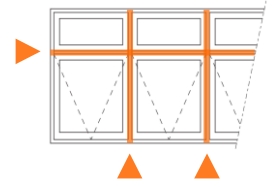

45EC - 258

Inversor de Baguete
0,574 Kg/m

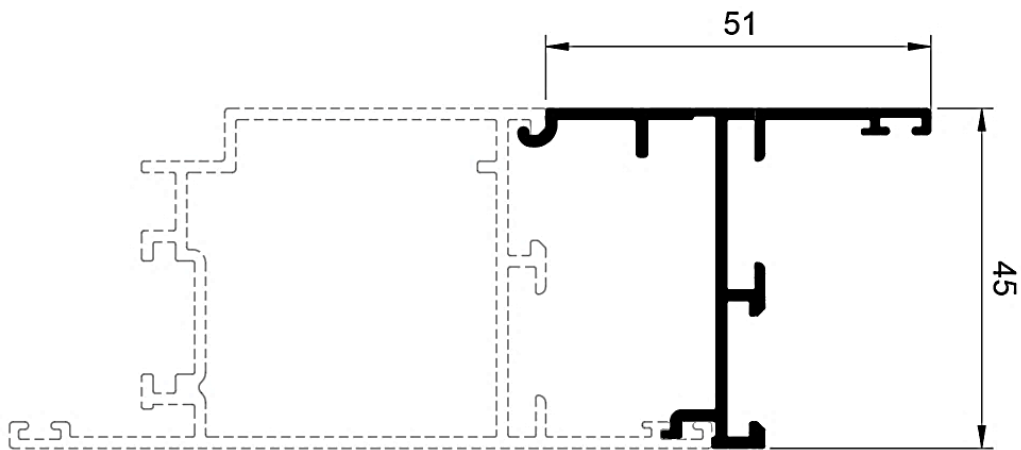
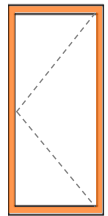

MAXIM-AR

45EC - 254

Travessa e Folhas Maxim-ar
1,076 Kg/m

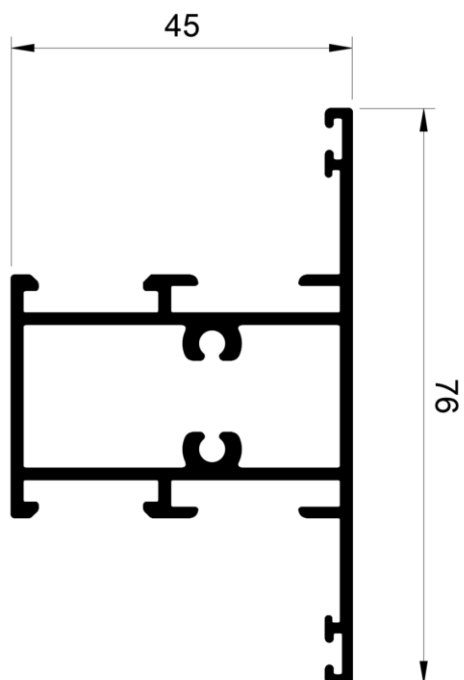
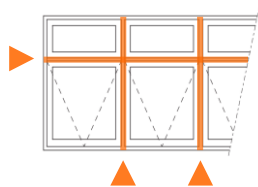

45EC - 255

Inversor Maxim-ar
0,657 Kg/m

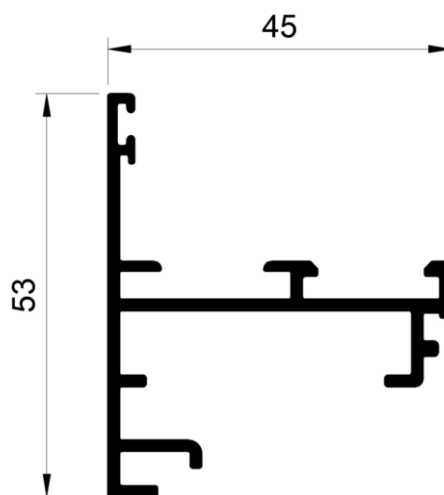
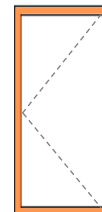

45EC - 210

Pingadeira Maxim-ar
0,288 Kg/m

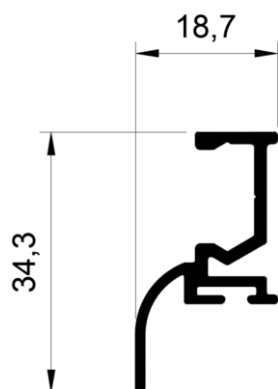
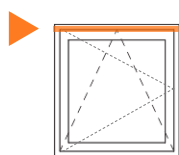

U - 491

Tampa da Pingadeira Maxim-ar
0,093 Kg/m

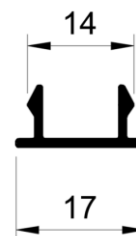
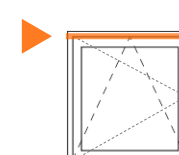

*dimensões em milímetros

45EC - 251

Folha da Porta de giro
1,140 Kg/m

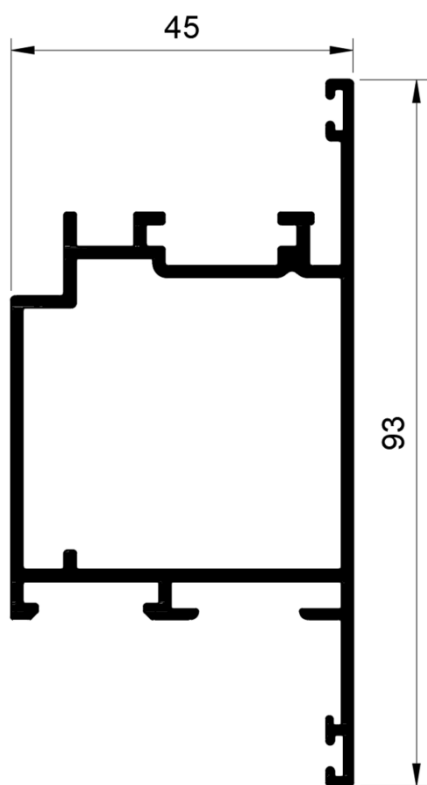
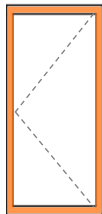

$J_x = 12,424 \text{ cm}^4$	$W_x = 4,620 \text{ cm}^3$
$J_y = 22,902 \text{ cm}^4$	$W_y = 4,802 \text{ cm}^3$

45EC - 252

Folha da Porta de giro
0,511 Kg/m

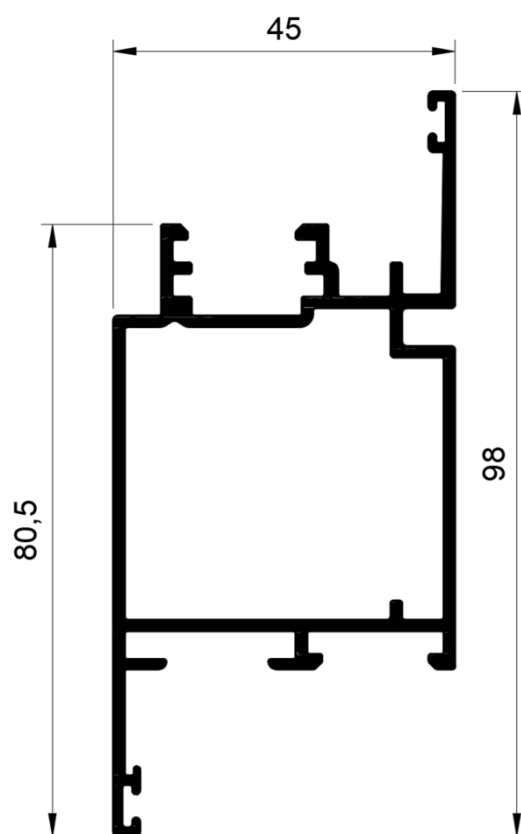
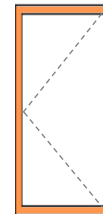

$J_x = 14,181 \text{ cm}^4$	$W_x = 6,149 \text{ cm}^3$
$J_y = 27,386 \text{ cm}^4$	$W_y = 5,402 \text{ cm}^3$

45EC - 249

Marco Perimetral Porta de Giro
0,785 Kg/m

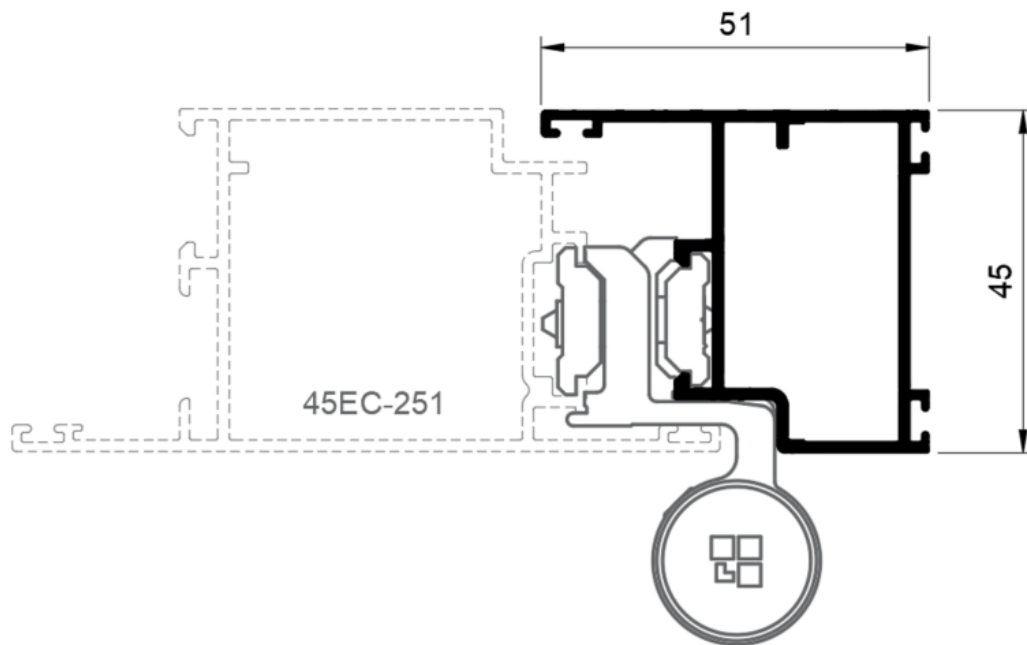
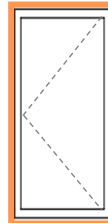

45EC - 248

Marco Perimetral Porta de Giro
1,099 Kg/m

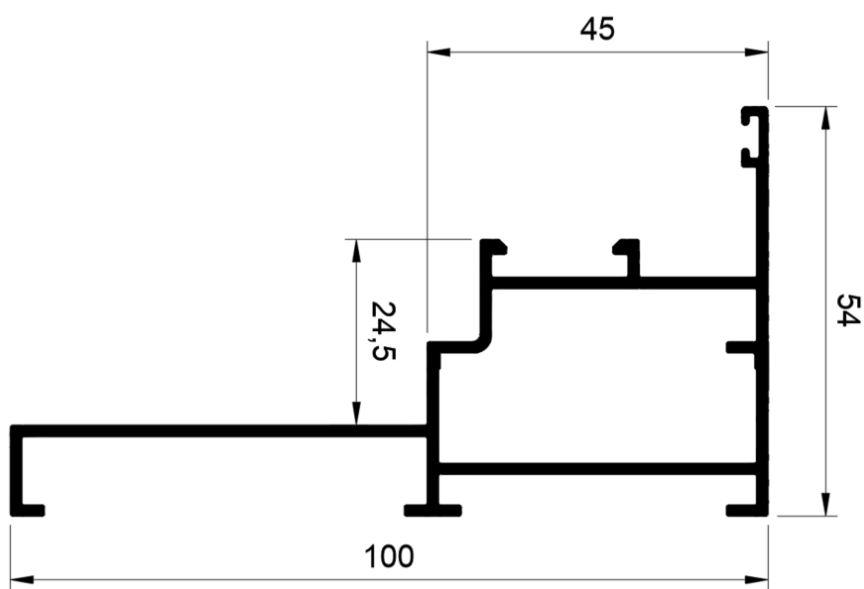
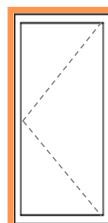

45EC - 250

Travessa para Porta de Giro
1,545 Kg/m

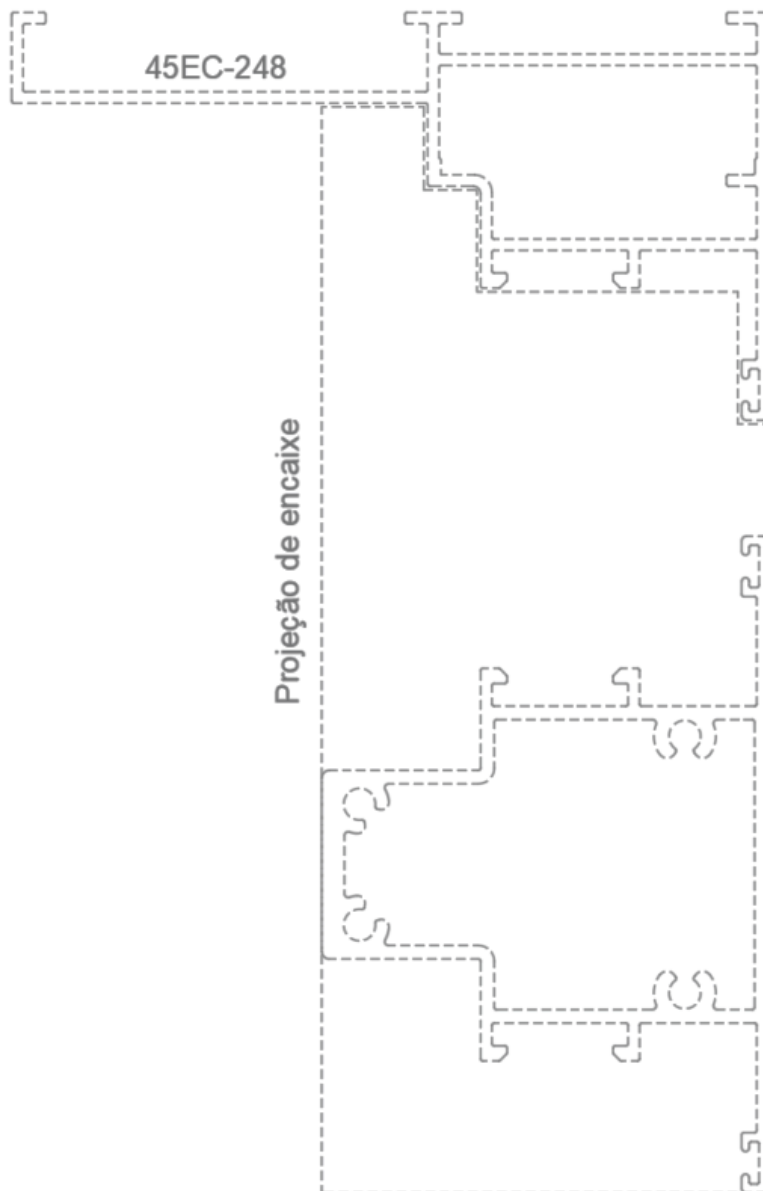
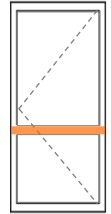
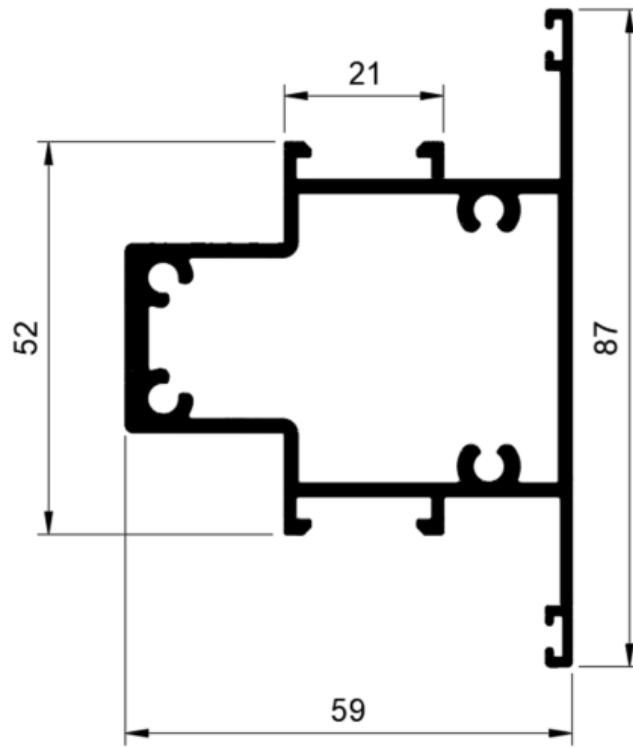

*dimensões em milímetros

45EC - 253

Largura Inferior da Porta de Giro
2,247 Kg/m

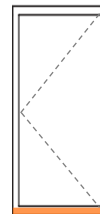
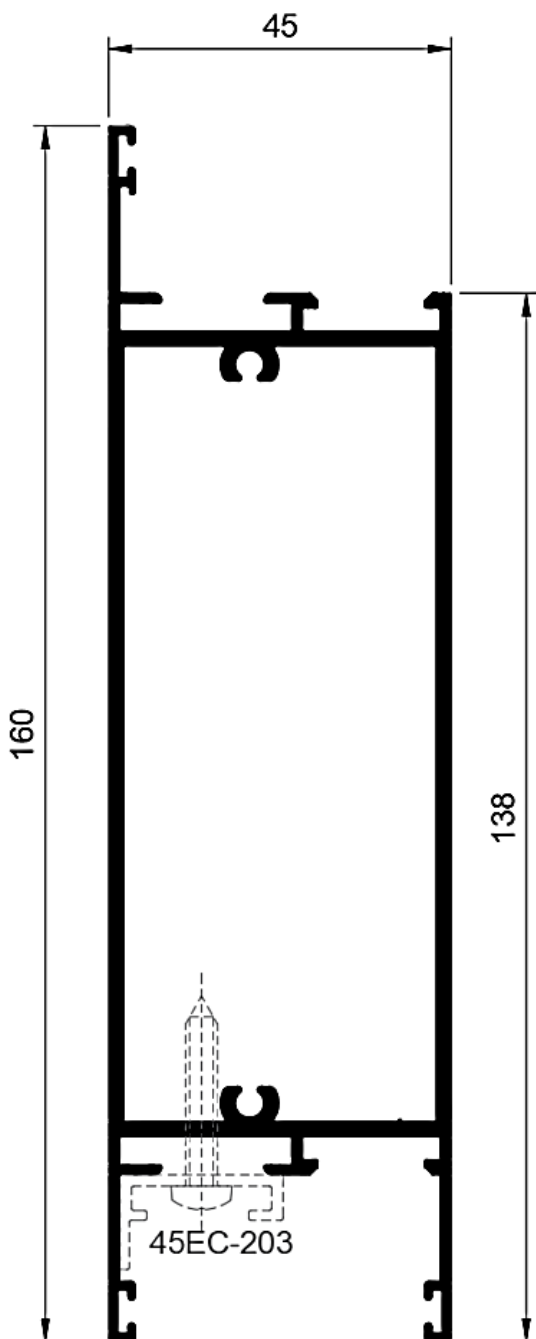

45EC - 203

Complemento Largura Inferior da Porta de Giro
0,162 Kg/m

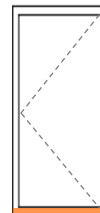
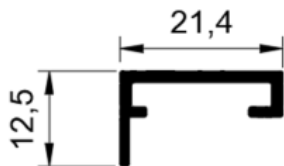

ECBG - 213

Baguete
0,278 Kg/m

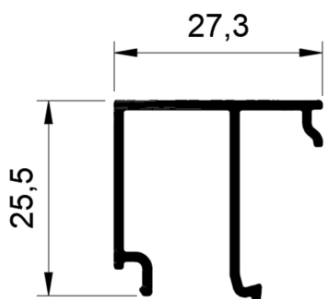
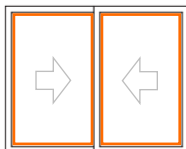

ECBG - 214

Baguete
0,274 Kg/m

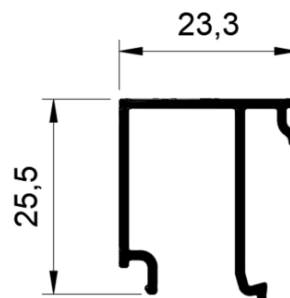
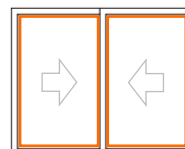

ECBG - 215

Baguete
0,261 Kg/m

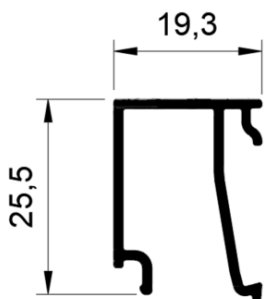
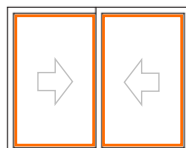

ECBG - 216

Baguete
0,234 Kg/m

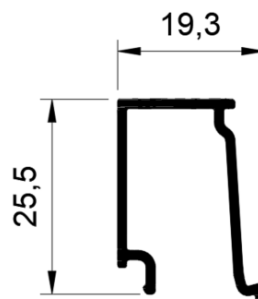
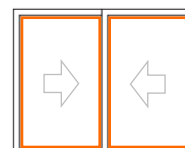

ECBG - 217

Baguete
0,227 Kg/m

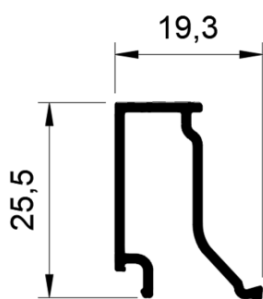
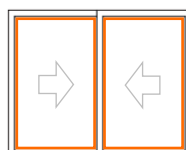

ECBG - 218

Baguete
0,185 Kg/m

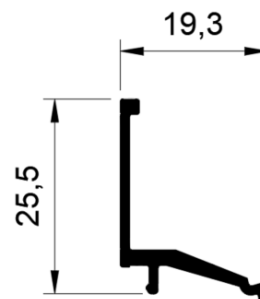
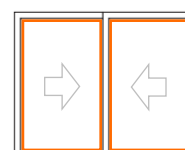

INTEGRADA

CPU - 402

Marco Superior da Integrada
1,508 Kg/m

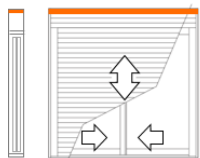
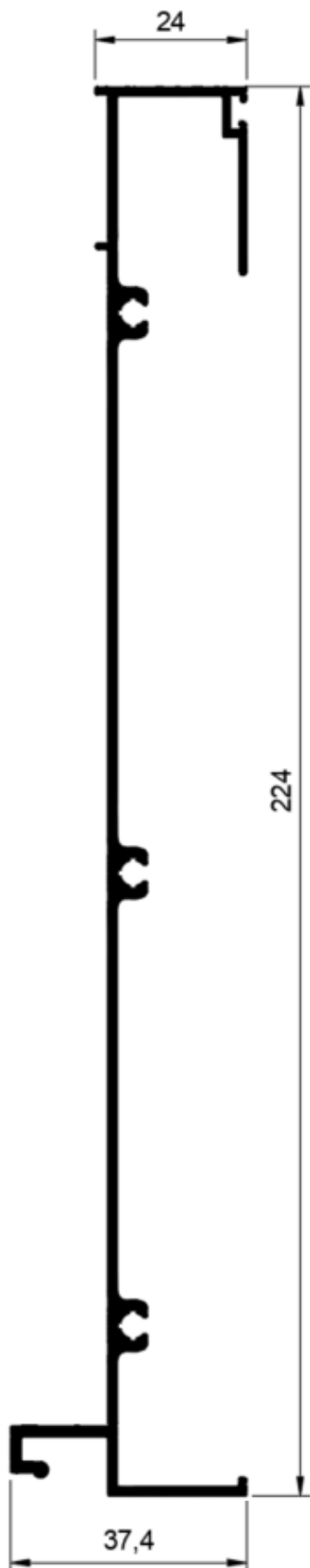

CPU - 403

Tampa Externa da Integrada
1,280 Kg/m

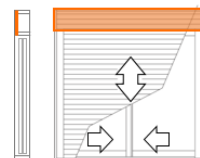
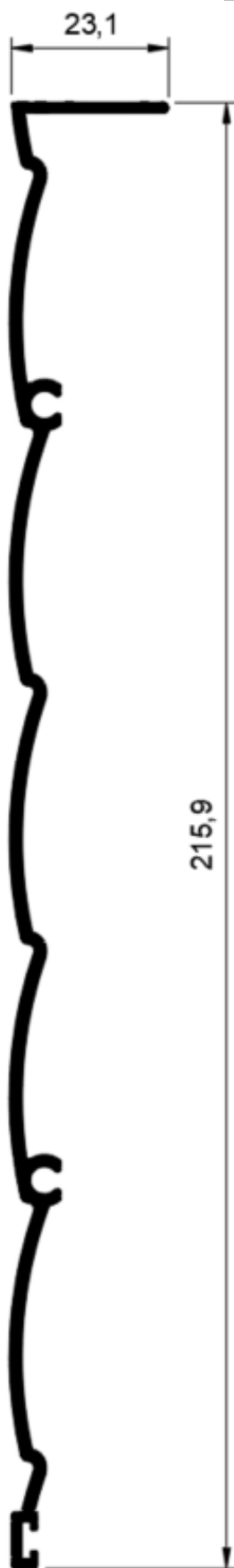

*dimensões em milímetros

CPU - 401

Marco Lateral da Integrada
1,220 Kg/m

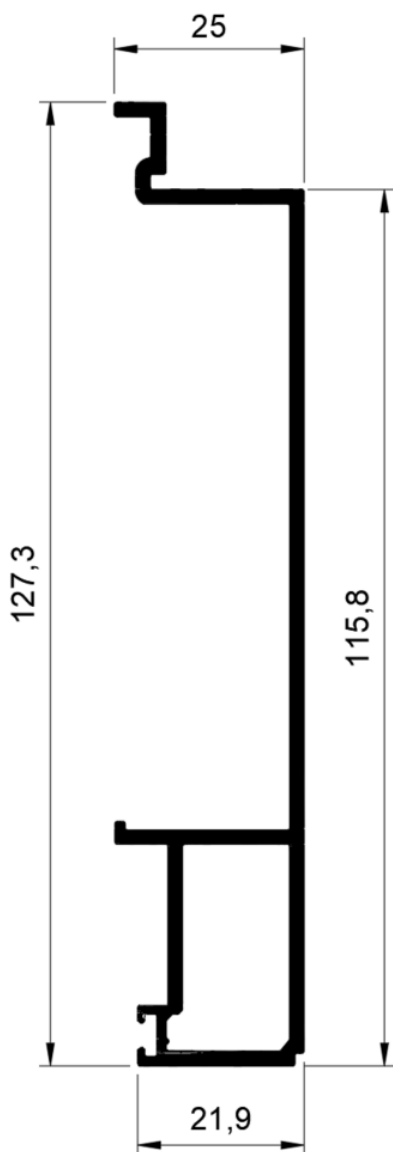
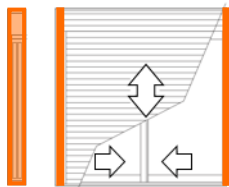

CPU - 404

Tampa Interna da Integrada
1,665 Kg/m

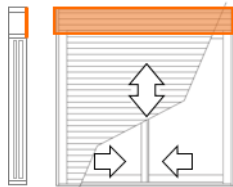

CPU - 405

Marco Intermediário da Integrada
0,963 Kg/m

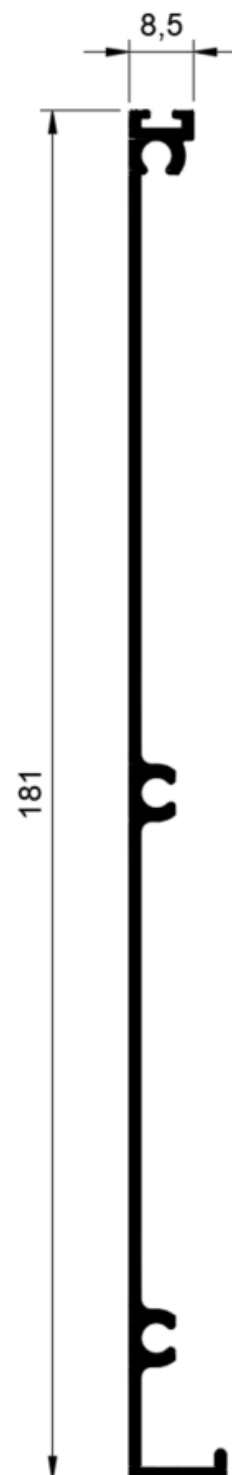
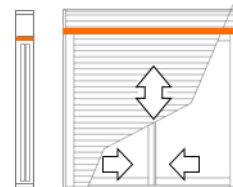

*dimensões em milímetros

SPI - 104

Guia Lateral
0,687 Kg/m

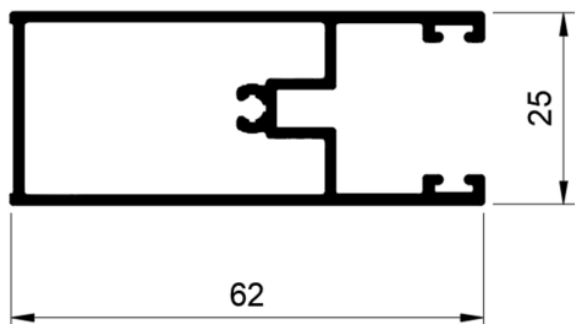
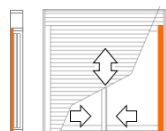

DS - 238

Tubo da Persiana
0,521 Kg/m

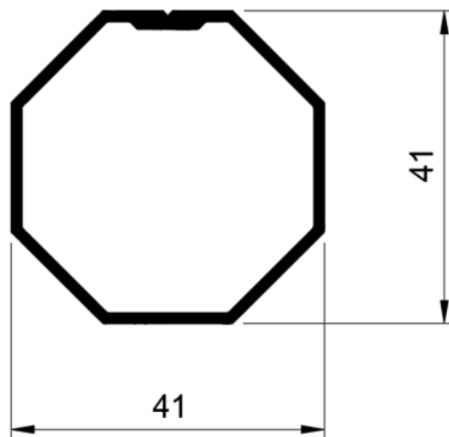

MN - 055

Terminal da Persiana
0,371 Kg/m

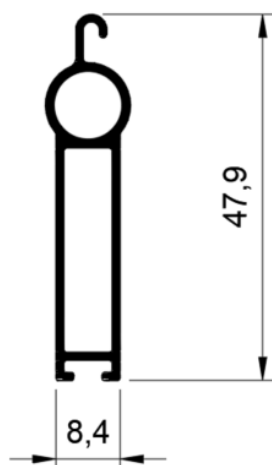



MN - 015

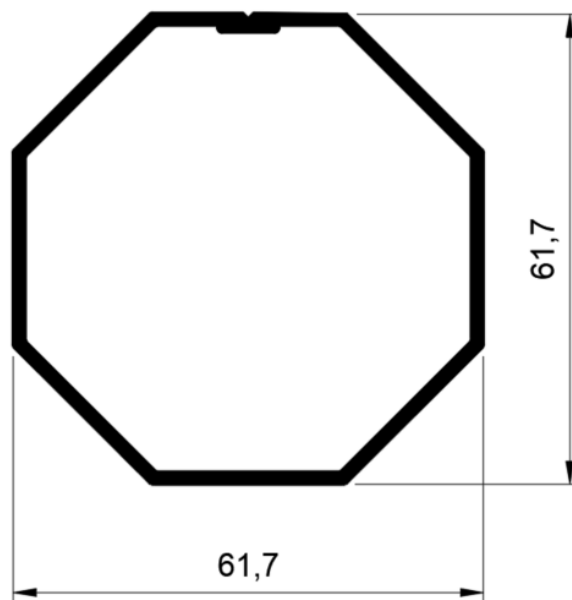



Tubo da Persiana
0,881 Kg/m

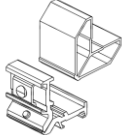
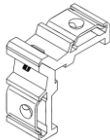
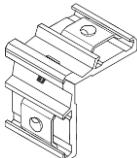

*dimensões em milímetros

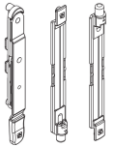
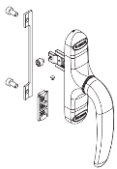
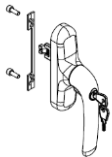
ACESSÓRIO	CÓDIGO	CÓDIGO UNIVERSAL	DESCRIÇÃO
	COS-03524	BARR10000	Vareta de Poliamida
	COS-02979	BATD10013	Batedeira
	COS-08349	BRAC10008NAT	Braço GS HD – 10
	COS-08350	BRAC10009NAT	Braço GS HD – 16
	COS-08351	BRAC10010NAT	Braço GS HD – 22
	COS-08352	BRAC10011NAT	Braço GS HD – 28
	COS-08194	BRAC10013INX	Braço GS HD – 24
	COS-01971	CALC10004PTO	Calço para Braço
	COS-07681	CILD10006NAT	Cilindro
	COS-04630	CONT10006NAT	Contra Fecho
	81.39025.135	81.39025.135	Conexão Anudal

ACESSÓRIO	CÓDIGO	CÓDIGO UNIVERSAL	DESCRIÇÃO
	COS-00340	CONX10012NAT	Conexão Kamel
	COS-00348	CONX10013NAT	Conexão Folha
	COS-00349	CONX10014NAT	Conexão Kamel
	COS-00350	CONX10015NAT	Conexão de Canto para a Folha
	COS-02921	CONX10016NAT	Conexão de Alinhamento
	COS-00357	CONX10038NAT	Conexão Kamel
	COS-00681	DOBR10006	Dobradiça Flash
	COS-02938	DREN10000	Par de Tampas para Pingadeira
	COS-07058N	ESPL00951	Roseta
	COS-04627	FDRA10011NAT	Fechadura
	COS-01164N	FECH01098	Cremona Única

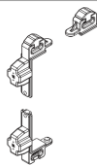
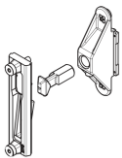
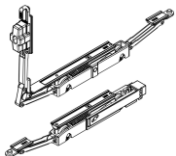
ACESSÓRIO	CÓDIGO	CÓDIGO UNIVERSAL	DESCRIÇÃO
	COS-02191N	FECH01090NAT	Fecho unha 2° Folha
	COS-01039	FECH01089	Cremona Prima s/ chave
	COS-01091	FECH01089	Cremona Prima c/ chave
	GUA-410	GUAR00410PTO	Guarnição Folha e Marco
	GUA-412	GUAR00412PTO	Guarnição Vidro
	GUA-413	GUAR00413PTO	Guarnição Vidro
	COS-02970	GUAR10035PTO	Gaxeta
	COS-02933	KTTP10012	Kit de Adaptadores para Batedeira
	COS-02929	KTFC10000NAT	Kit para Fechamento GOS-S
	ROL-03913	KTRD10000NAT	Kit Roldana de 90 a 200 Kg

ACESSÓRIO	CÓDIGO	CÓDIGO UNIVERSAL	DESCRIÇÃO
	COS-02974	VEDA10017NAT	Espuma selante para trilhos planos
	COS-02975	VEDA10018NAT	Espuma selante para trilhos planos
	ROL-03916	KTRD10001NAT	Kit Roldana até 90 Kg
	COS-02939	KTTP10001NAT	Kit de Adaptadores para Batedeira
	COS-02945	COS-02945	Kit de Adaptadores GOS-S
	COS-04099	KTTR00625NAT	Dispositivo de Ligação
			Vareta-Cremona
	COS-02792	MACN10000	Maçaneta Prima Plus
	COS-02908	MACN10010	Cremona Martelina Longo
	COS-02942	MACN10011	Fecho de Embutir para Janelas
	COS-02948	MACN10012	Cremona Martelina Curto

ACESSÓRIO	CÓDIGO	CÓDIGO UNIVERSAL	DESCRIÇÃO
	COS-06745	NYLO00485PTO	Calço para Vidro de 5 mm
	COS-06746	NYLO00486PTO	Calço para Vidro de 2 mm
	COS-00645	SUPT10009NAT	Placa para perfil inversor
	COS-02947	TAMP10033PTO	Adaptadores para duas folhas
	COS-04027K	TRAV00015FCO	Botão para pontos de fechamento
	COS-02954	TRAV10010NAT	GOS-S Kit para folha fixa
	COS-01353K	TRAV00020NAT	Complemento do fecho
	COS-02951	TRAV10016NAT	Mecanismo da Cremona
	COS-04020K	TRAV10017NAT	Reenvio de ângulo

ECBG - 213

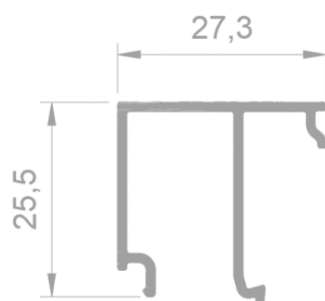

DETALHES		Espessura Vidro (mm)	Guarnição Interna	Guarnição Externa
45EC-247		4	GUA412	GUA414
		5	GUA411	GUA414
		6	GUA412	GUA413
		7	GUA411	GUA413
45EC-234		4	GUA412	GUA414
		5	GUA411	GUA414
		6	GUA412	GUA413
		7	GUA411	GUA413
45EC-251		4	GUA412	GUA414
		5	GUA411	GUA414
		6	GUA412	GUA413
		7	GUA411	GUA413
45EC-268		4	GUA412	GUA414
		5	GUA411	GUA414
		6	GUA412	GUA413
		7	GUA411	GUA413

*dimensões em milímetros

TABELA DE VIDROS

ECBG - 214

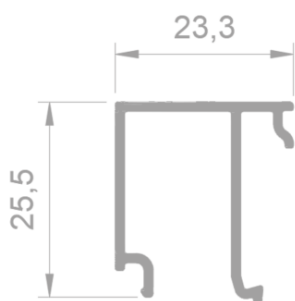

DETALHES		Espessura Vidro (mm)	Guarnição Interna	Guarnição Externa
45EC-247		8	GUA412	GUA414
		9	GUA411	GUA414
		10	GUA412	GUA413
		11	GUA411	GUA413
45EC-234		8	GUA412	GUA414
		9	GUA411	GUA414
		10	GUA412	GUA413
		11	GUA411	GUA413
45EC-251		8	GUA412	GUA414
		9	GUA411	GUA414
		10	GUA412	GUA413
		11	GUA411	GUA413
45EC-268		8	GUA412	GUA414
		9	GUA411	GUA414
		10	GUA412	GUA413
		11	GUA411	GUA413

*dimensões em milímetros

ECBG - 215

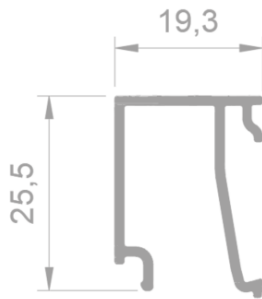

DETALHES		Espessura Vidro (mm)	Guarnição Interna	Guarnição Externa
45EC-247		12	GUA412	GUA414
		13	GUA411	GUA414
		14	GUA412	GUA413
		15	GUA411	GUA413
45EC-234		12	GUA412	GUA414
		13	GUA411	GUA414
		14	GUA412	GUA413
		15	GUA411	GUA413
45EC-251		12	GUA412	GUA414
		13	GUA411	GUA414
		14	GUA412	GUA413
		15	GUA411	GUA413
45EC-268		12	GUA412	GUA414
		13	GUA411	GUA414
		14	GUA412	GUA413
		15	GUA411	GUA413

*dimensões em milímetros

TABELA DE VIDROS

ECBG - 216

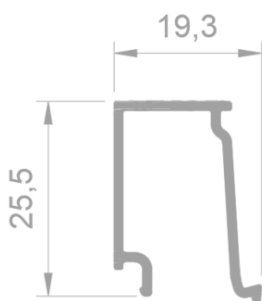

DETALHES		Espessura Vidro (mm)	Guarnição Interna	Guarnição Externa
45EC-247		16	GUA412	GUA414
		17	GUA411	GUA414
		18	GUA412	GUA413
		19	GUA411	GUA413
45EC-234		16	GUA412	GUA414
		17	GUA411	GUA414
		18	GUA412	GUA413
		19	GUA411	GUA413
45EC-251		16	GUA412	GUA414
		17	GUA411	GUA414
		18	GUA412	GUA413
		19	GUA411	GUA413
45EC-268		16	GUA412	GUA414
		17	GUA411	GUA414
		18	GUA412	GUA413
		19	GUA411	GUA413

*dimensões em milímetros

ECBG - 217

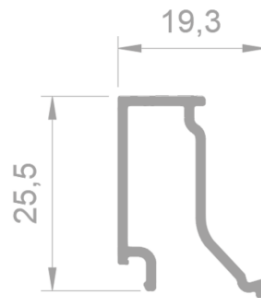

DETALHES		Espessura Vidro (mm)	Guarnição Interna	Guarnição Externa
45EC-247		20	GUA412	GUA414
		21	GUA411	GUA414
		22	GUA412	GUA413
		23	GUA411	GUA413
45EC-234		20	GUA412	GUA414
		21	GUA411	GUA414
		22	GUA412	GUA413
		23	GUA411	GUA413
45EC-251		20	GUA412	GUA414
		21	GUA411	GUA414
		22	GUA412	GUA413
		23	GUA411	GUA413
45EC-268		20	GUA412	GUA414
		21	GUA411	GUA414
		22	GUA412	GUA413
		23	GUA411	GUA413

*dimensões em milímetros

TABELA DE VIDROS

ECBG - 218

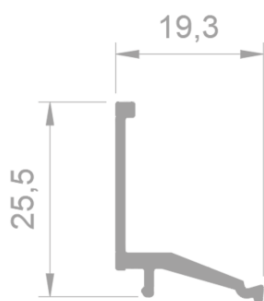

DETALHES		Espessura Vidro (mm)	Guarnição Interna	Guarnição Externa
45EC-247		28	GUA412	GUA414
		30	GUA412	GUA413
		32	GUA411	GUA413
45EC-234		28	GUA412	GUA414
		30	GUA412	GUA413
		32	GUA411	GUA413
45EC-251		28	GUA412	GUA414
		30	GUA412	GUA413
		32	GUA411	GUA413
45EC-268		28	GUA412	GUA414
		30	GUA412	GUA413
		32	GUA411	GUA413

*dimensões em milímetros

Janelas de 02, 03, 04 e 06 folhas de correr

Opcionais: Persiana Integrada, Basculante Superior e/ou Inferior, Venezianas

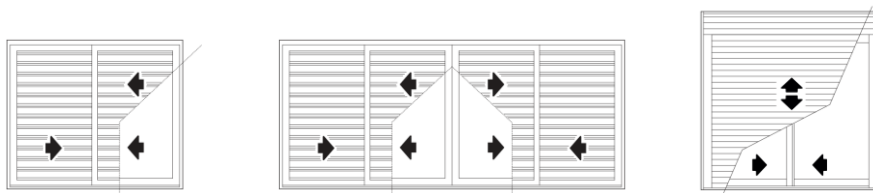
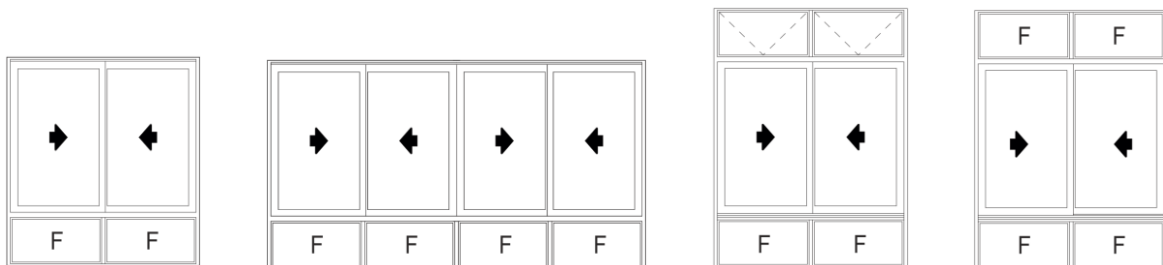
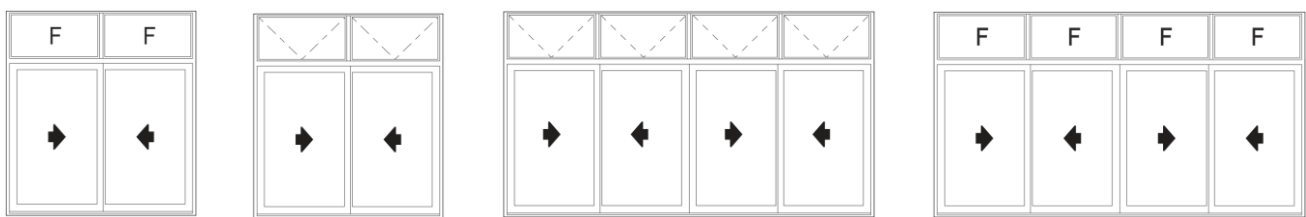
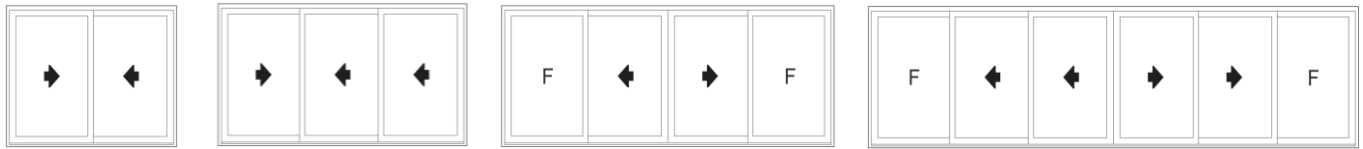

Portas de 02, 03, 04 e 06 folhas de correr

Opcionais: Persiana Integrada, Basculante Superior, Venezianas

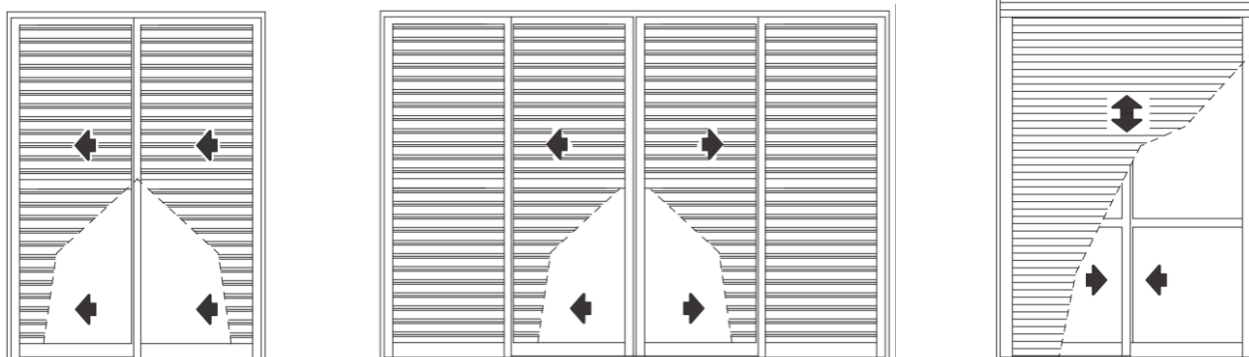
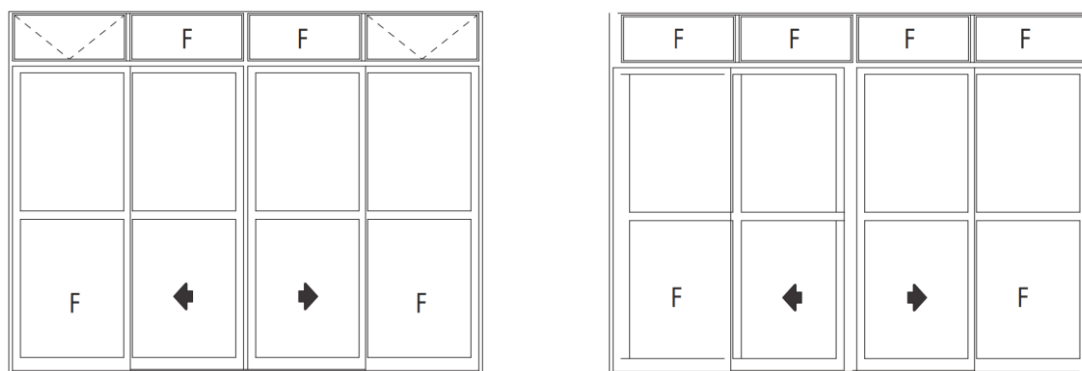
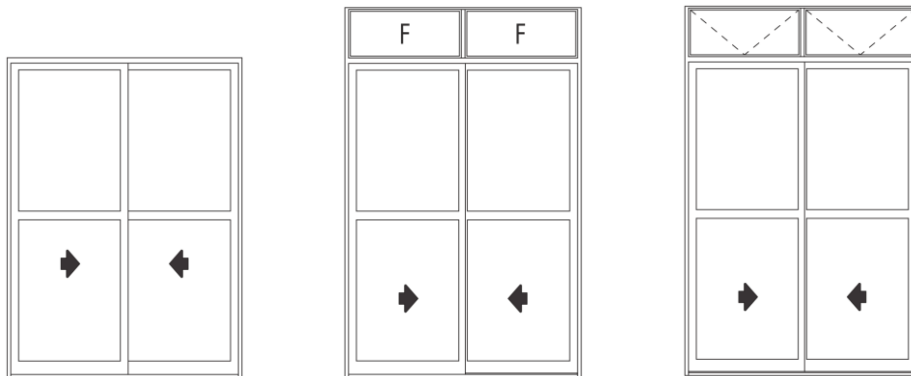

Maxim-ar

Fixo, Inferior, Superior e Múltiplo

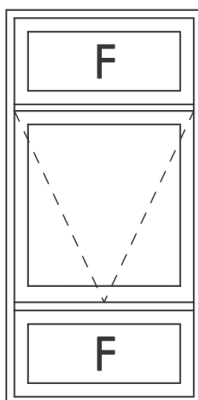
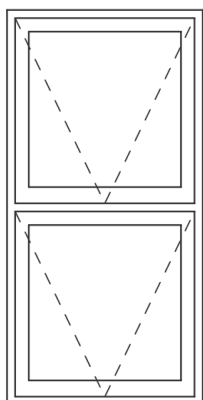
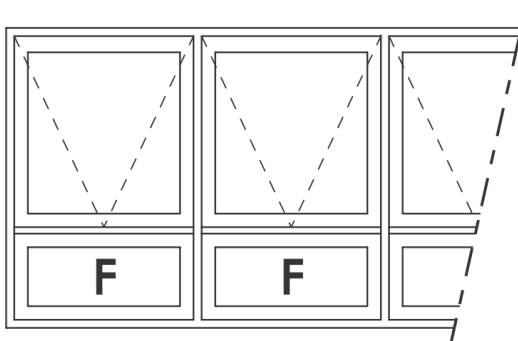
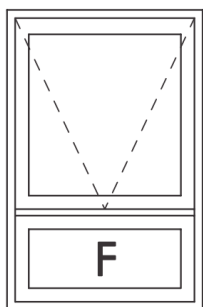
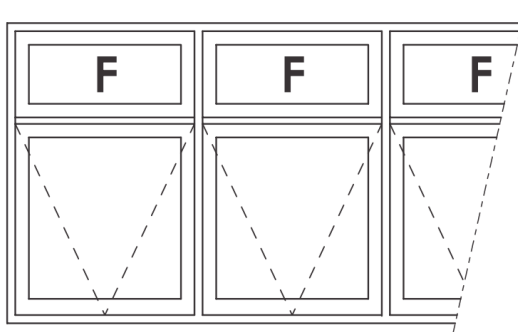
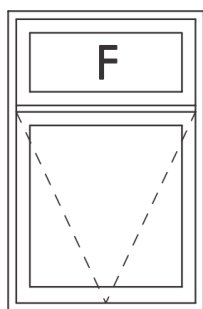
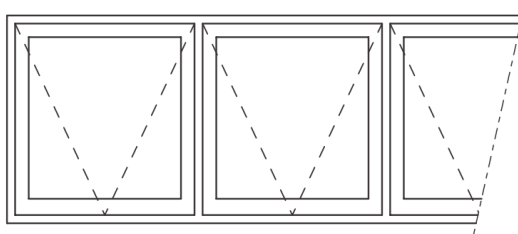
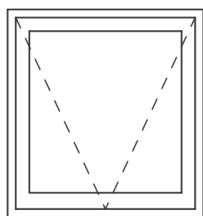

No Brasil, o comportamento de uma esquadria está regulamentado pela Norma **ABNT NBR 10.821**. Esta norma determina os parâmetros de desempenho mínimas de caixilhos em edificações residenciais e comerciais.

A velocidade do vento é o fator inicial para calcular a pressão do vento no local desejado.

Isopletas dos Ventos
(em metros por segundo)

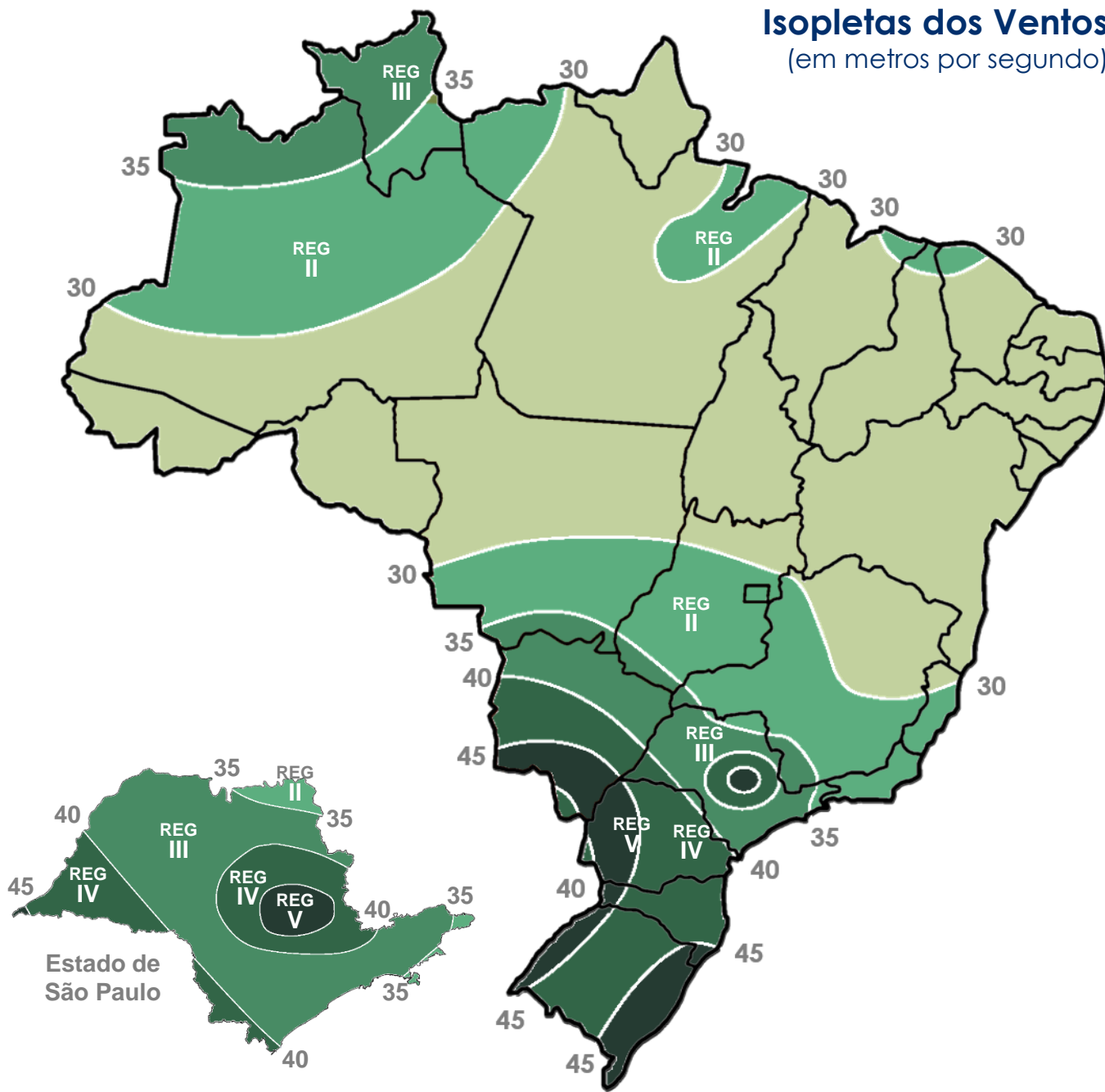

VELOCIDADE DO VENTO POR REGIÃO CONSIDERADA NA NORMA ABNT NBR 10.821

REGIÃO 1	REGIÃO 2	REGIÃO 3	REGIÃO 4	REGIÃO 5
até 30 m/s até 108 km/h	30 - 35 m/s 108 - 126 km/h	35 - 40 m/s 126 - 144 km/h	40 - 45 m/s 144 - 162 km/h	45 - 50 m/s 162 - 180 km/h

*dimensões em milímetros

NORMAS

QUANTIDADE DE PAVIMENTOS	ALTURA MÁXIMA	REGIÕES DO PAÍS	PRESSÃO DO ENSAIO	PRESSÃO DE SEGURANÇA	PRESSÃO DE ÁGUA
			Pe em (Pa) Positiva e negativa Pe – Pp x 1,2	Ps em (Pa) Positiva e negativa Ps – Pp x 1,5	Pa em (Pa) Positiva e negativa Pa – Pp x 0,2
02	6 m	I	350	520	60
		II	470	700	80
		III	610	920	100
		IV	770	1160	130
		V	950	1430	160
05	15 m	I	420	640	70
		II	580	860	100
		III	750	1130	130
		IV	950	1430	160
		V	1180	1780	200
10	30 m	I	500	750	80
		II	680	1030	110
		III	890	1340	150
		IV	1130	1700	190
		V	1400	2090	230
20	60 m	I	600	900	100
		II	815	1220	140
		III	1060	1600	180
		IV	1350	2020	220
		V	1660	2500	280
30	90 m	I	660	980	110
		II	890	1340	150
		III	1170	1750	200
		IV	1480	2210	250
		V	1820	2730	300

DIAGRAMA DE DIMENSÕES

JANELAS DE CORRER 2 FOLHAS

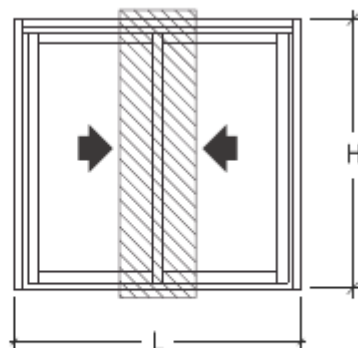
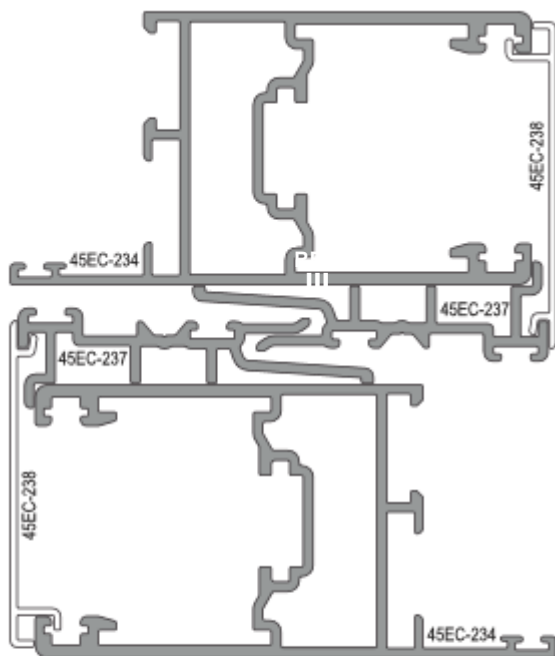

45EC-234	45EC-237	45EC-234	45EC-237
$Jx = 17,252 \text{ cm}^4$	$Jx = 0,218 \text{ cm}^4$	$Jx = 17,252 \text{ cm}^4$	$Jx = 0,218 \text{ cm}^4$
$Jy = 24,748 \text{ cm}^4$	$Jy = 5,461 \text{ cm}^4$	$Jy = 24,748 \text{ cm}^4$	$Jy = 5,461 \text{ cm}^4$
$Wx = 7,146 \text{ cm}^3$	$Wx = 0,221 \text{ cm}^3$	$Wx = 7,146 \text{ cm}^3$	$Wx = 0,221 \text{ cm}^3$
$Wy = 5,194 \text{ cm}^3$	$Wy = 1,640 \text{ cm}^3$	$Wy = 5,194 \text{ cm}^3$	$Wy = 1,640 \text{ cm}^3$
Jx Total = 34,940 cm⁴		(perfil 45EC-238 não considerado no cálculo)	



DIAGRAMA DE DIMENSÕES

JANELAS DE CORRER 2 FOLHAS



45EC-234	45EC-237	45EC-239	45EC-234	45EC-237	45EC-239
$J_x = 17,252 \text{ cm}^4$	$J_x = 0,218 \text{ cm}^4$	$J_x = 7,341 \text{ cm}^4$	$J_x = 17,252 \text{ cm}^4$	$J_x = 0,218 \text{ cm}^4$	$J_x = 7,341 \text{ cm}^4$
$J_y = 24,748 \text{ cm}^4$	$J_y = 5,461 \text{ cm}^4$	$J_y = 0,465 \text{ cm}^4$	$J_y = 24,748 \text{ cm}^4$	$J_y = 5,461 \text{ cm}^4$	$J_y = 0,465 \text{ cm}^4$
$W_x = 7,146 \text{ cm}^3$	$W_x = 0,221 \text{ cm}^3$	$W_x = 3,598 \text{ cm}^3$	$W_x = 7,146 \text{ cm}^3$	$W_x = 0,221 \text{ cm}^3$	$W_x = 3,598 \text{ cm}^3$
$W_y = 5,194 \text{ cm}^3$	$W_y = 1,640 \text{ cm}^3$	$W_y = 0,628 \text{ cm}^3$	$W_y = 5,194 \text{ cm}^3$	$W_y = 1,640 \text{ cm}^3$	$W_y = 0,628 \text{ cm}^3$
$J_x \text{ Total} = 49,622 \text{ cm}^4$			(perfil 45EC-238 não considerado no cálculo)		

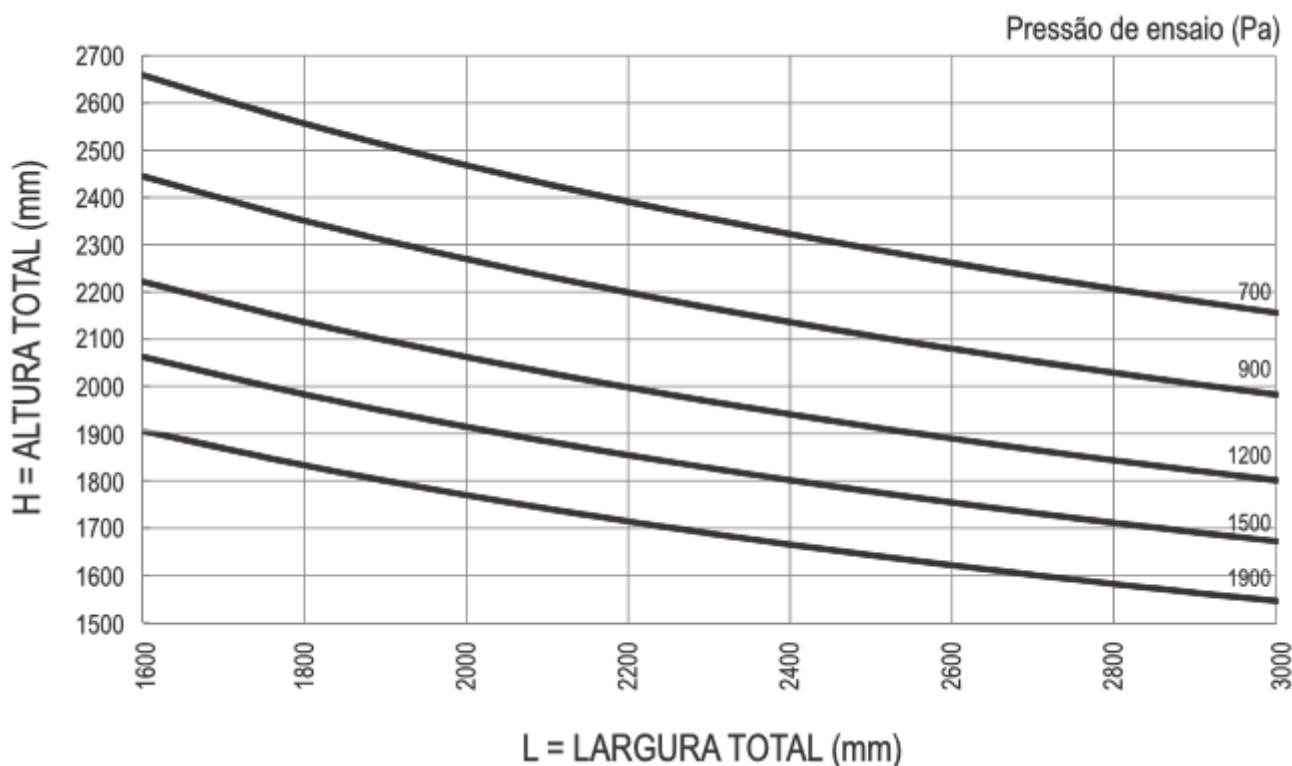
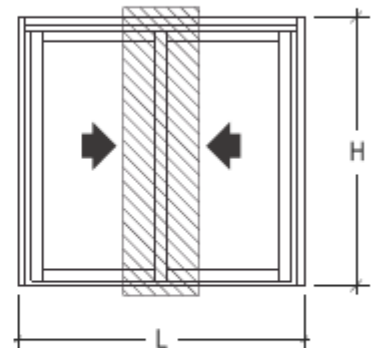
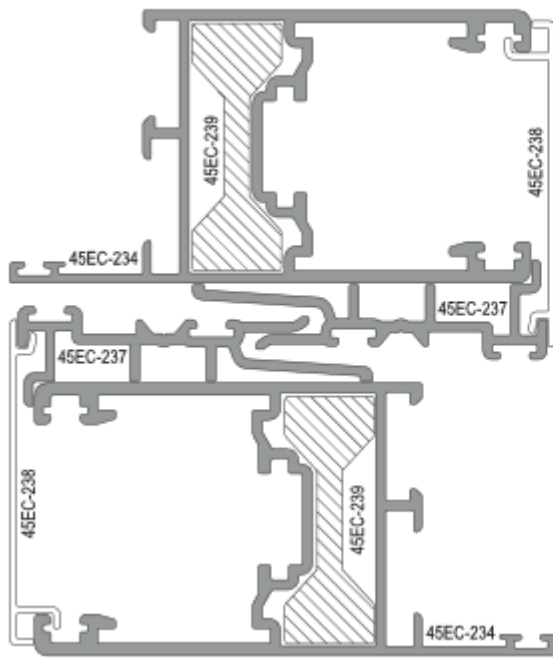

DIAGRAMA DE DIMENSÕES

PORTA DE CORRER 2 FOLHAS

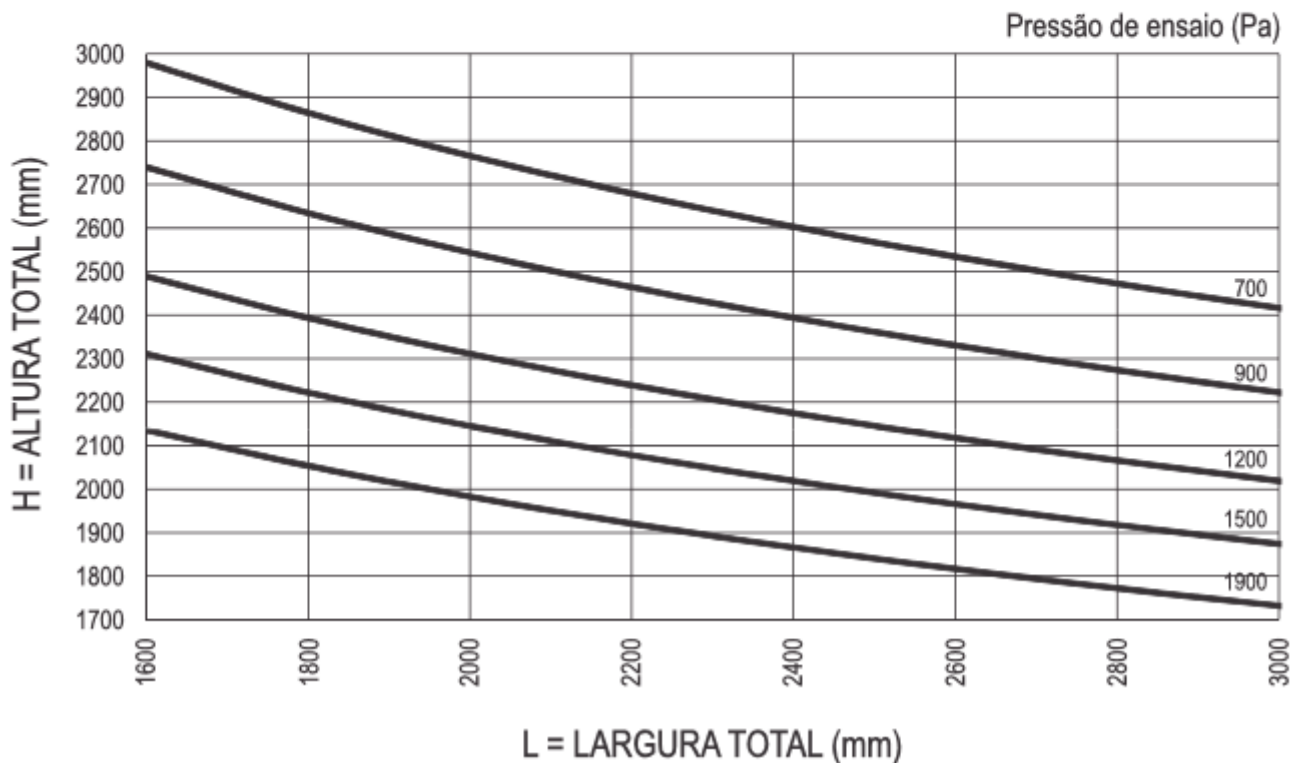
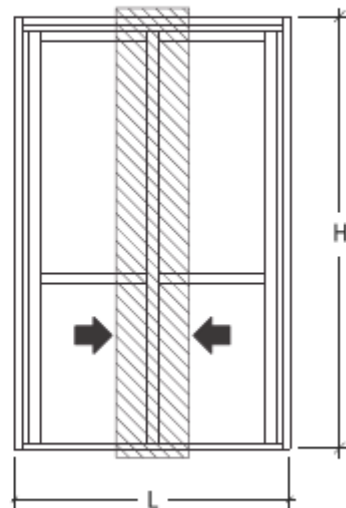
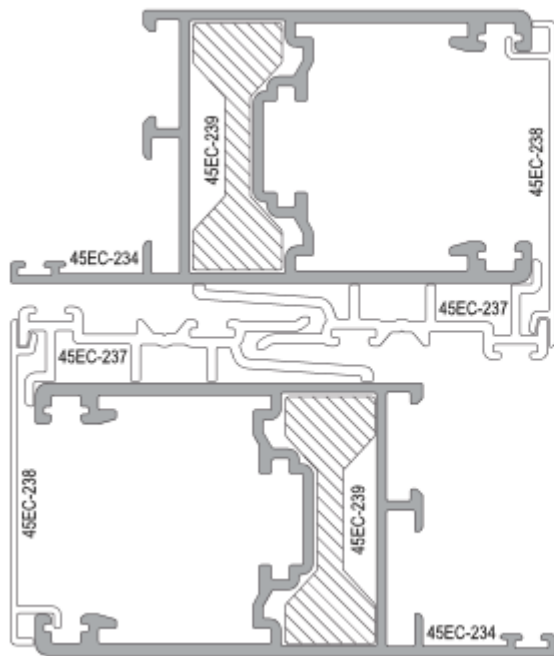

45EC-234	45EC-237	45EC-239	45EC-235	45EC-237	45EC-239
$J_x = 17,252 \text{ cm}^4$	$J_x = 0,218 \text{ cm}^4$	$J_x = 7,341 \text{ cm}^4$	$J_x = 40,823 \text{ cm}^4$	$J_x = 0,218 \text{ cm}^4$	$J_x = 7,341 \text{ cm}^4$
$J_y = 24,748 \text{ cm}^4$	$J_y = 5,461 \text{ cm}^4$	$J_y = 0,465 \text{ cm}^4$	$J_y = 28,022 \text{ cm}^4$	$J_y = 5,461 \text{ cm}^4$	$J_y = 0,465 \text{ cm}^4$
$W_x = 7,146 \text{ cm}^3$	$W_x = 0,221 \text{ cm}^3$	$W_x = 3,598 \text{ cm}^3$	$W_x = 10,089 \text{ cm}^3$	$W_x = 0,221 \text{ cm}^3$	$W_x = 3,598 \text{ cm}^3$
$W_y = 5,194 \text{ cm}^3$	$W_y = 1,640 \text{ cm}^3$	$W_y = 0,628 \text{ cm}^3$	$W_y = 6,354 \text{ cm}^3$	$W_y = 1,640 \text{ cm}^3$	$W_y = 0,628 \text{ cm}^3$

$J_x \text{ Total} = 73,193 \text{ cm}^4$

(perfil 45EC-235 não considerado no cálculo)



DIAGRAMA DE DIMENSÕES

JANELA/PORTA DE CORRER 2 FOLHAS



45EC-234	45EC-237	45EC-235	45EC-237
$J_x = 17,252 \text{ cm}^4$	$J_x = 0,218 \text{ cm}^4$	$J_x = 40,823 \text{ cm}^4$	$J_x = 0,218 \text{ cm}^4$
$J_y = 24,748 \text{ cm}^4$	$J_y = 5,461 \text{ cm}^4$	$J_y = 28,022 \text{ cm}^4$	$J_y = 5,461 \text{ cm}^4$
$W_x = 7,146 \text{ cm}^3$	$W_x = 0,221 \text{ cm}^3$	$W_x = 10,089 \text{ cm}^3$	$W_x = 0,221 \text{ cm}^3$
$W_y = 5,194 \text{ cm}^3$	$W_y = 1,640 \text{ cm}^3$	$W_y = 6,354 \text{ cm}^3$	$W_y = 1,640 \text{ cm}^3$
$J_x \text{ Total} = 58,511 \text{ cm}^4$		(perfil 45EC-238 não considerado no cálculo)	

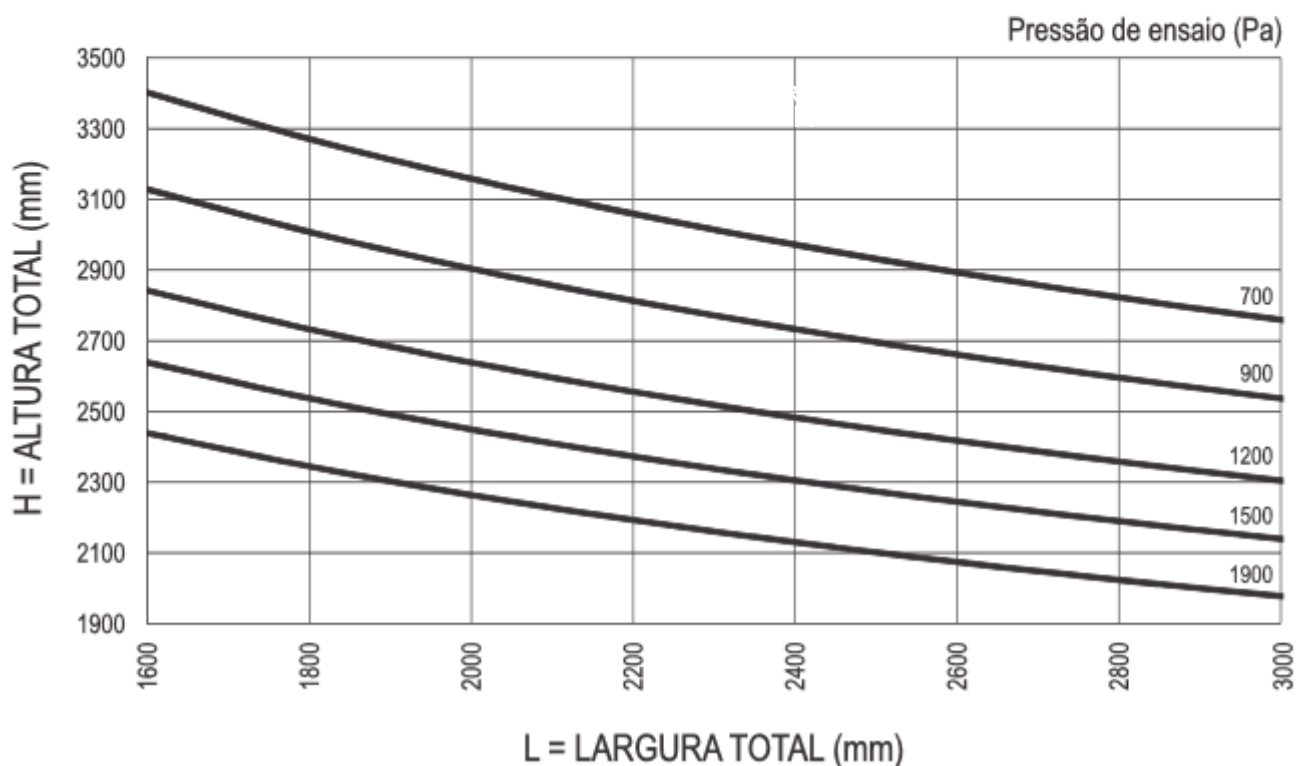
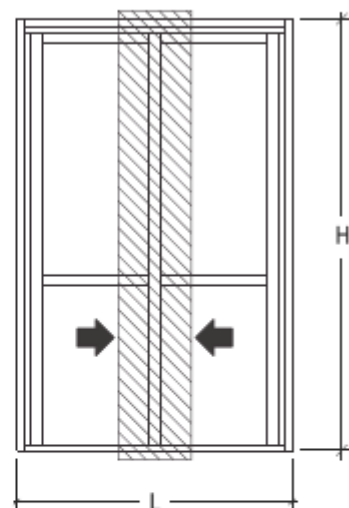
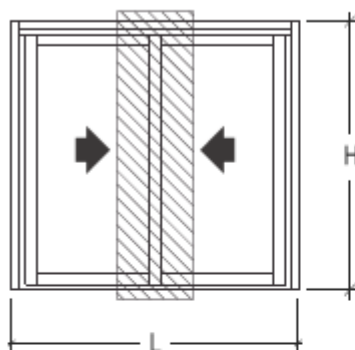
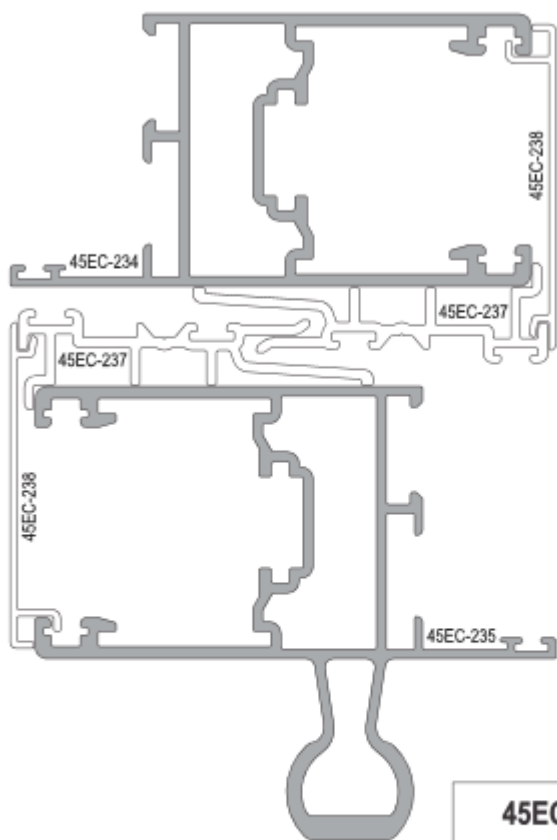

DIAGRAMA DE DIMENSÕES

PORTA DE CORRER 2 FOLHAS



45EC-236	45EC-237	45EC-235	45EC-237
$J_x = 44,580 \text{ cm}^4$	$J_x = 0,218 \text{ cm}^4$	$J_x = 40,823 \text{ cm}^4$	$J_x = 0,218 \text{ cm}^4$
$J_y = 28,022 \text{ cm}^4$	$J_y = 5,461 \text{ cm}^4$	$J_y = 28,022 \text{ cm}^4$	$J_y = 5,461 \text{ cm}^4$
$W_x = 10,396 \text{ cm}^3$	$W_x = 0,221 \text{ cm}^3$	$W_x = 10,089 \text{ cm}^3$	$W_x = 0,221 \text{ cm}^3$
$W_y = 6,354 \text{ cm}^3$	$W_y = 1,640 \text{ cm}^3$	$W_y = 6,354 \text{ cm}^3$	$W_y = 1,640 \text{ cm}^3$
$J_x \text{ Total} = 85,839 \text{ cm}^4$		(perfil 45EC-238 não considerado no cálculo)	

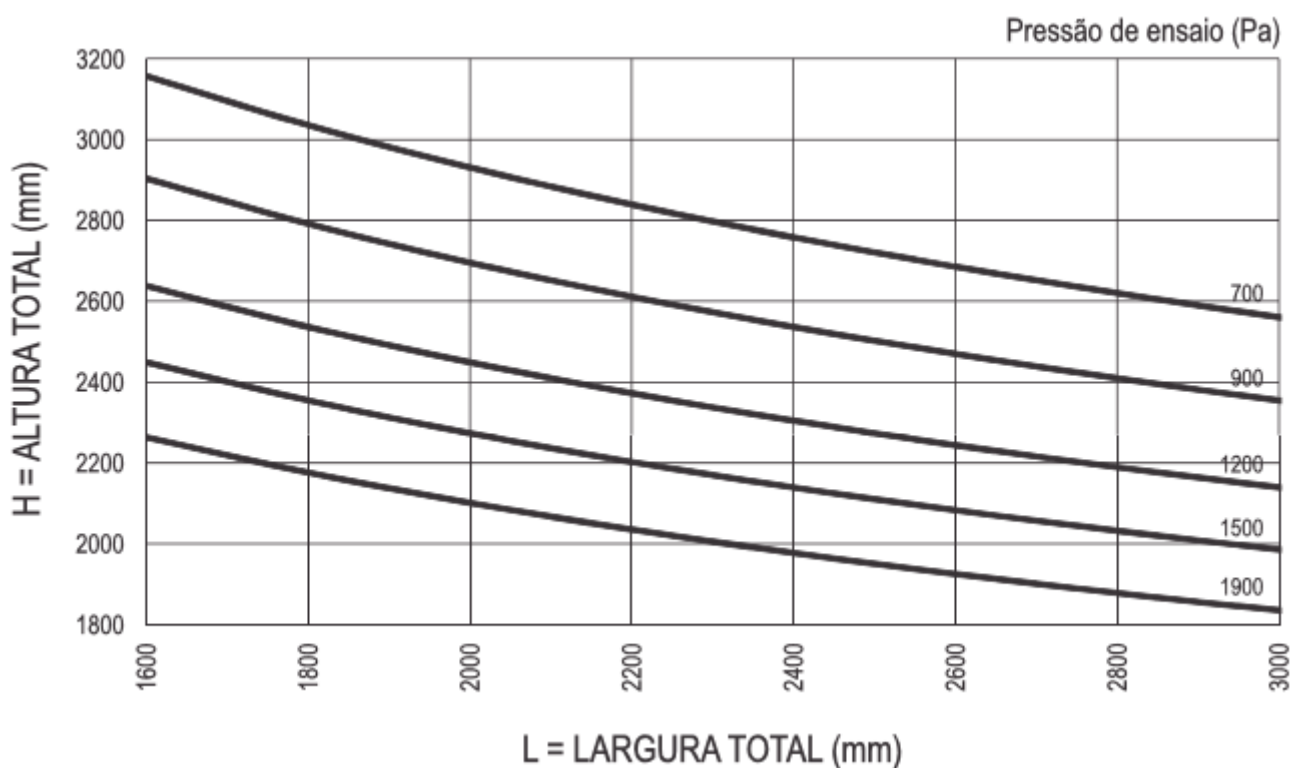
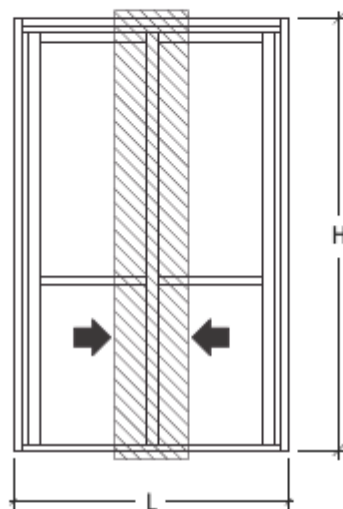
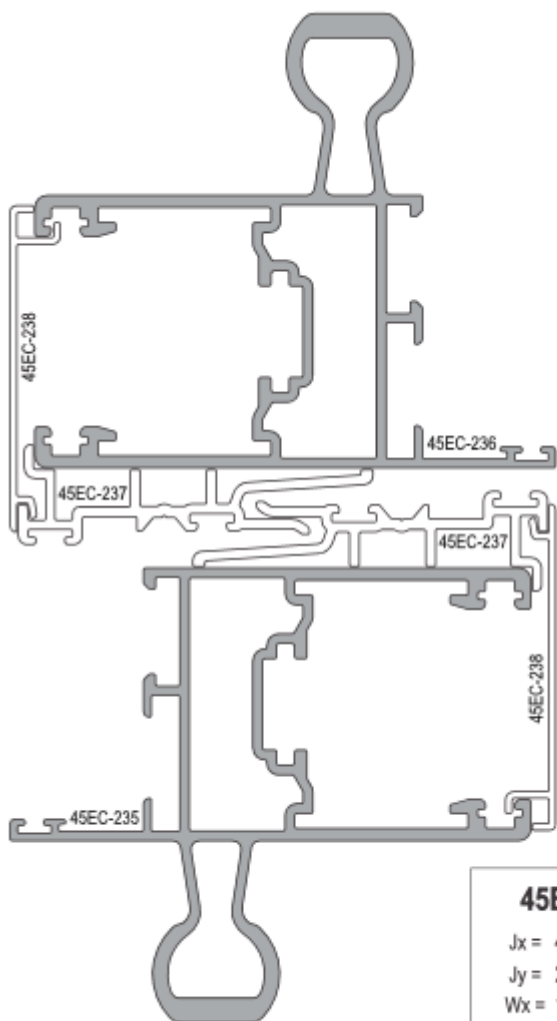

DIAGRAMA DE DIMENSÕES

PORTA DE CORRER 2 FOLHAS



45EC-236 $J_x = 44,580 \text{ cm}^4$ $J_y = 28,022 \text{ cm}^4$ $W_x = 10,396 \text{ cm}^3$ $W_y = 6,354 \text{ cm}^3$	45EC-237 $J_x = 0,218 \text{ cm}^4$ $J_y = 5,461 \text{ cm}^4$ $W_x = 0,221 \text{ cm}^3$ $W_y = 1,640 \text{ cm}^3$	45EC-239 $J_x = 7,341 \text{ cm}^4$ $J_y = 0,465 \text{ cm}^4$ $W_x = 3,598 \text{ cm}^3$ $W_y = 0,628 \text{ cm}^3$
45EC-235 $J_x = 40,823 \text{ cm}^4$ $J_y = 28,022 \text{ cm}^4$ $W_x = 10,089 \text{ cm}^3$ $W_y = 6,354 \text{ cm}^3$	45EC-237 $J_x = 0,218 \text{ cm}^4$ $J_y = 5,461 \text{ cm}^4$ $W_x = 0,221 \text{ cm}^3$ $W_y = 1,640 \text{ cm}^3$	45EC-239 $J_x = 7,341 \text{ cm}^4$ $J_y = 0,465 \text{ cm}^4$ $W_x = 3,598 \text{ cm}^3$ $W_y = 0,628 \text{ cm}^3$
Jx Total = 100,521 cm⁴ (perfil 45EC-238 não considerado no cálculo)		

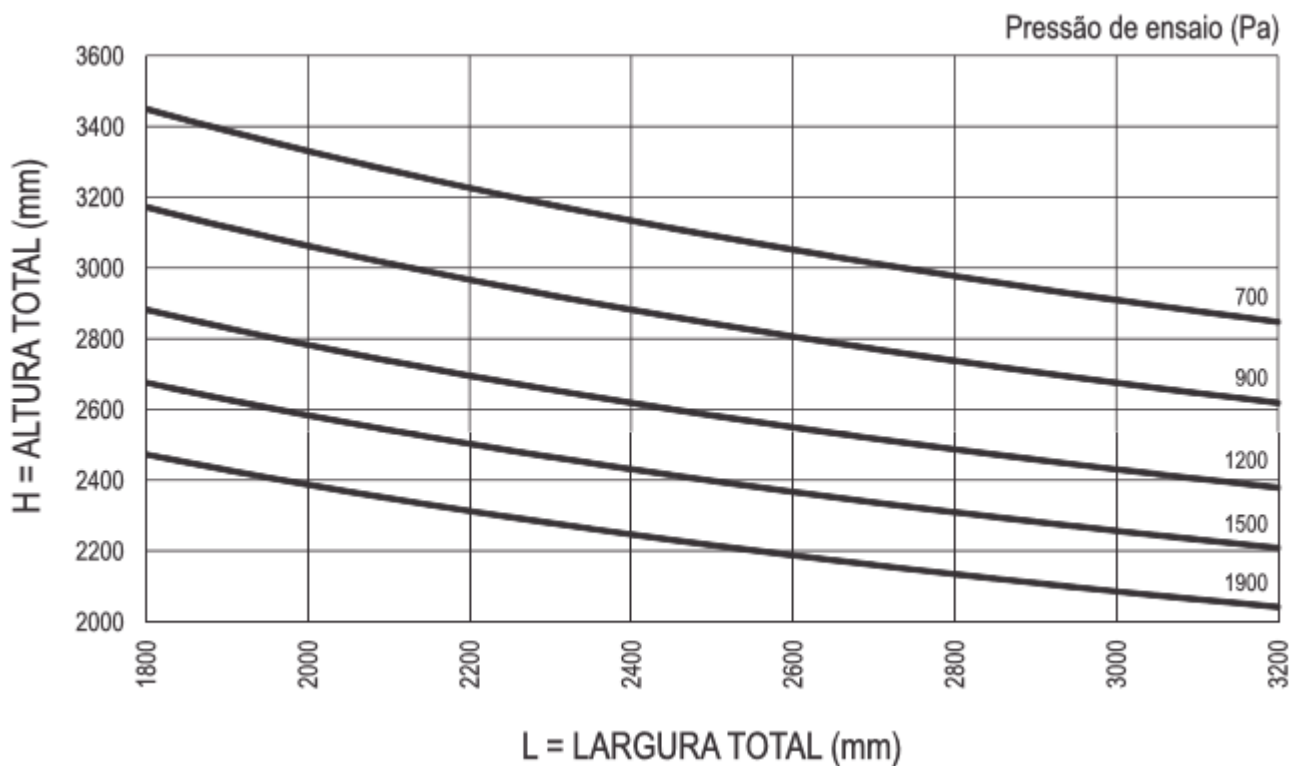
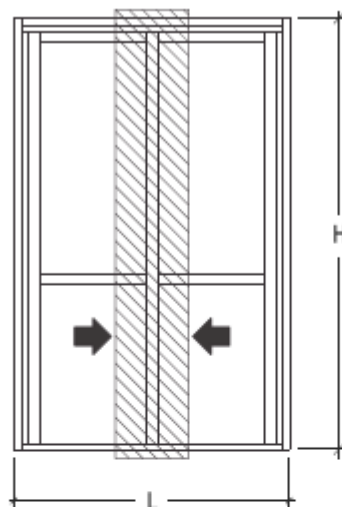
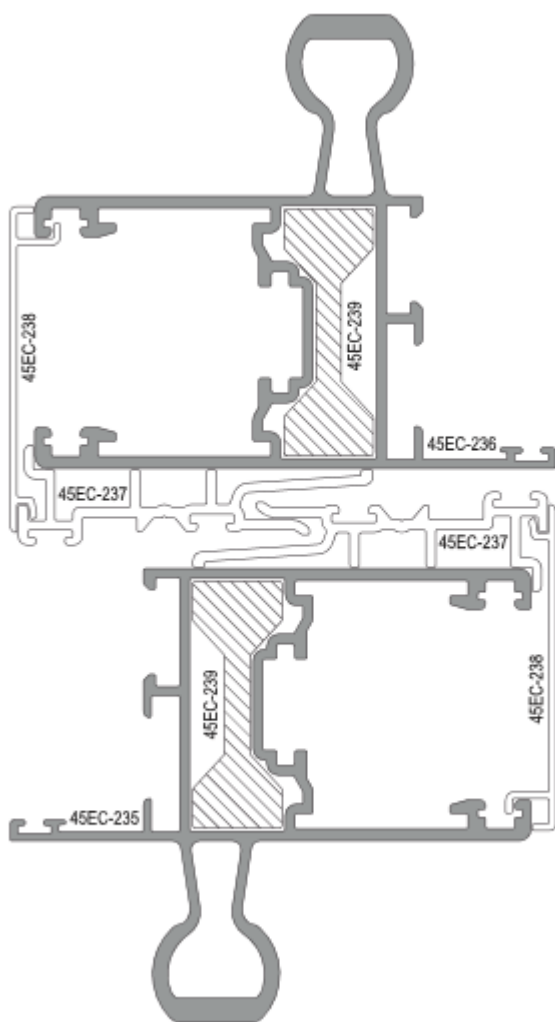

DIAGRAMA DE DIMENSÕES

PORTA DE CORRER 4 FOLHAS

<p>45EC-235</p> <p>Jx = 40,823 cm⁴ Jy = 28,022 cm⁴ Wx = 10,089 cm³ Wy = 6,354 cm³</p>	<p>45EC-239</p> <p>Jx = 7,341 cm⁴ Jy = 0,465 cm⁴ Wx = 3,598 cm³ Wy = 0,628 cm³</p>
<p>45EC-235</p> <p>Jx = 40,823 cm⁴ Jy = 28,022 cm⁴ Wx = 10,089 cm³ Wy = 6,354 cm³</p>	<p>45EC-239</p> <p>Jx = 7,341 cm⁴ Jy = 0,465 cm⁴ Wx = 3,598 cm³ Wy = 0,628 cm³</p>
<p>Jx Total = 96,328 cm⁴ (perfil 45EC-299 não considerado no cálculo)</p>	

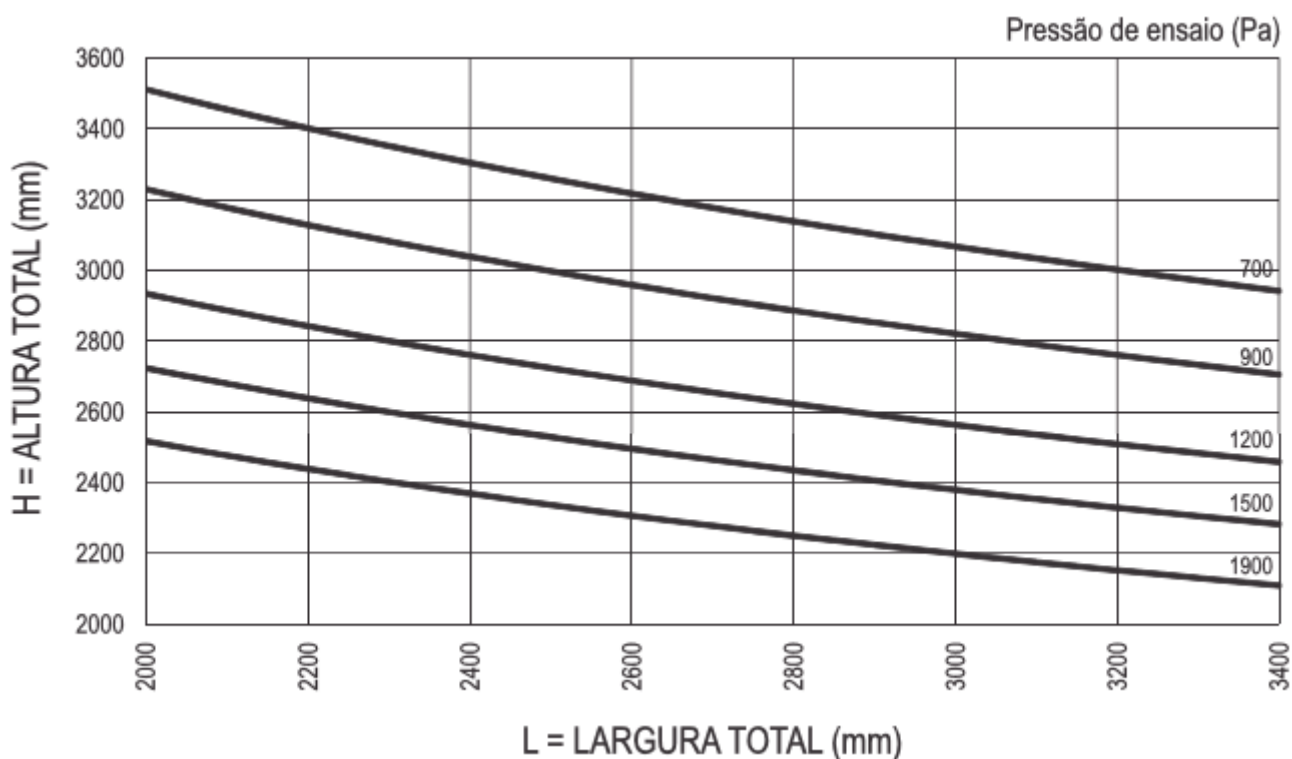

DIAGRAMA DE DIMENSÕES

JANELA DE CORRER 4 FOLHAS



45EC-234	45EC-239	45EC-234	45EC-239
$J_x = 17,252 \text{ cm}^4$	$J_x = 7,341 \text{ cm}^4$	$J_x = 17,252 \text{ cm}^4$	$J_x = 7,341 \text{ cm}^4$
$J_y = 24,748 \text{ cm}^4$	$J_y = 0,465 \text{ cm}^4$	$J_y = 24,748 \text{ cm}^4$	$J_y = 0,465 \text{ cm}^4$
$W_x = 7,146 \text{ cm}^3$	$W_x = 3,598 \text{ cm}^3$	$W_x = 7,146 \text{ cm}^3$	$W_x = 3,598 \text{ cm}^3$
$W_y = 5,194 \text{ cm}^3$	$W_y = 0,628 \text{ cm}^3$	$W_y = 5,194 \text{ cm}^3$	$W_y = 0,628 \text{ cm}^3$
$J_x \text{ Total} = 49,186 \text{ cm}^4$		(perfil 45EC-229 não considerado no cálculo)	

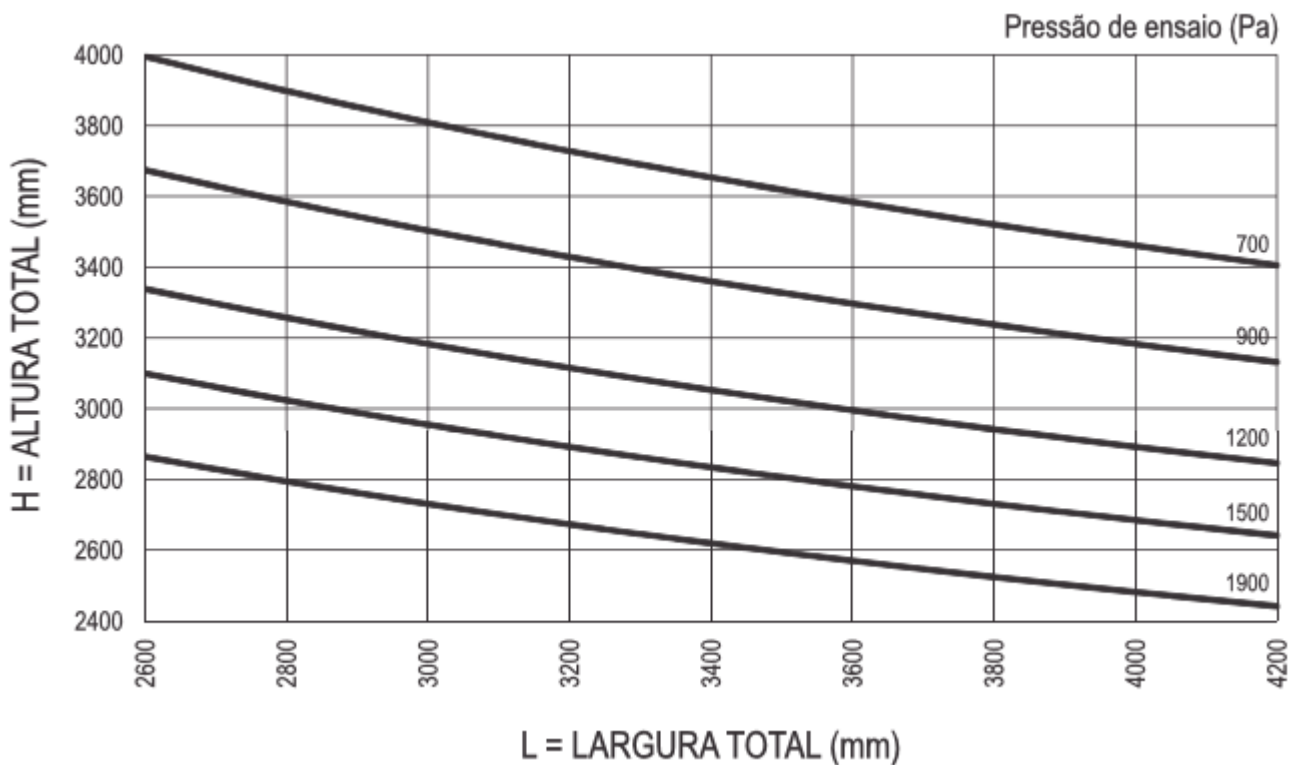
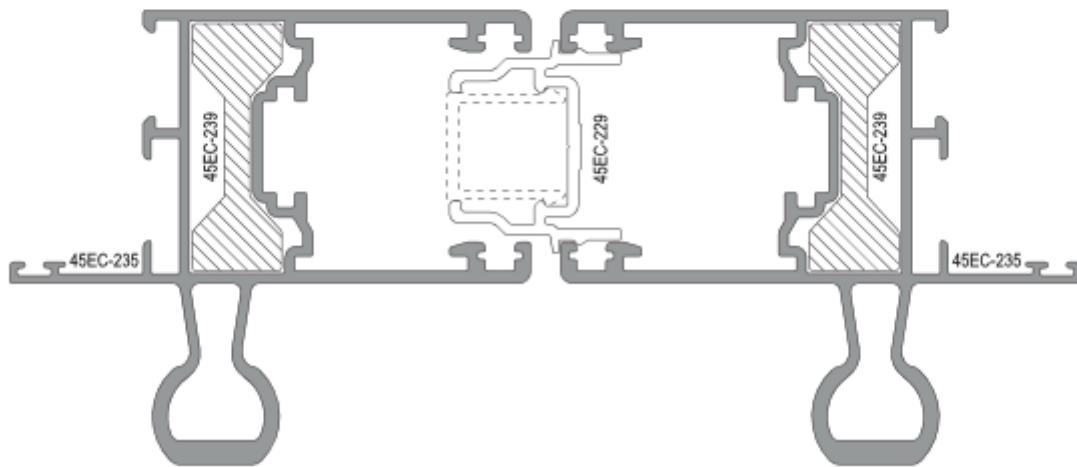
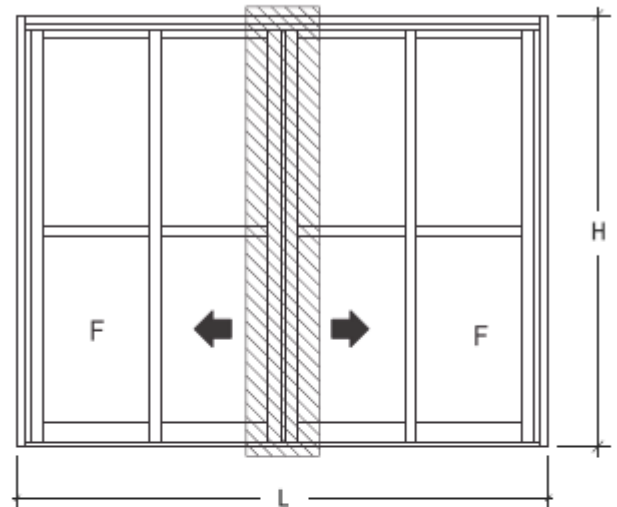
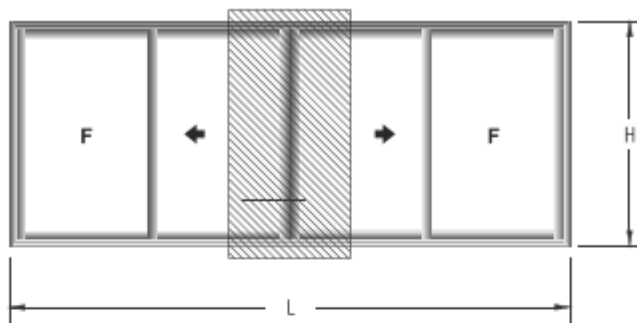

DIAGRAMA DE DIMENSÕES

JANELA DE CORRER 4 FOLHAS

<p>45EC-234</p> <p>Jx = 17,252 cm⁴</p> <p>Jy = 24,748 cm⁴</p> <p>Wx = 7,146 cm³</p> <p>Wy = 5,194 cm³</p>	<p>45EC-234</p> <p>Jx = 17,252 cm⁴</p> <p>Jy = 24,748 cm⁴</p> <p>Wx = 7,146 cm³</p> <p>Wy = 5,194 cm³</p>
<p>Jx Total = 34,504 cm⁴ (perfil 45EC-229 não considerado no cálculo)</p>	

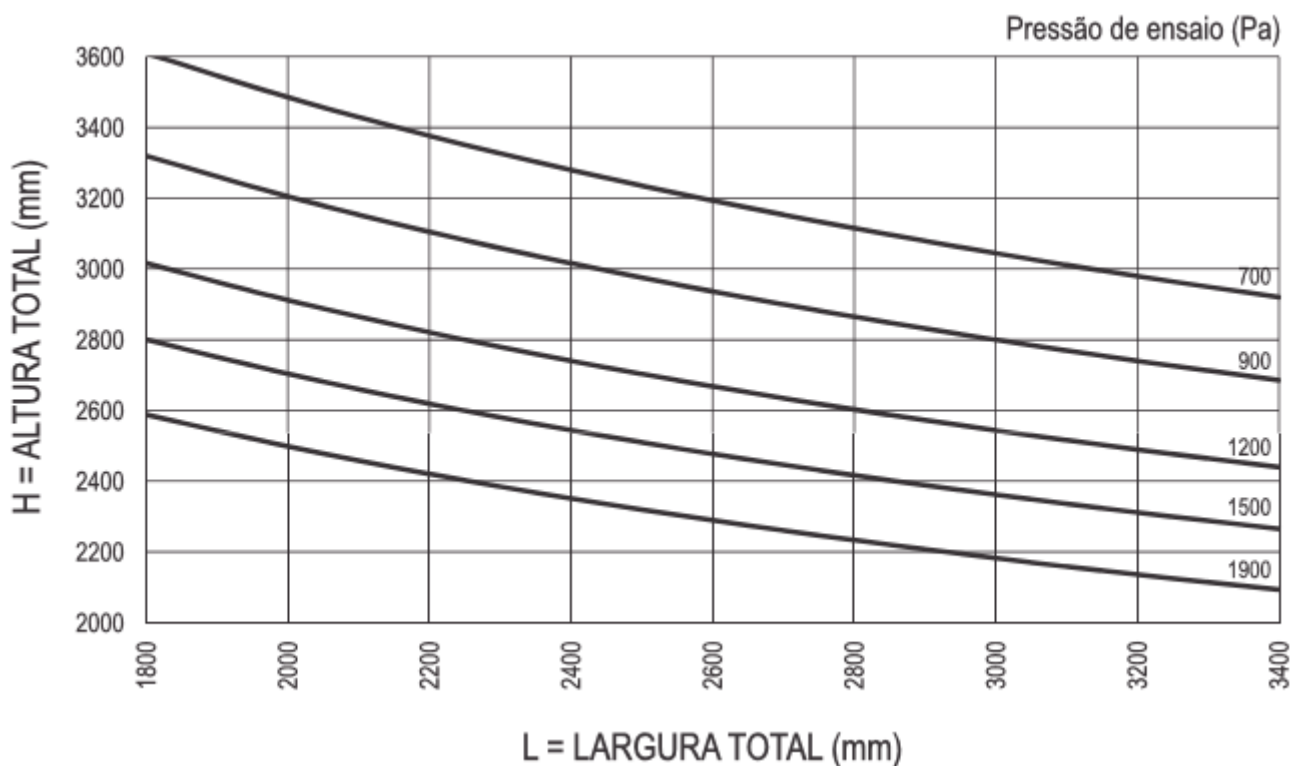
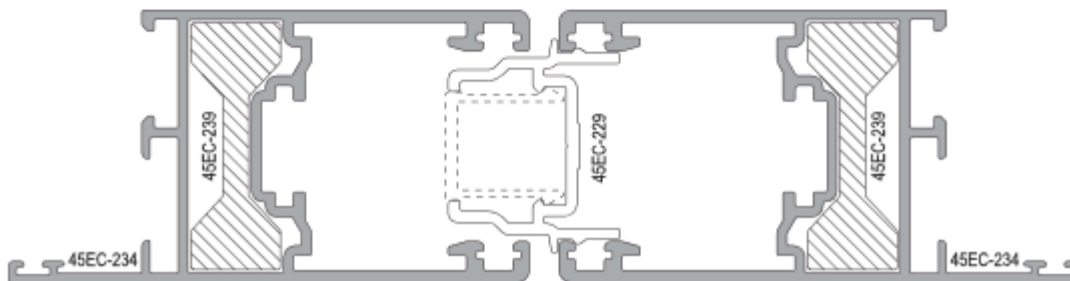

DIAGRAMA DE DIMENSÕES

PORTA DE CORRER 2 FOLHAS



45EC-270	45EC-270
$J_x = 20,336 \text{ cm}^4$	$J_x = 20,336 \text{ cm}^4$
$J_y = 38,912 \text{ cm}^4$	$J_y = 38,912 \text{ cm}^4$
$W_x = 8,526 \text{ cm}^3$	$W_x = 8,526 \text{ cm}^3$
$W_y = 7,215 \text{ cm}^3$	$W_y = 7,215 \text{ cm}^3$
$J_x \text{ Total} = 40,672 \text{ cm}^4$	

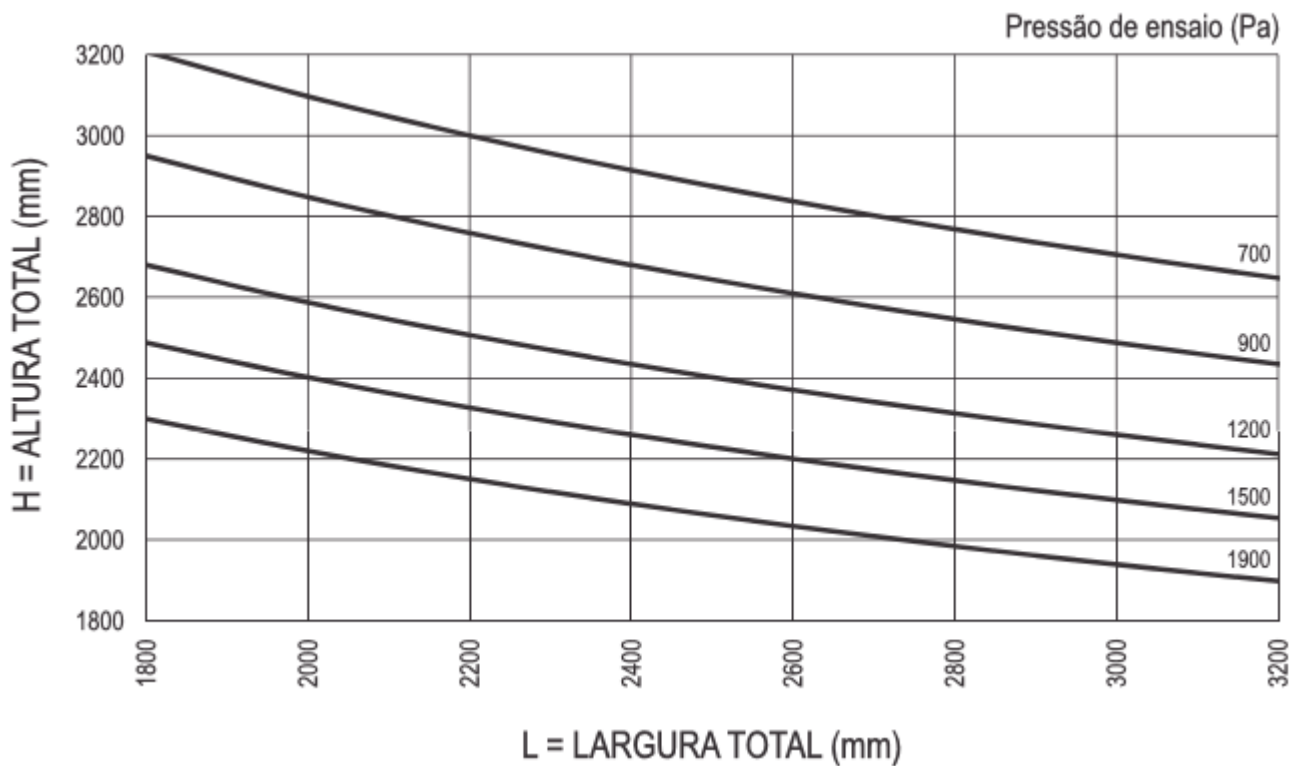
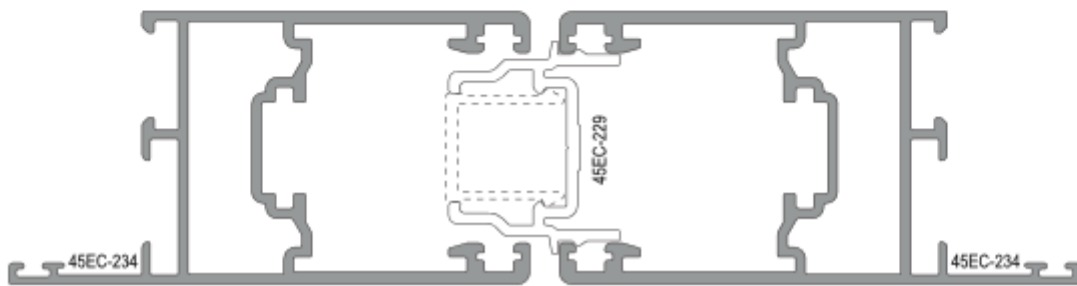
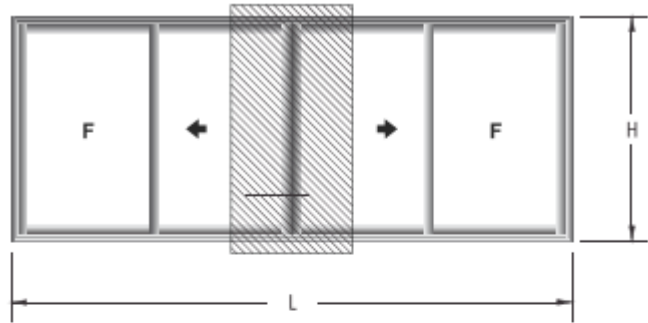
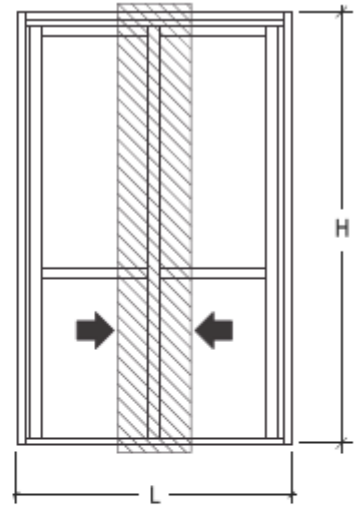
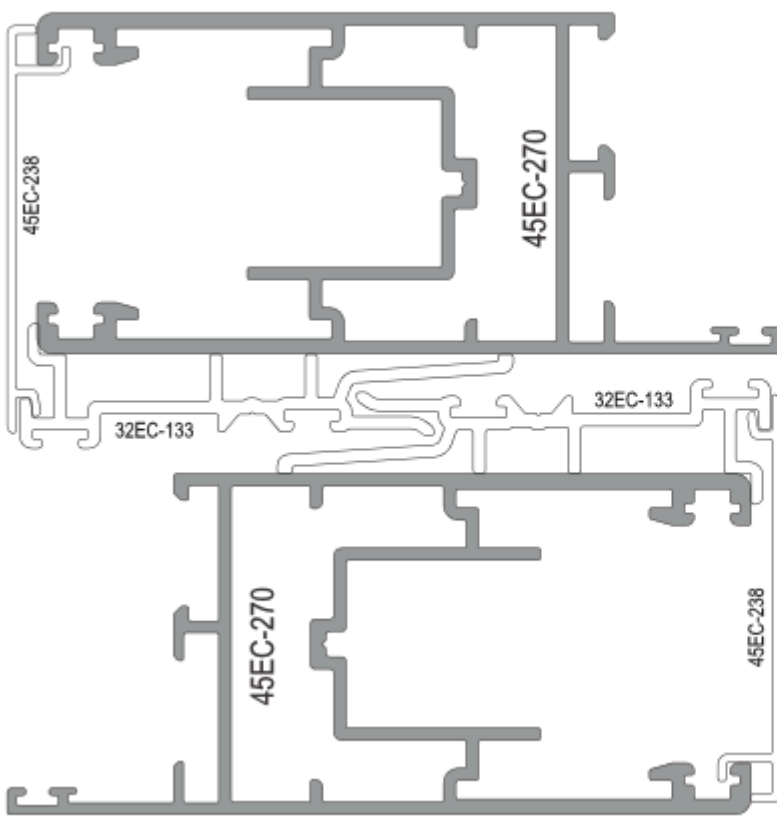

DIAGRAMA DE DIMENSÕES

PORTA DE CORRER 2 FOLHAS



45EC-270	45EC-270
$J_x = 20,336 \text{ cm}^4$	$J_x = 20,336 \text{ cm}^4$
$J_y = 38,912 \text{ cm}^4$	$J_y = 38,912 \text{ cm}^4$
$W_x = 8,526 \text{ cm}^3$	$W_x = 8,526 \text{ cm}^3$
$W_y = 7,215 \text{ cm}^3$	$W_y = 7,215 \text{ cm}^3$
$J_x \text{ Total} = 40,672 \text{ cm}^4$	

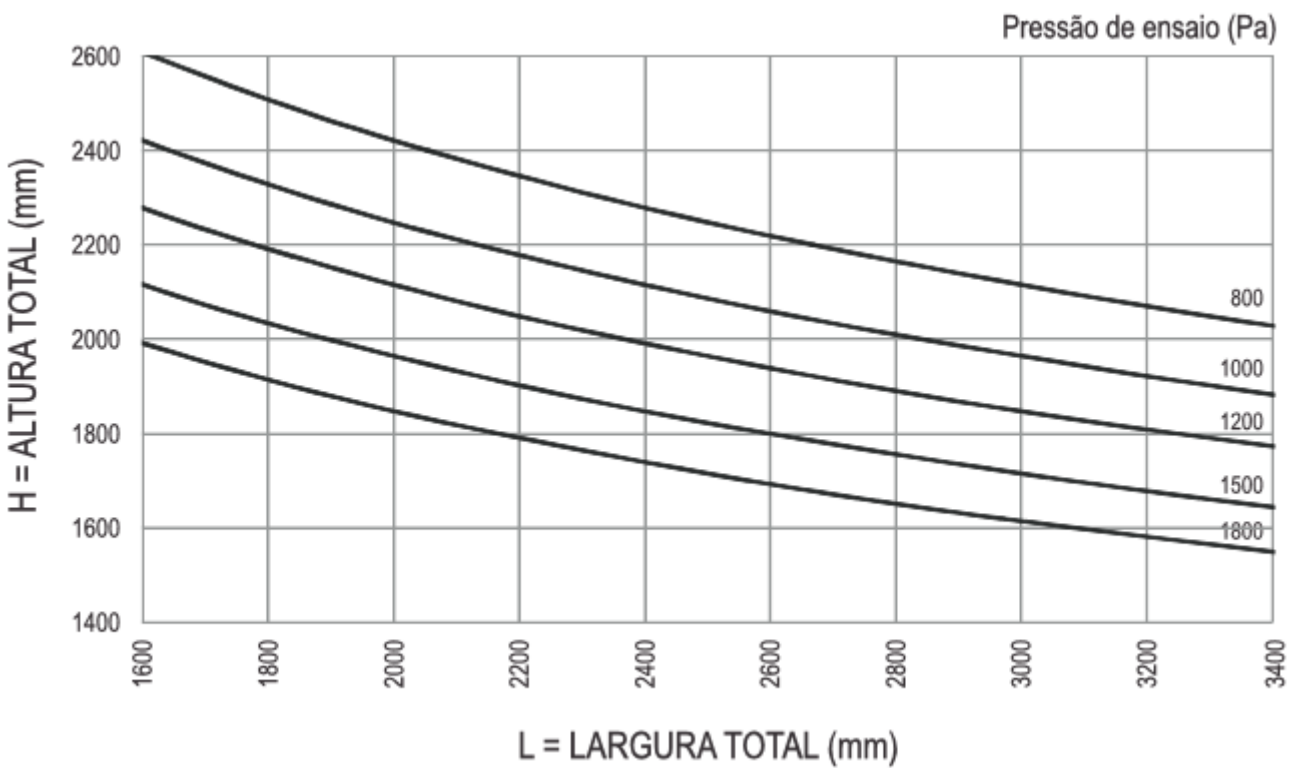
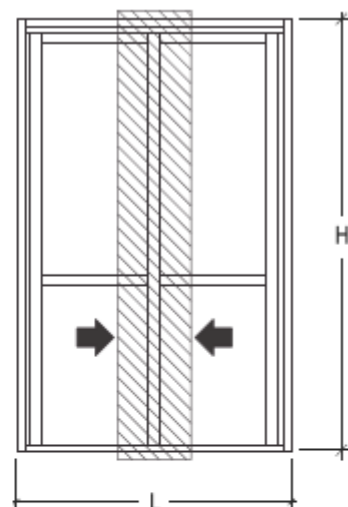
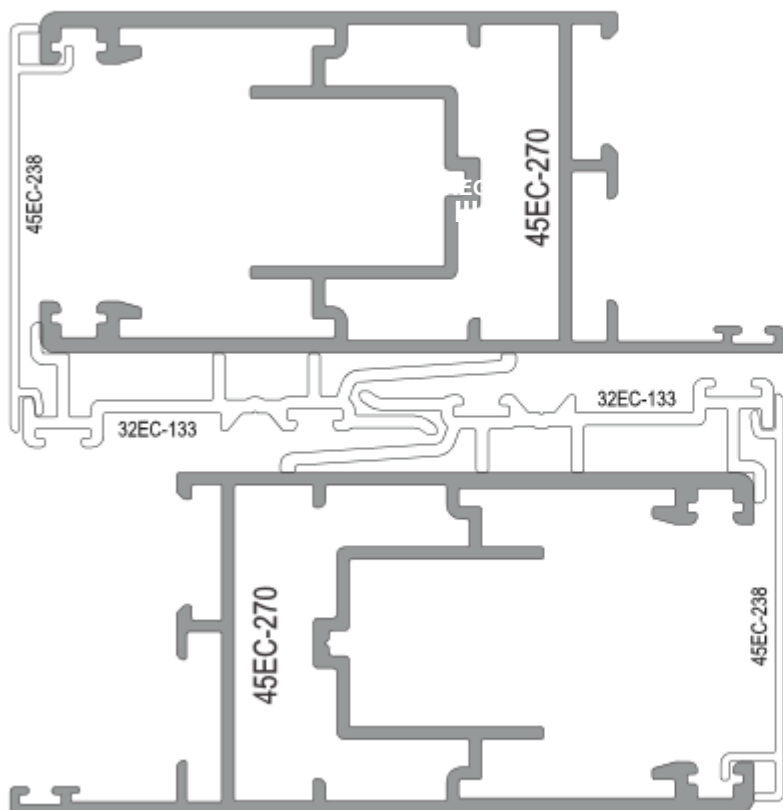

DIAGRAMA DE DIMENSÕES

PORTA DE CORRER 2 FOLHAS



45EC-270	45EC-271
Jx = 20,336 cm ⁴	Jx = 48,561 cm ⁴
Jy = 38,912 cm ⁴	Jy = 45,314 cm ⁴
Wx = 8,526 cm ³	Wx = 10,994 cm ³
Wy = 7,215 cm ³	Wy = 9,159 cm ³
Jx Total = 68,897 cm ⁴	

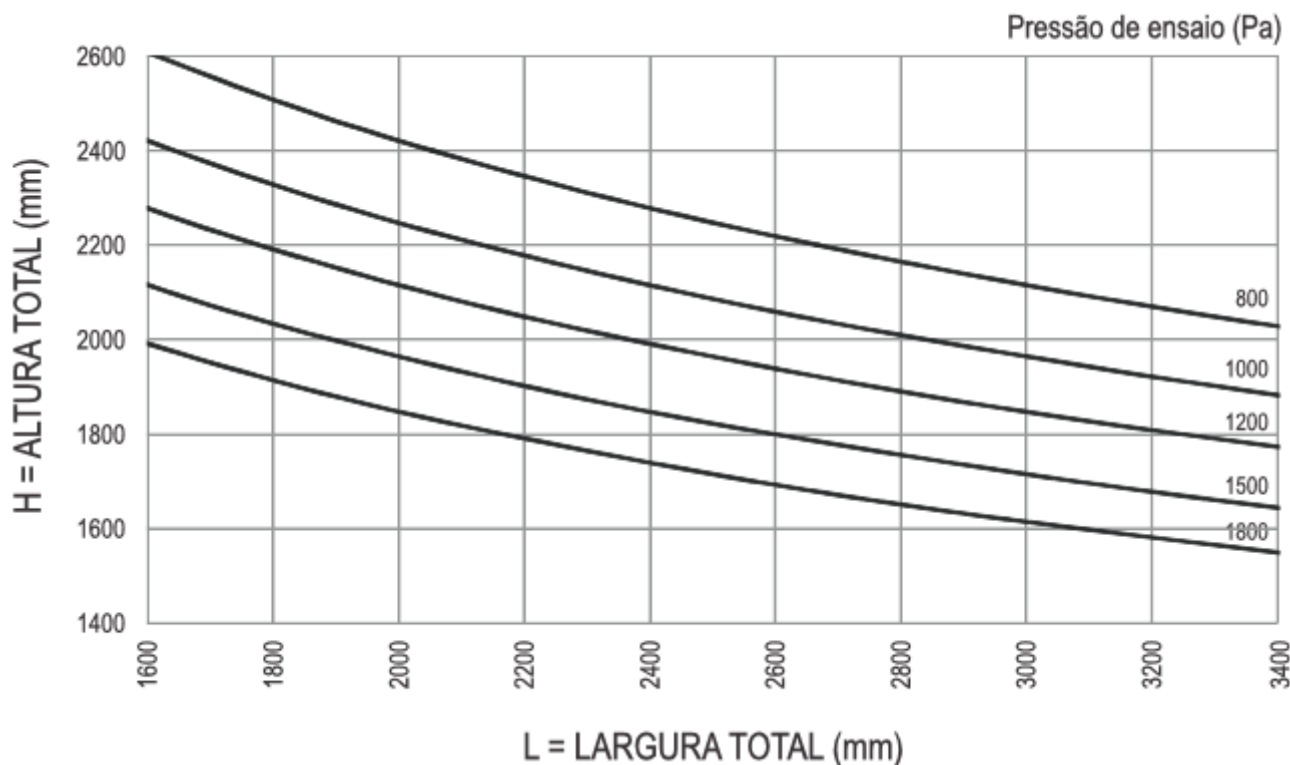
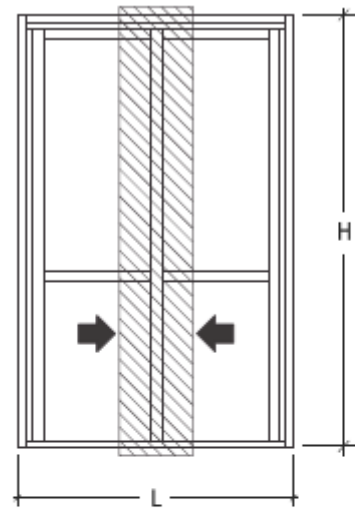
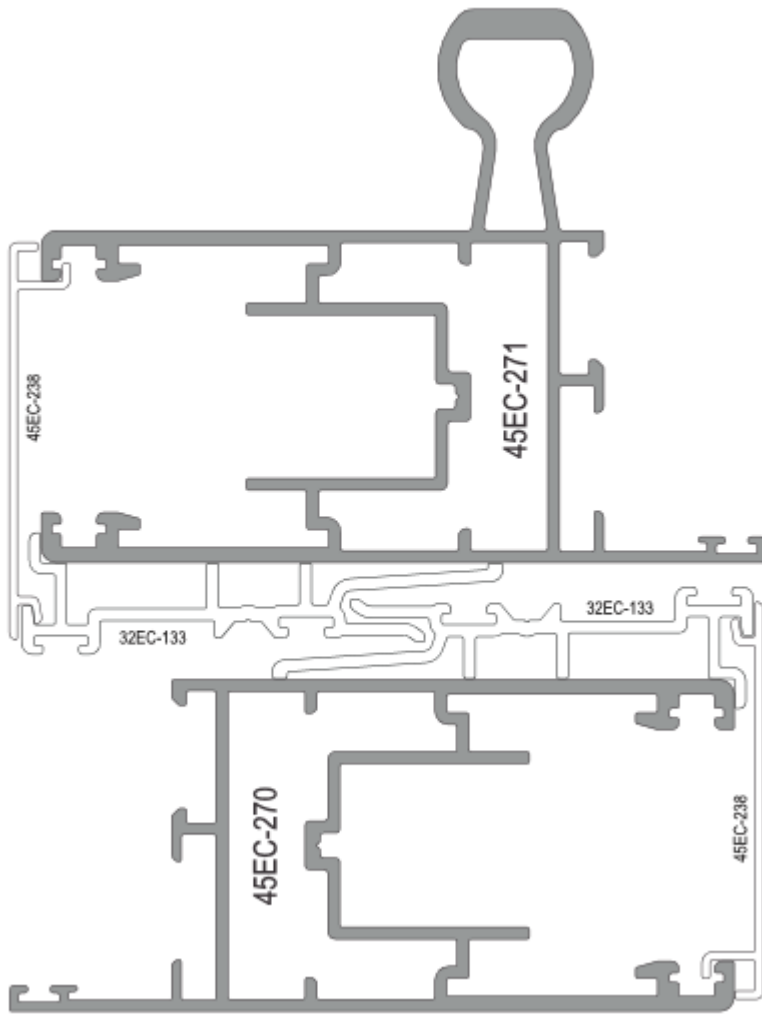

DIAGRAMA DE DIMENSÕES

PORTA DE CORRER 2 FOLHAS



45EC-271	45EC-272
$J_x = 48,561 \text{ cm}^4$	$J_x = 45,302 \text{ cm}^4$
$J_y = 45,314 \text{ cm}^4$	$J_y = 45,314 \text{ cm}^4$
$W_x = 10,994 \text{ cm}^3$	$W_x = 10,740 \text{ cm}^3$
$W_y = 9,159 \text{ cm}^3$	$W_y = 9,159 \text{ cm}^3$
$J_x \text{ Total} = 93,863 \text{ cm}^4$	

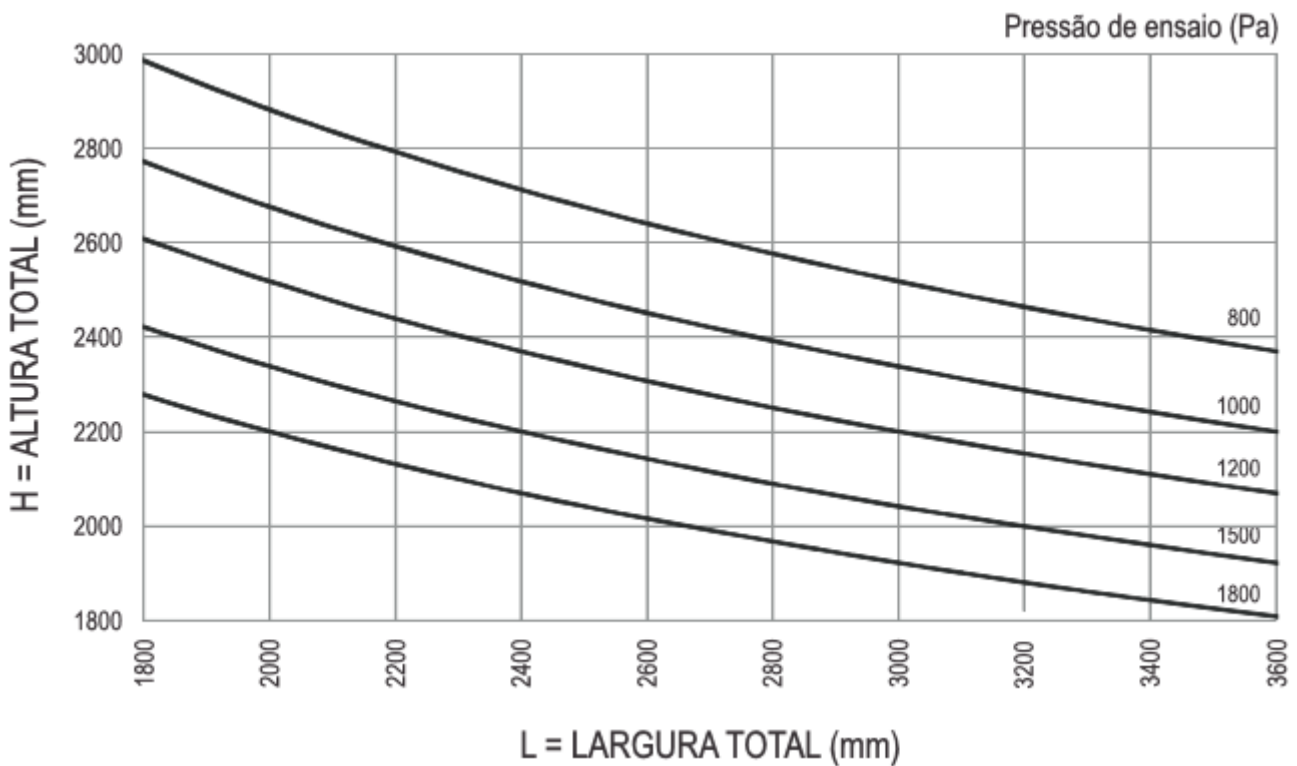
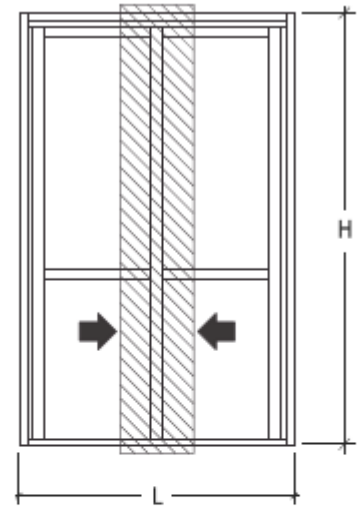
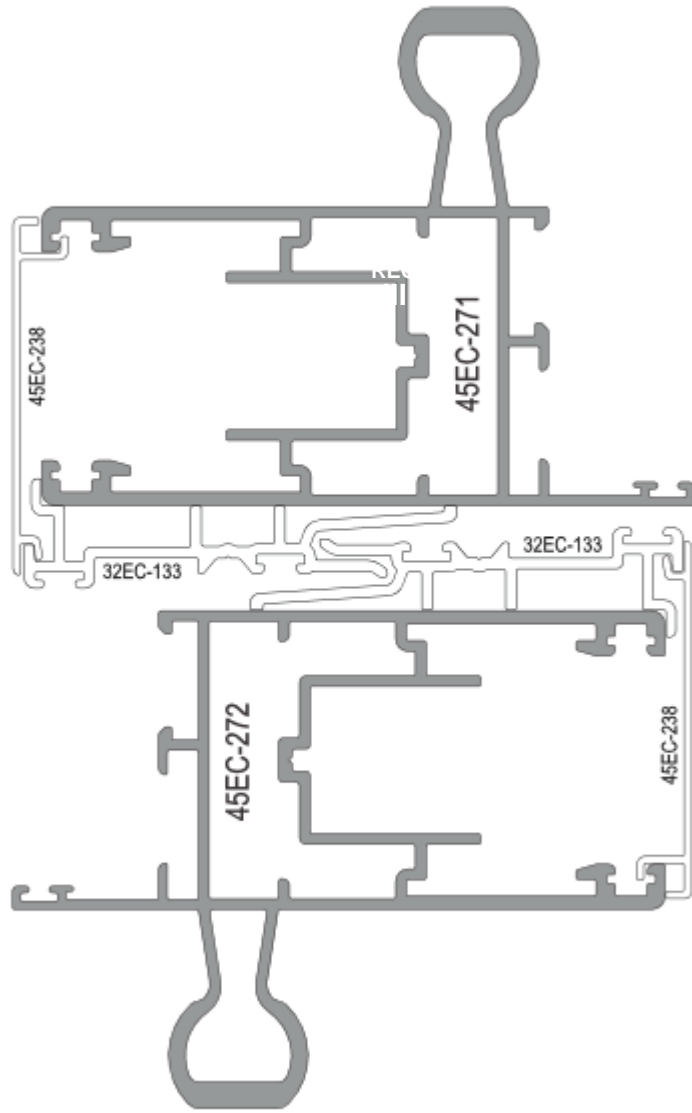
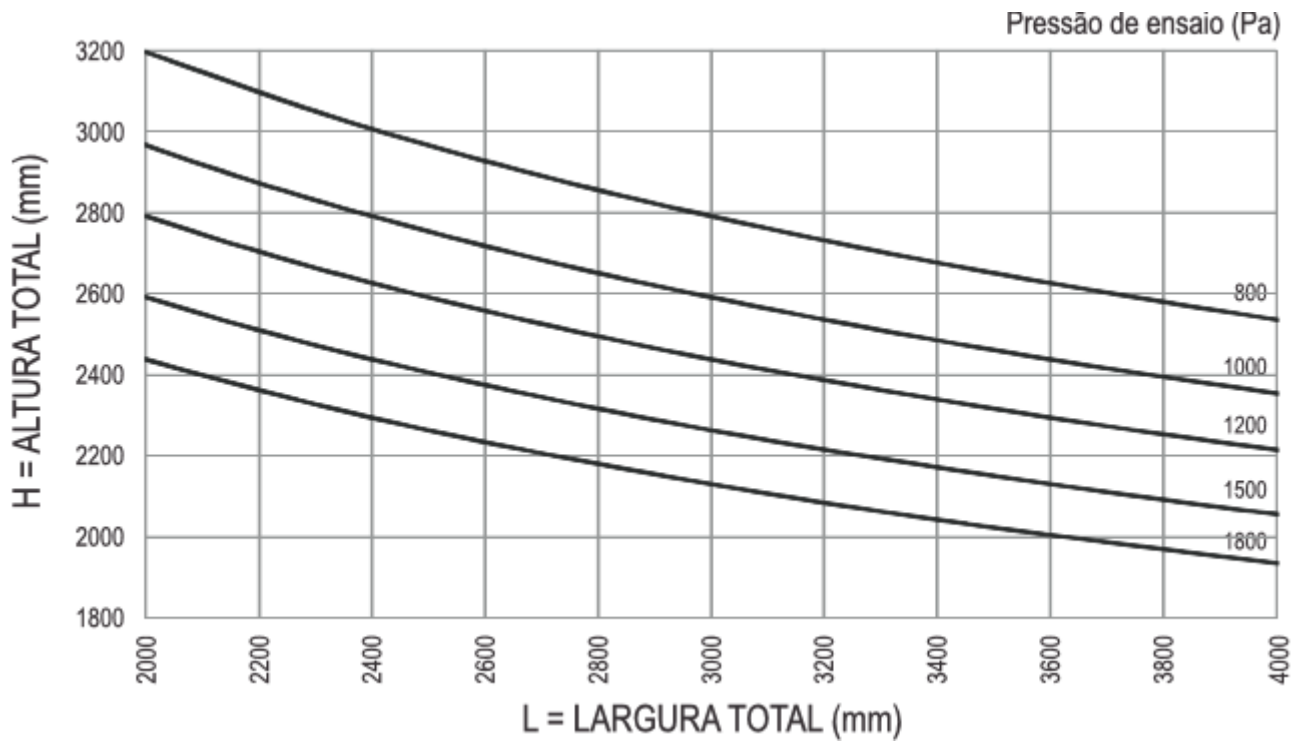

Janela Maxim-ar 01 folha

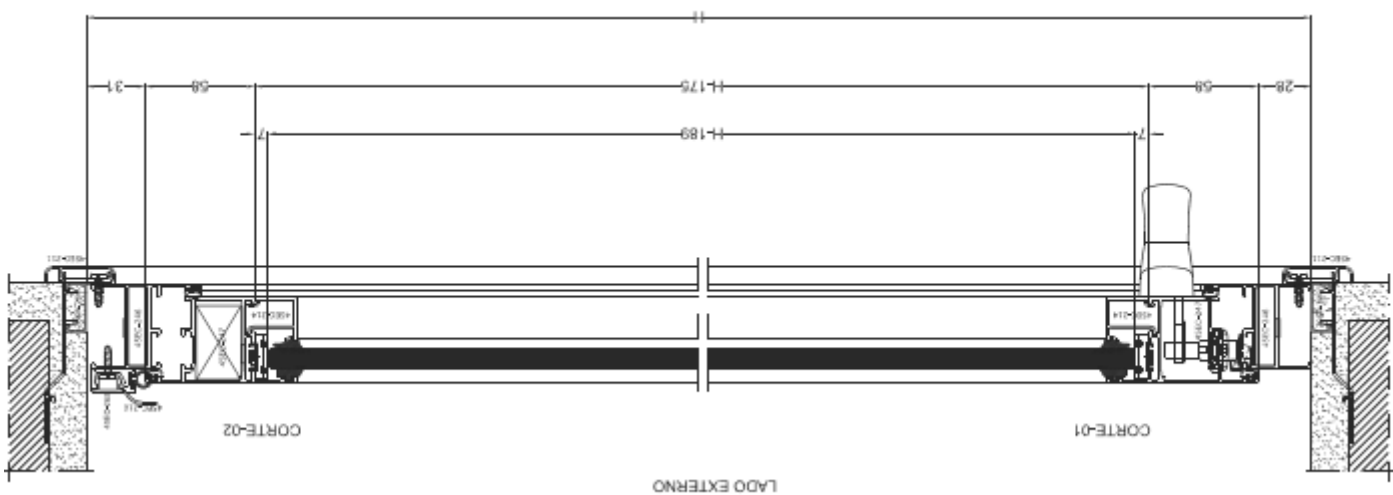
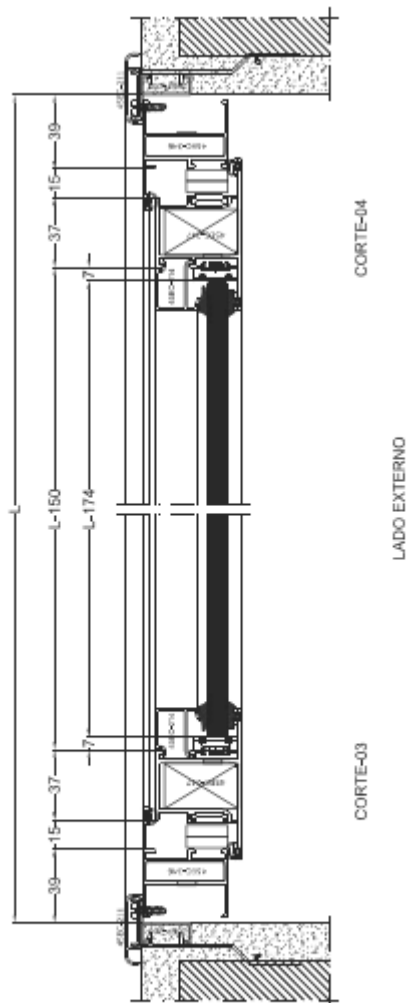
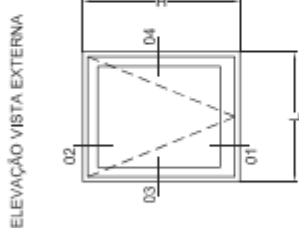

Janela de Oscilobatente 01 folha

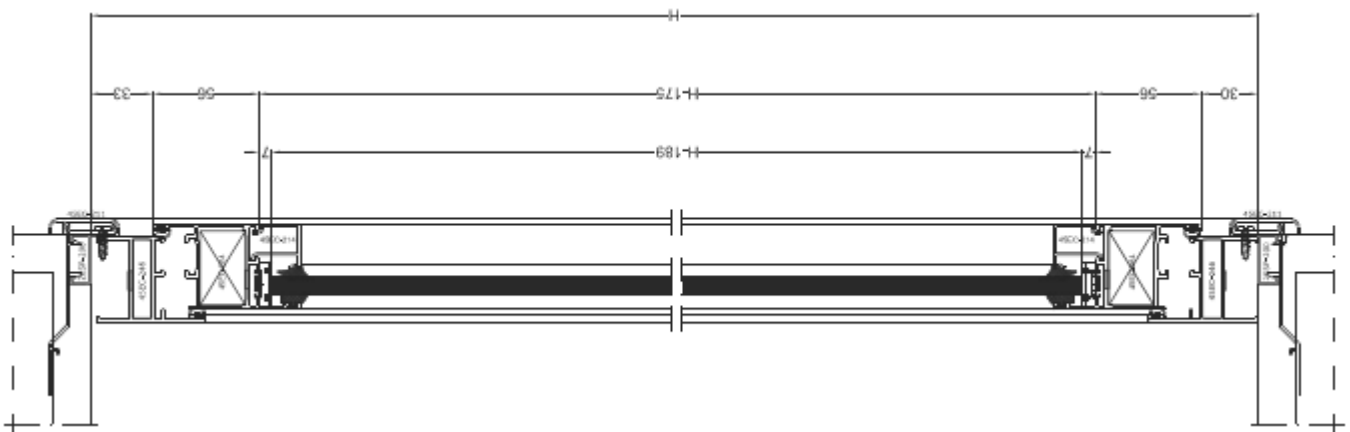
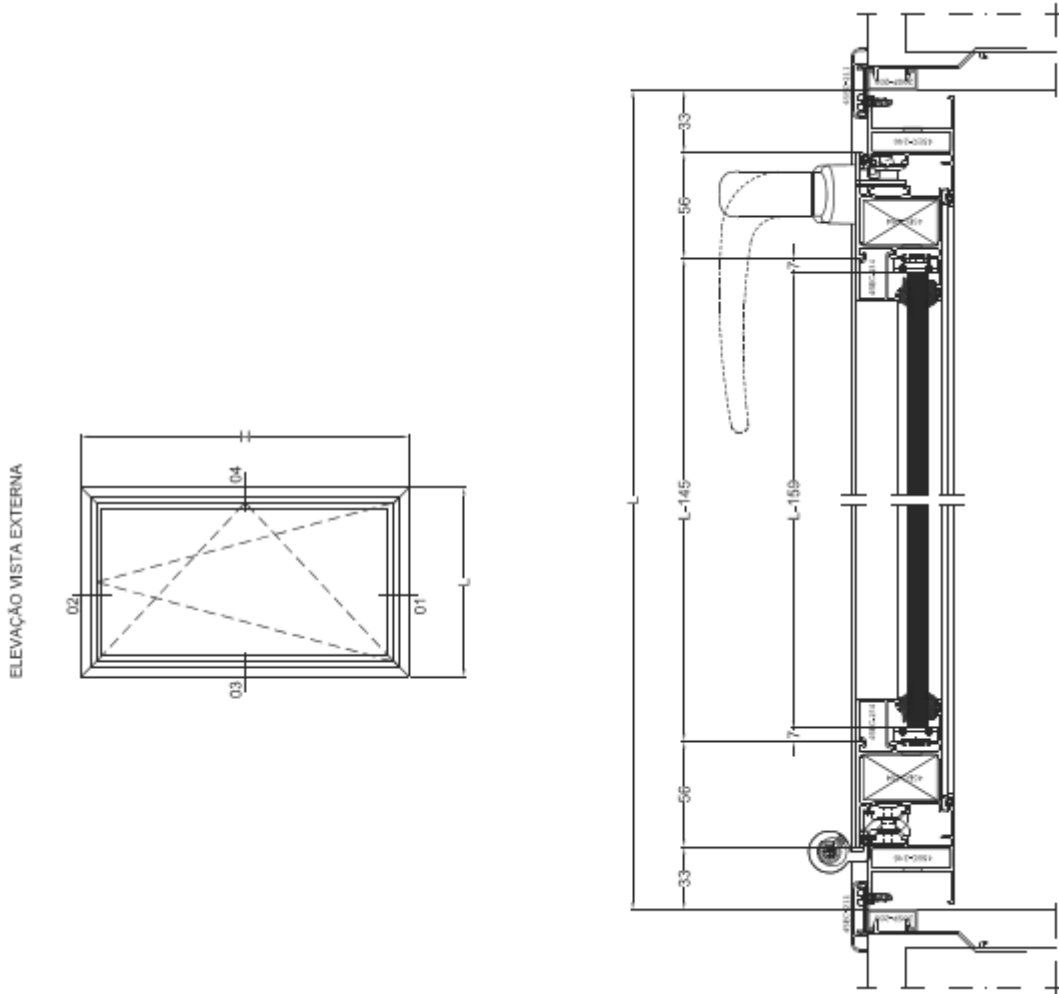

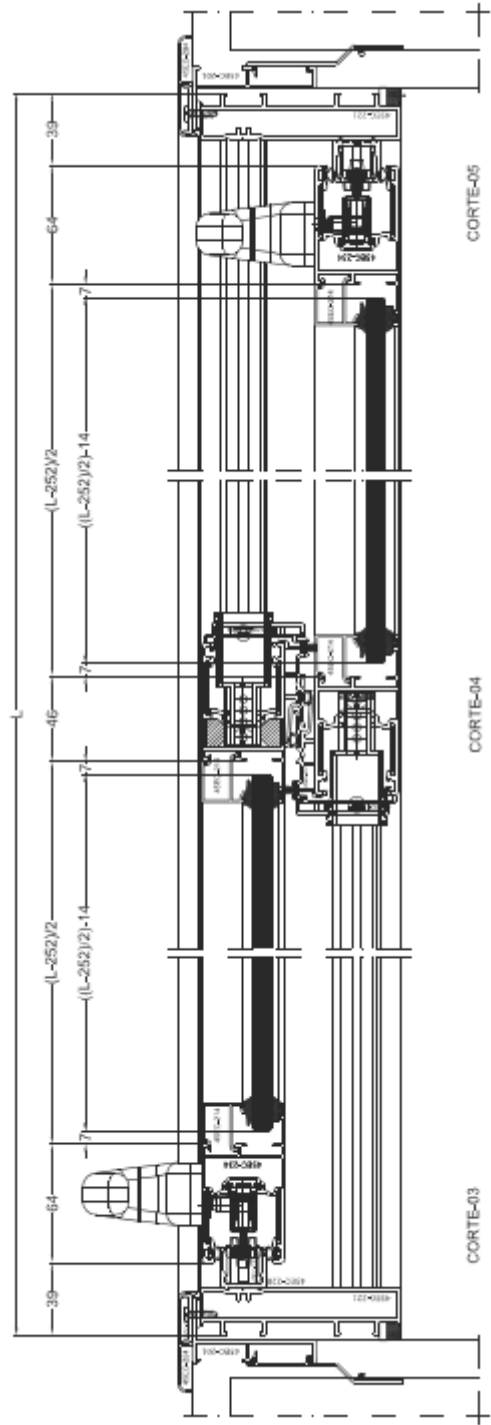
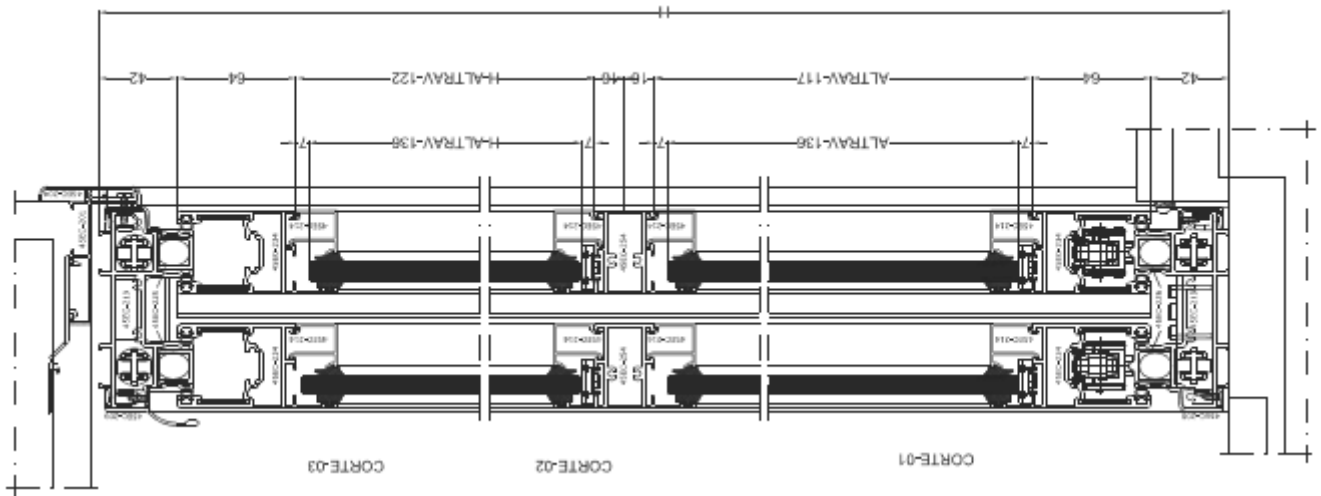
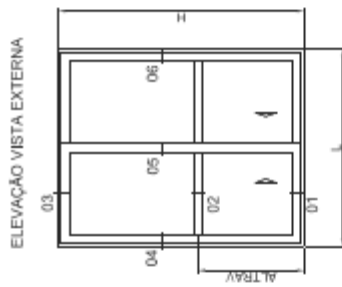

*dimensões em milímetros

Porta de Correr 02 Folhas com Travessa



*dimensões em milímetros

aluminorte		INFORMATIVO DE SISTEMAS ALUMINORTE				SP-EURO45		
TIPOLOGIA	CROQUI	NBR 10.821 / 2017			NBR. 15575 / 2021			
		RESISTENCIA	ESTANQUEIDADE	DIMENSÕES	ANO	ACÚSTICA	DIMENSÕES	ANO
Porta Integrada 02 folhas com travessa		Região IV - (30 pav = 90m)	300Pa	1595 x 2390	*2011	38dB		
Porta Integrada 02 folhas com travessa						31dB	1500 x 2300 ESTIMATIVA	
Porta Integrada 02 folhas com travessa						38dB	1500 x 2300 ESTIMATIVA	

Obrigado,

Desde 1986
aluminorte
alumínio e acessórios

Conheça os nossos
sistemas no site:
Acesse o qr code e confira!



Nos acompanhe nas
redes sociais e fique
por dentro!
@aluminorte

Ou entre em contato pelo telefone:
22814822