

L I N H A S E X C L U S I V A S

I N T E G R A D A S U P R E M A

L E V E

SUPREMA LEVE

REDUÇÃO DE 32%* NO PESO DA
CAIXA DA INTEGRADA



A INTEGRADA 25 MAIS LEVE DO
MERCADO



MAIOR PRODUTIVIDADE
COM MENOR CUSTO



FACILIDADE NA
MONTAGEM

* Vide página 09 deste catálogo.

SOLICITE SEU
ORÇAMENTO



ÍNDICE DE PERFIS _____	01
PERFIS _____	02
COMPONENTES _____	08
CÁLCULO COMPARATIVO _____	09



ÍNDICE DE PERFIS

CÓDIGO	PESO	PÁG
20SP – M42	0,687 Kg/m	06
20SP – M46	0,803 Kg/m	06
20SP – M47	0,833 Kg/m	06
20SP – M48	1,104 Kg/m	07
20SP – M49	1,084 Kg/m	07
20SP – M50	0,617 Kg/m	07
20SP – M51	0,766 Kg/m	07
DS – 238	0,521 Kg/m	05
MN – 015	0,881 Kg/m	05
MN – 055	0,371 Kg/m	05
SPI – I04	0,687 Kg/m	05
SPI – I06	0,910 Kg/m	02
SPI – I07	0,883 Kg/m	02
SPI – I08	1,287 Kg/m	02
SPI – M11	0,559 Kg/m	03
SPI – M14	0,893 Kg/m	04
SPI – M16	0,698 Kg/m	04
SPI – M17	0,994 Kg/m	04
SPI – M98	1,149 Kg/m	03
SPI – M99	0,765 Kg/m	03

TRILHO

SPI – I06

Trilho Inferior
0,910 Kg/m

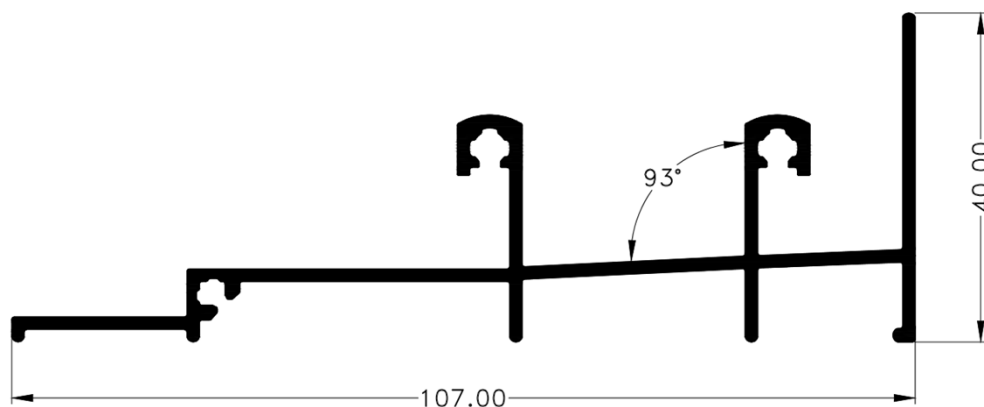

SPI – I07

Trilho Intermediário
0,883 Kg/m

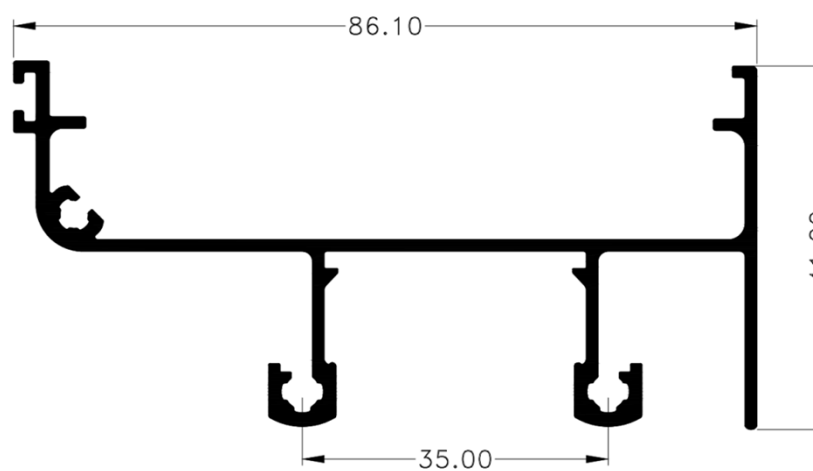

SPI – I08

Trilho Intermediário
1,287 Kg/m

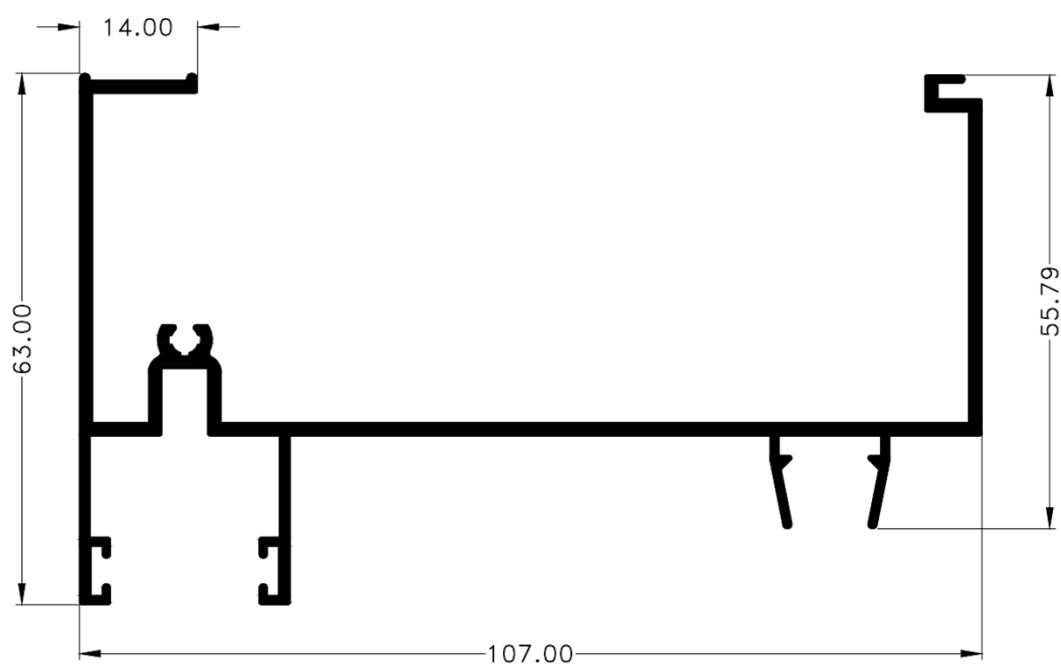

MARCO E TAMPAS

SPI – M11

Marco lateral
0,559 Kg/m

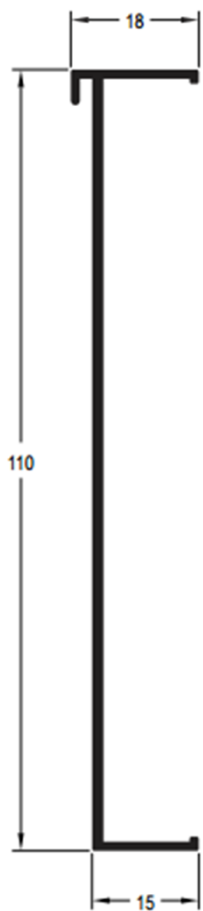

SPI – M98

Tampa interna
1,149 Kg/m

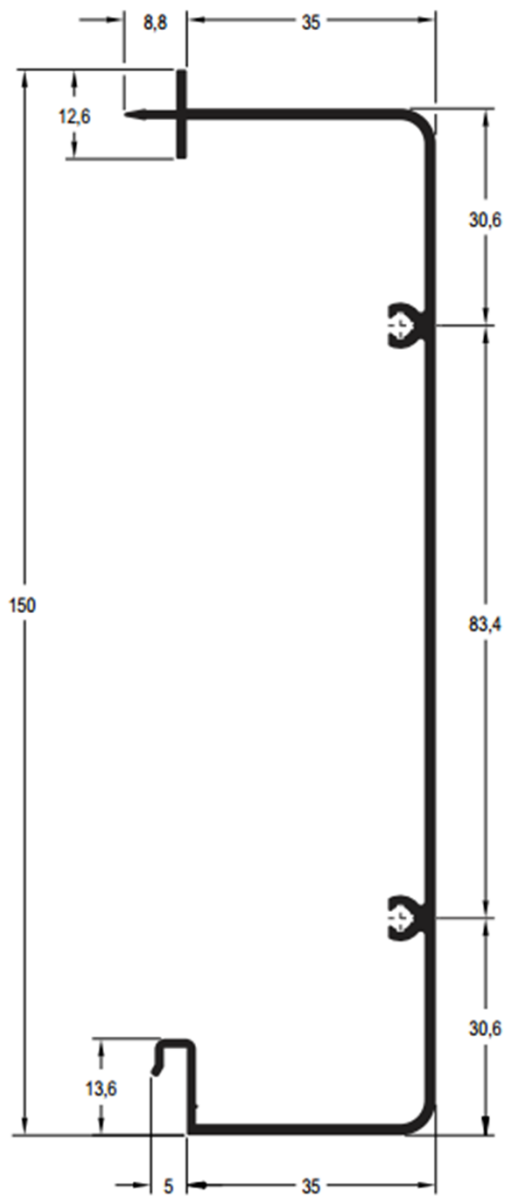

SPI – M99

Tampa externa
0,765 Kg/m

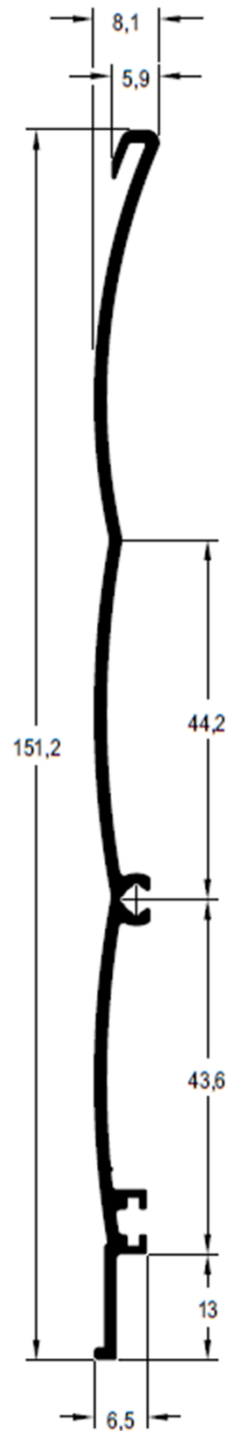

*dimensões em milímetros

SPI – M14

Marco superior
0,893 Kg/m

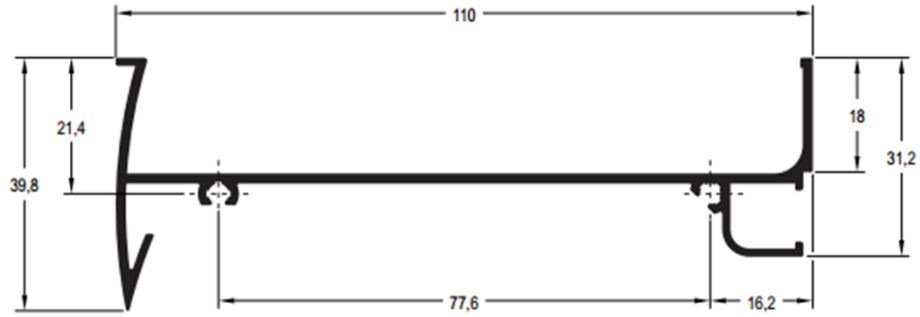

SPI – M16

Tampa externa
0,698 Kg/m



SPI – M17

Tampa interna
0,994 Kg/m

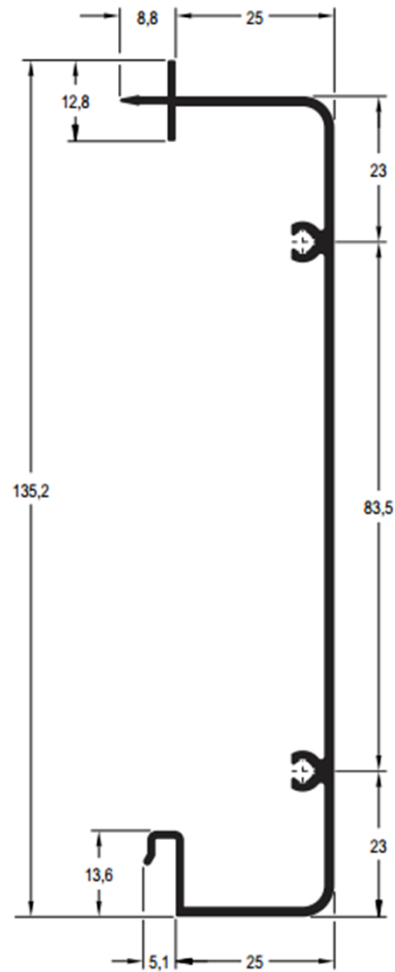

COMPLEMENTOS (INTEGRADA)

SPI - I04

Guia lateral
0,687 Kg/m

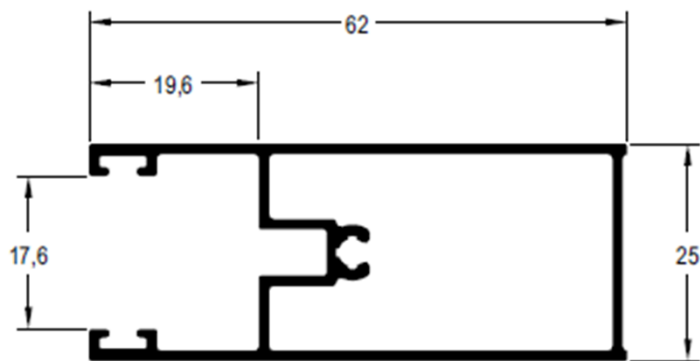

DS - 238

Arremate
0,521 Kg/m

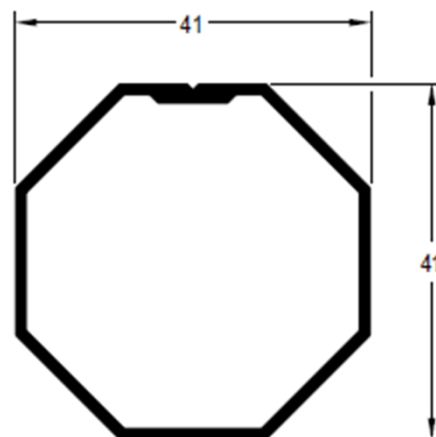

MN - 055

Terminal da persiana
0,371 Kg/m

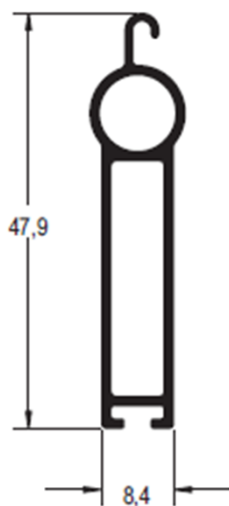

MN - 015

Tubo recolhedor
0,881 Kg/m

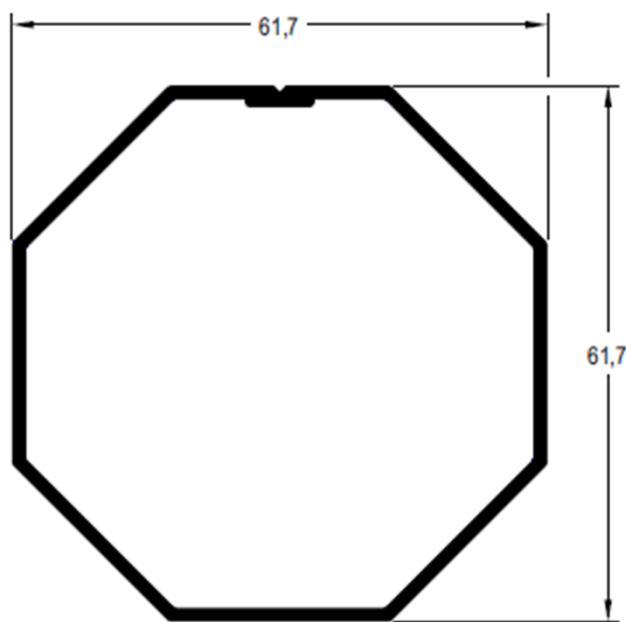

20SP – M42

Marco Lateral
0,687 Kg/m

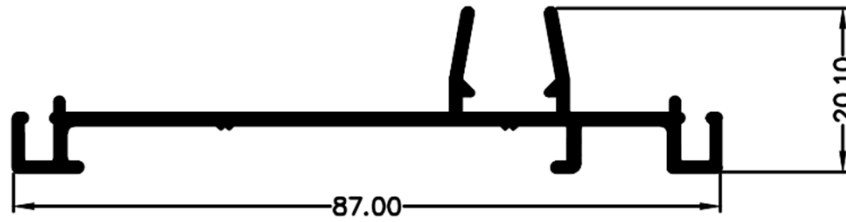

20SP – M46

Marco Inferior
0,803 Kg/m

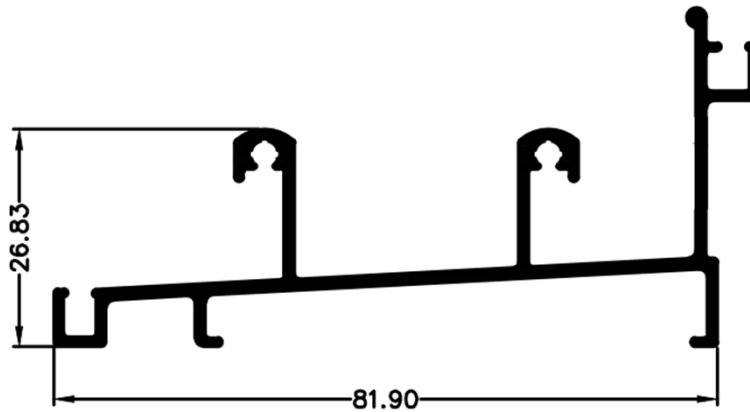

20SP – M47

Marco Superior
0,833 Kg/m

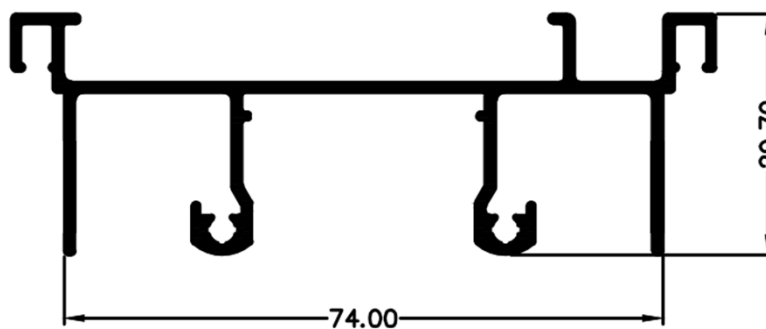

20SP – M48

Marco Superior 3 Planos
1,104 Kg/m

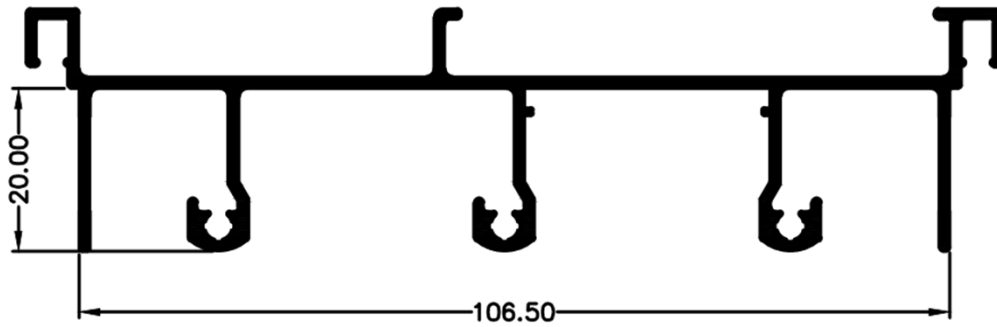

20SP – M49

Marco Inferior 3 Planos
1,084 Kg/m

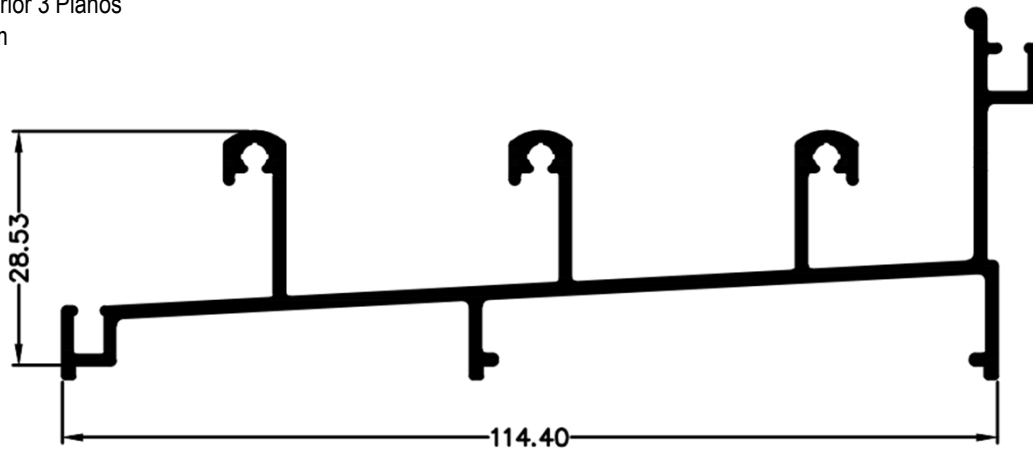

20SP – M50

Marco lateral 3 planos
0,617 Kg/m

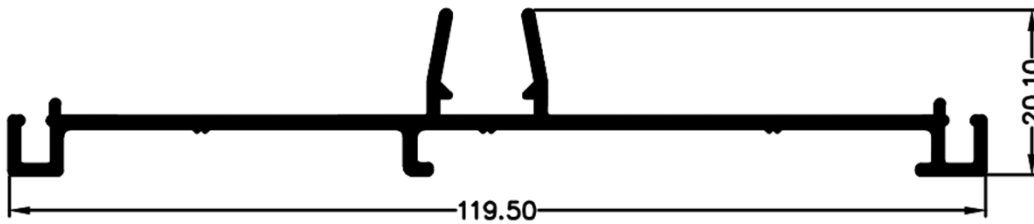

20SP – M51

Marco lateral 3 planos
0,766 Kg/m

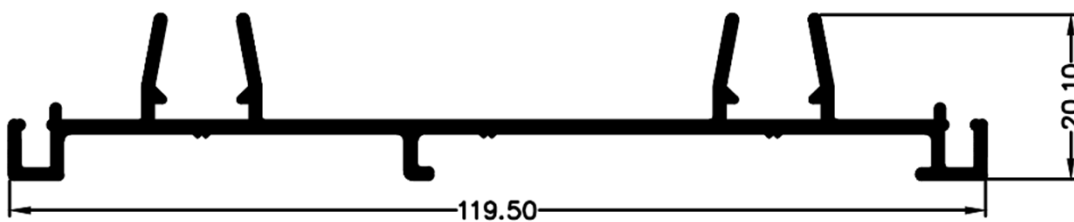

ACESSÓRIO	CÓDIGO	DESCRIÇÃO
	FIT – 214	Escova de Vedação 7x10mm
	GUICININFALC	Guia Cinta Recolhedor Inferior REC011 / REC013 - Udinese
	NYL – 369	Guia Limitador Soleira Esteira Integrada Nylon (GUI28)
	NYL – 370	Guia Persiana Esteira (GUI29)
	NYL – 601D	Tampa Lateral Direita da Caixa
	NYL – 601E	Tampa Lateral Esquerda da Caixa
	PRE – 04	Presilha para Esteira Linha Integrada
	REC – 011	Recolhedor Fita 20mm com Mola Retorno Nylon - Udinese
	RECAPD 60	Kit Acessórios Tubo Octogonal 60mm

CÁLCULO COMPARATIVO

CAIXA DA JANELA INTEGRADA SUPREMA DE MERCADO					
PERFIL	PESO (Kg/m)	COMP. (m)	TOTAL (Kg)	QTDE.	TOTAL POR PERFIL (Kg)
MN - 001	1,377	0,956	1,316412	1	1,316412
MN - 002	0,669	0,92	0,61548	1	0,61548
MN - 003	1,093	1	1,093	2	2,186
MN - 007	0,71	0,808	0,57368	2	1,14736
MN - 010	1,495	0,956	1,42922	1	1,42922
MN - 015	0,881	0,956	0,842236	1	0,842236
MN - 031	1,331	0,956	1,272436	1	1,272436
MN - 039	1,4	0,956	1,3384	1	1,3384
MN - 050	0,734	0,808	0,593072	1	0,593072
SU - 001	0,762	0,92	0,70104	1	0,70104
SU - 291	0,263	0,769	0,202247	2	0,404494
TOTAL					11,84615

CAIXA DA JANELA INTEGRADA SUPREMA LEVE ALUMINORTE					
PERFIL	PESO (Kg/m)	COMP. (m)	TOTAL (Kg)	QTDE.	TOTAL POR PERFIL (Kg)
20SP - M19	0,138	0,811	0,111918	1	0,111918
MN - 015	0,881	0,97	0,85457	1	0,85457
SPI - M11	0,599	1	0,599	2	1,198
SPI - M14	0,893	0,97	0,86621	1	0,86621
SPI - M98	1,149	0,97	1,11453	1	1,11453
SPI - M99	0,765	0,97	0,74205	1	0,74205
SPI - I04	0,599	0,832	0,498368	1	0,498368
SPI - I06	0,906	0,926	0,838956	1	0,838956
SPI - I07	0,883	0,926	0,817658	1	0,817658
SPI - I08	1,287	0,838	1,078506	1	1,078506
TOTAL					8,120766

REPRESENTAÇÃO DE 8,12 EM 11,84 = 68,5519 %

PERCENTUAL DE REDUÇÃO DE PESO = 31,4481 %

* Redução de 31,45% no peso da caixa da janela com persiana integrada, conforme as seguintes especificações:

- Cálculos realizados com base em uma janela de 1,0x1,0m

- Comparativo entre as linhas **Suprema 25** de mercado e a **Suprema Leve Aluminorte**.

- **OBS.:** em proporções diferentes, a redução do peso da caixa pode variar para mais ou menos.

- Em janelas onde a altura é igual à largura (quadradas), a taxa de redução de peso será sempre de 31,45%

SUPREMA DE MERCADO = 11,84 Kg

SUPREMA LEVE ALUMINORTE = 8,12 Kg

TAXA DE REDUÇÃO =
31,4481%

aluminorte Desde 1986
alumínio e acessórios

(11) 2281.4822 – contato@aluminorte.com.br
Rua Amazonas da Silva, 1100 – Vila Guilherme – São Paulo

www.aluminorte.com.br

